

Product Range

PE Systems

Utility and Industry

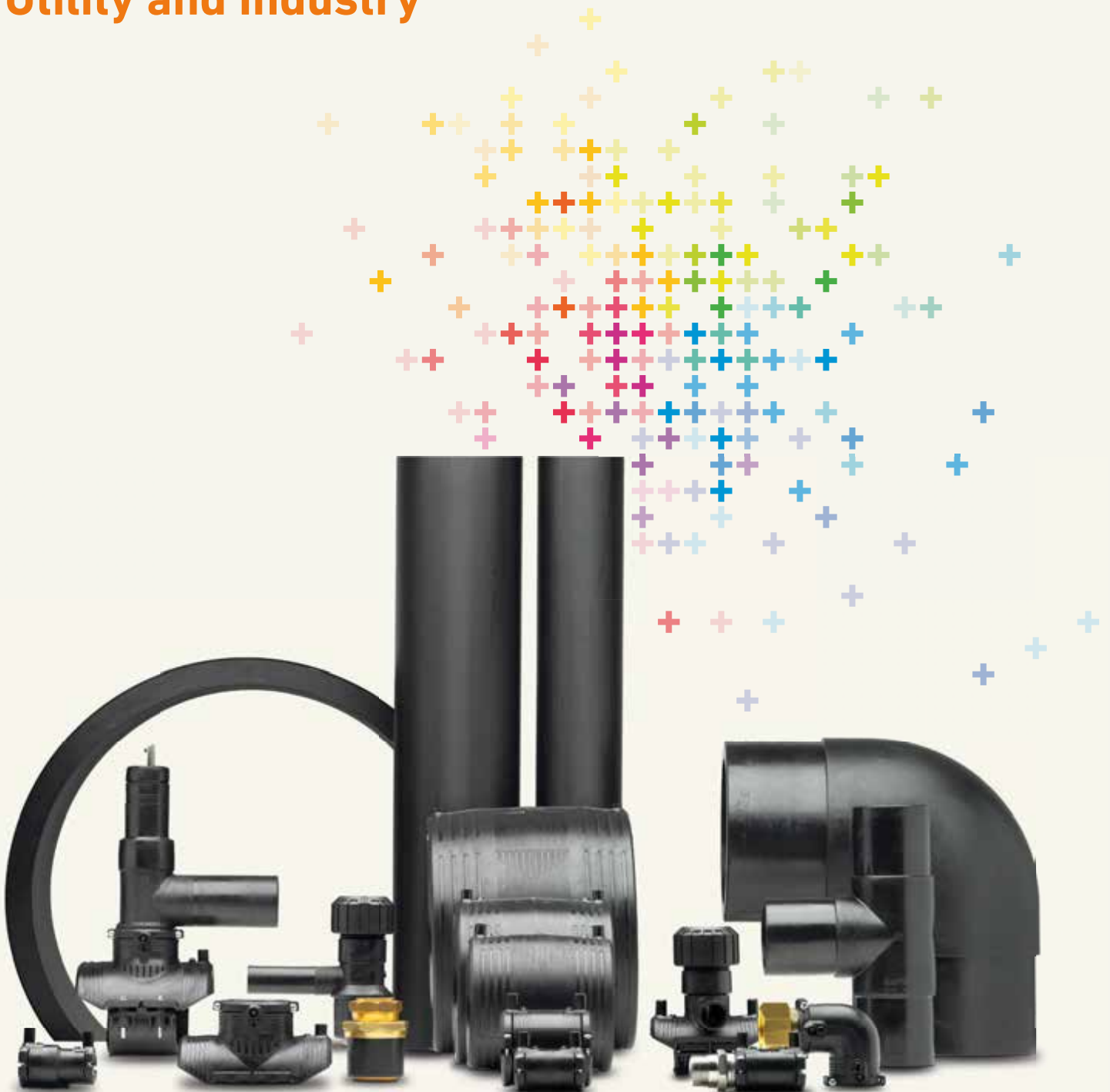

Table of contents

Introduction		4
General information		5
Approvals		6
A lifetime of consistent performance		7
The unique modular electrofusion system		8
Individual service for your needs		9
Value added services		10
Sustainability		12
PE utility range – ELGEF Plus system		14
ELGEF Plus electrofusion fittings	Couplers	17
	Elbows	20
	Tees	22
	Reducers	24
	End caps	26
	Transition fittings	27
	Accessories	32
ELGEF Plus electrofusion saddles	Modular system	34
	Tapping saddles	39
	Pressure tapping valves	49
	Various parts	53
	Accessories & tools	57
ELGEF Plus branch saddles	Branch saddles	59
	Branch saddles toplod	60
	Accessories & tools	63
ELGEF Plus spigot fittings	Elbows	65
	Bends	69
	Tees	76
	Reducers	84
	End caps	87
ELGEF Plus stop-off valves	Ball valves	90
	Extension spindles	91
	Accessories	93

Table of contents

PE industrial range – ecoFIT system		96
ecoFIT pipes		99
ecoFIT socket welding system		103
ecoFIT butt welding system		109
Valves with PE ends	PVC-U body	131
	ABS body	148
	PP body	151
	Valve ends	166
Flanged connections		169
Flanged connections	Flange adaptors long end	171
	Flange adaptors short end	175
	Flanges for butt fusion systems	182
	Flange adaptors for socket fusion systems	189
	Flanges for socket fusion systems	191
	Gaskets	193
FM – Factory Mutual range		200
FM – Factory Mutual range		200
General information		211
Code index		211
General conditions		227





PE Systems

General information

Measures, units and abbreviations

d, d1, d2	Diameter
DN	Nominal diameter
L, L1, L2	Length
H, H1, H2	Height
e, e1, e2	Wall thickness
kg	Weight
SC	Size of bolts
AL	Number of bolt holes
S	Pipe series
SDR	Standard dimension ratio

Packaging

GP	Pieces per bulk pack
pcs. pal.	Pieces per pallet
kg pal.	Weight per pallet
vol. pal.	Volume per pallet (including pallet)

Working pressure

The pressure rating of Georg Fischer PE-Fittings refers to the calculated values of EN 12201 and EN 1555 considering the total security value. National Regulations and standards have to be observed.

Specification

Georg Fischer fittings meet the ISO-standards, CEN-standards (respectively draft standards) as well as other national standards.

Approval

The Georg Fischer products are subjected to extensive internal and external tests and are approved by all major institutes and approval authorities (for example: DVGW, SVGW, KIWA, IIP, engie, Gas Natural, etc.).

General conditions of supply

Please find the general conditions of supply on the last page.

Quality management / environmental management

Quality management system is well established at Georg Fischer and is continuously improved to satisfy our customers. Georg Fischer Piping Systems is certified according to ISO 9001 as well as ISO 14001 (environmental management).

Technical documentation

For further technical information we offer you the Georg Fischer technical manual, the technical dossier and the installation instructions of the products.

Service, training and consultation

Georg Fischer offers you the possibility to do trainings and extend your knowledge in the piping systems field. Please contact your sales company for further information and registrations.

Your partner

Georg Fischer is a world-wide organisation. Please find the address of your Georg Fischer partner on the back cover.

Approvals

GF Piping Systems has always been committed to providing the best quality in products and services. We know that, in more than 100 countries, our solutions are used in vital applications that allow for no failures or unplanned downtimes. Our experts work every day to make sure that you receive the best quality possible. You can trust the products from GF Piping Systems – today and for years to come.

This is expressed in the way we work: quality, safety, and responsibility are implemented in our organization to serve you as well as possible. GF Piping Systems fulfils the ISO 9001, ISO 14001, and OHSAS 18001 standards for quality, environmental, and work safety management. After all, governance and process excellence are essential for quality.

Our products are designed to be safe and easy to install, with lifespans as long as the applications themselves. To ensure this, we subject our products to extensive internal and external tests and reviews. Their outstanding quality is confirmed by the numerous certifications and approvals they have received. These include global and national standards from highly respected organizations and institutions, but also specific customer certifications, as requested.

You will find a selection of product approvals below on this page. Our experts are happy to provide you the certificates you need for your applications and guide you through the applicable systems and standards, as needed. Please contact a GF Piping Systems representative near you, or contact our Global Sales Support team by e-mail at gss@georgfischer.com.



A selection of more than 40 product approvals available, more on request.

A lifetime of consistent performance

The PE (polyethylene) systems of GF Piping Systems convince with their numerous advantages during their long lasting lifetime. The flexible systems cover different applications even under the most challenging conditions and are comprised of easy, quick to install components with the best cost-performance ratio and 100 years estimated lifetime in utility applications. Not only are they reliable under all circumstances but they also contribute to the world's sustainability by having one of the lowest carbon footprints compared to metal or other plastic systems.

+ Efficient

- Best cost-performance ratio
- Light weight, makes installation faster and transportation easier
- Low installation and maintenance costs
- Suitable for trenchless installation techniques

+ Safe & reliable

- 100 years estimated lifetime in utility applications
- Entirely maintenance free
- High chemical resistance
- Impact and abrasion resistance in all weather conditions

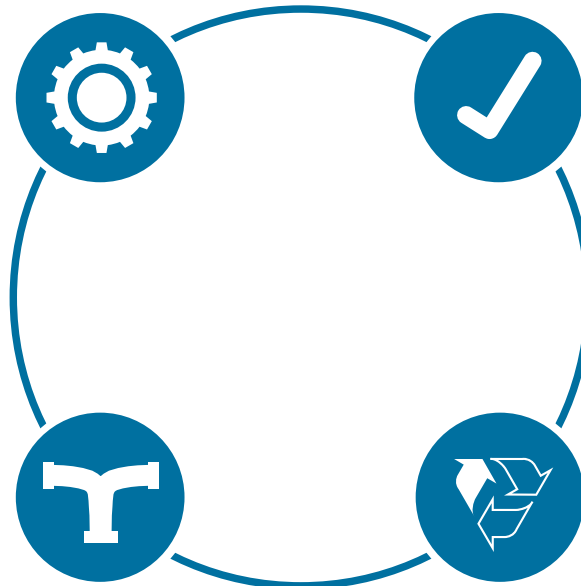

+ Flexible

- Suitable for electro, butt, socket and IR welding
- System solution of fittings up to d2000mm
- Suitable for media between $-50\text{ }^{\circ}\text{C}$ up to $60\text{ }^{\circ}\text{C}$
- Bendable material

+ Sustainable

- Lower carbon footprint compared to metal or other plastic systems
- 100% recyclable

ELGEF Plus – The unique modular electrofusion system

The ELGEF Plus modular saddle system from GF Piping Systems offers you the right kind of connection for every application.

With the ELGEF Plus electrofusion saddle at its core, the installation guarantees ...

- + Speed
- + Simplicity
- + Flexibility



www.gfps.com/video-elgef-saddle

The only
programme
with a modular
system!



Saddle



with tapping tee



with pressure tapping valve



with tapping tee, coupler and ball valve



with transition adaptor



with stop-off adaptor



with spigot and cutter

Individual service for your needs

Customer needs are in the center of whatever GF does. From on-site training to adapted design and tailor-made processes - GF Piping Systems provides individual service which fits customers best.

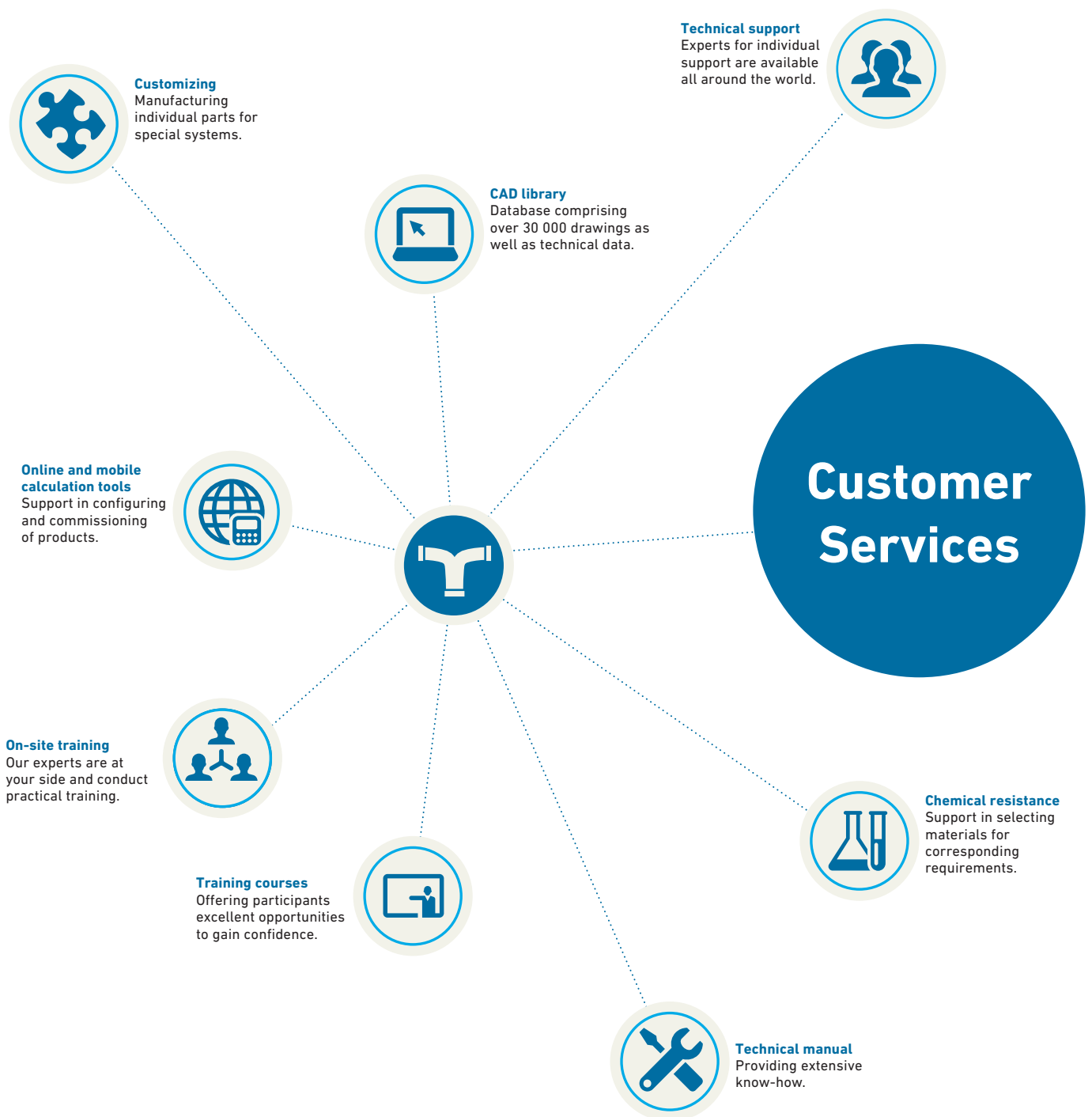

Value added services

From planning support to implementation – our specialists are always close by

As a leading provider of piping systems in plastic and metal, we offer our customers not only reliable products, but also a large package of services. Our support ranges from a comprehensive technical manual or the extensive CAD library to an international team of experts, who work closely together with local sales companies. And when it comes to implementing a project, our customers additionally benefit from a wide range of training courses, either on site or in our modern training centres worldwide.

Generating a genuinely individual added value for our customers is our ultimate goal when implementing our tailor-made solutions. With our application knowledge and product expertise, we support our customers during the planning process, the sustainable realization of the projects and the provision of services. Our expertise in developing and producing piping systems, combined with our profound industry and market knowledge, based on longstanding experience, makes us a qualified and professional partner for our customers.

1 Chemical resistance

Our specialist teams have decades of experience in the area of chemical resistance. They can offer individual support and advice in selecting the right material for the corresponding system solution. On request, a team will examine and select the appropriate material for special applications.

2 CAD library

The extensive CAD library is the most frequently used planning tool at GF Piping Systems. The database comprises over 30 000 drawings and technical data regarding pipes, fittings, measurement and control technology as well as manual and actuated valves. The big advantage of the CAD library is that the data can be integrated directly in CAD models.

3 Technical support

Technical support and material selection are key factors for a successful installation. A team of specialists headquartered in Switzerland is available to support the GF Piping Systems sales companies around the world. For technical advice or for general information, our customers are supported individually by the specialist team in the corresponding sales company.

4 Online and mobile calculation tools

Our numerous, multilingual online calculation tools are very useful for configuring and calculating. By means of pressure/temperature diagrams, the pressure of liquid media recommended for pipes and fittings at various temperatures can be easily defined. FlowCalc App, the mobile application of GF Piping Systems, is an on-site planning tool for pipe diameter and flow velocity calculation to select the right dimension of piping systems when no expert is near by.

5 On-site training

Our experts are available to support our customers locally and conduct training in diverse fusion and jointing techniques on location. The duration and structure of the training depends on the project and the system being installed.

6 Customizing

The customizing teams at GF Piping Systems work closely together around the globe. The focus of these teams is to manufacture custom parts for special systems. In addition, a variety of special solutions can be produced in small series. Standardized processes warrant the highest level of quality for the individual solutions of our customers.

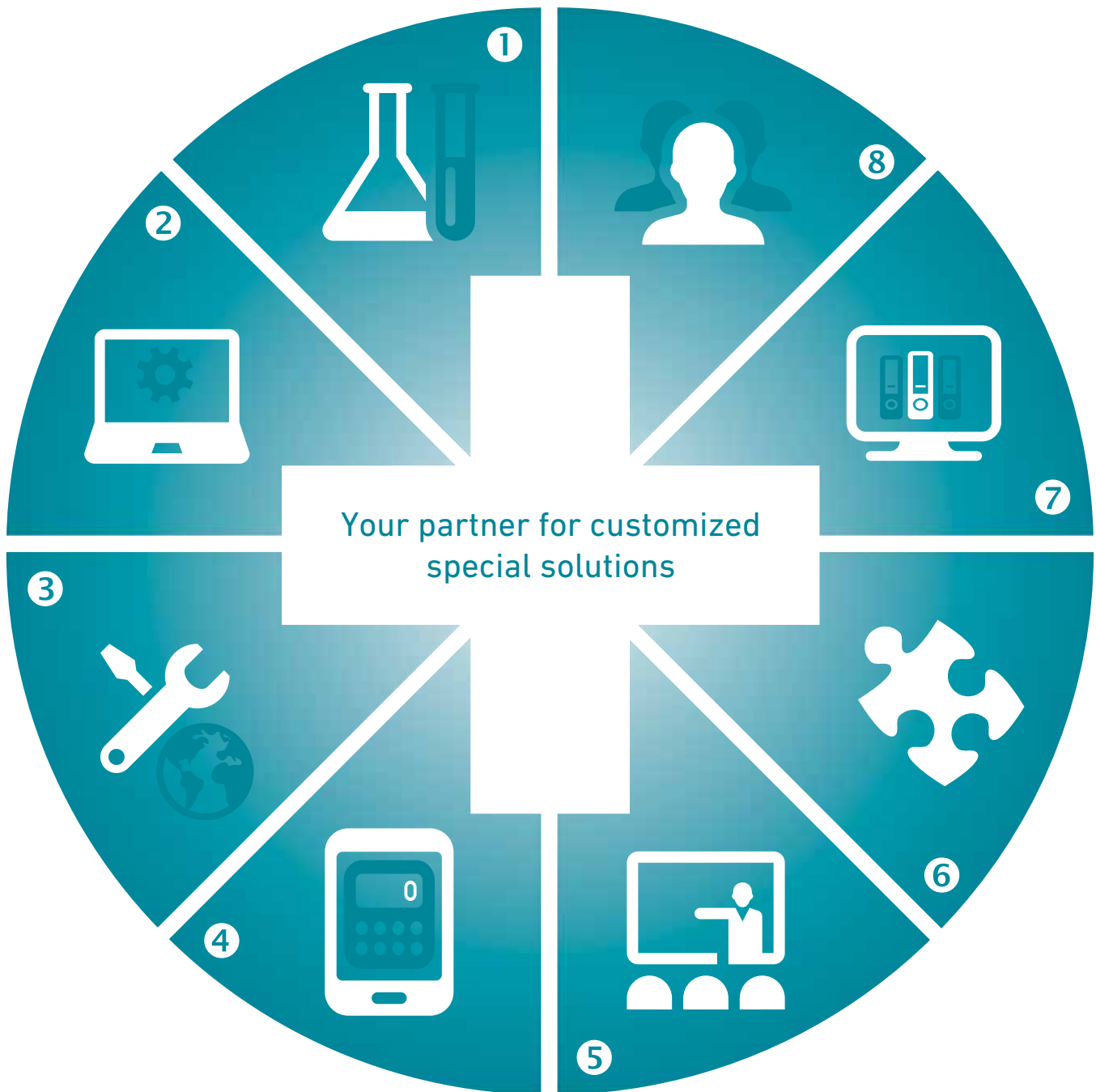

7 Technical manual

For our customers, we have documented the extensive know-how of GF Piping Systems in planning and installing plastic piping systems in our technical manual. This detailed documentation is available in both printed and digital version. The established reference book is helpful in planning large and small projects.

8 Training courses

GF Piping Systems offers a wide range of training courses that allow participants to gain confidence in working with our products and proven jointing technologies. The practical training is clearly defined, structured and adapted to the various levels of participants' experience.

Sustainability

GF Piping Systems incorporates its environmental responsibility into its everyday business activities. Because we understand environmental awareness as one of the corporation's core values, all internal structures and processes are geared towards sustainability. We strive to conserve natural resources and work continually towards optimizing the environmental performance of our products and how they are used. Consequently, outstanding material properties and innovative technologies form the basis for our environmentally friendly and energy-saving solutions.

Product Life Cycle

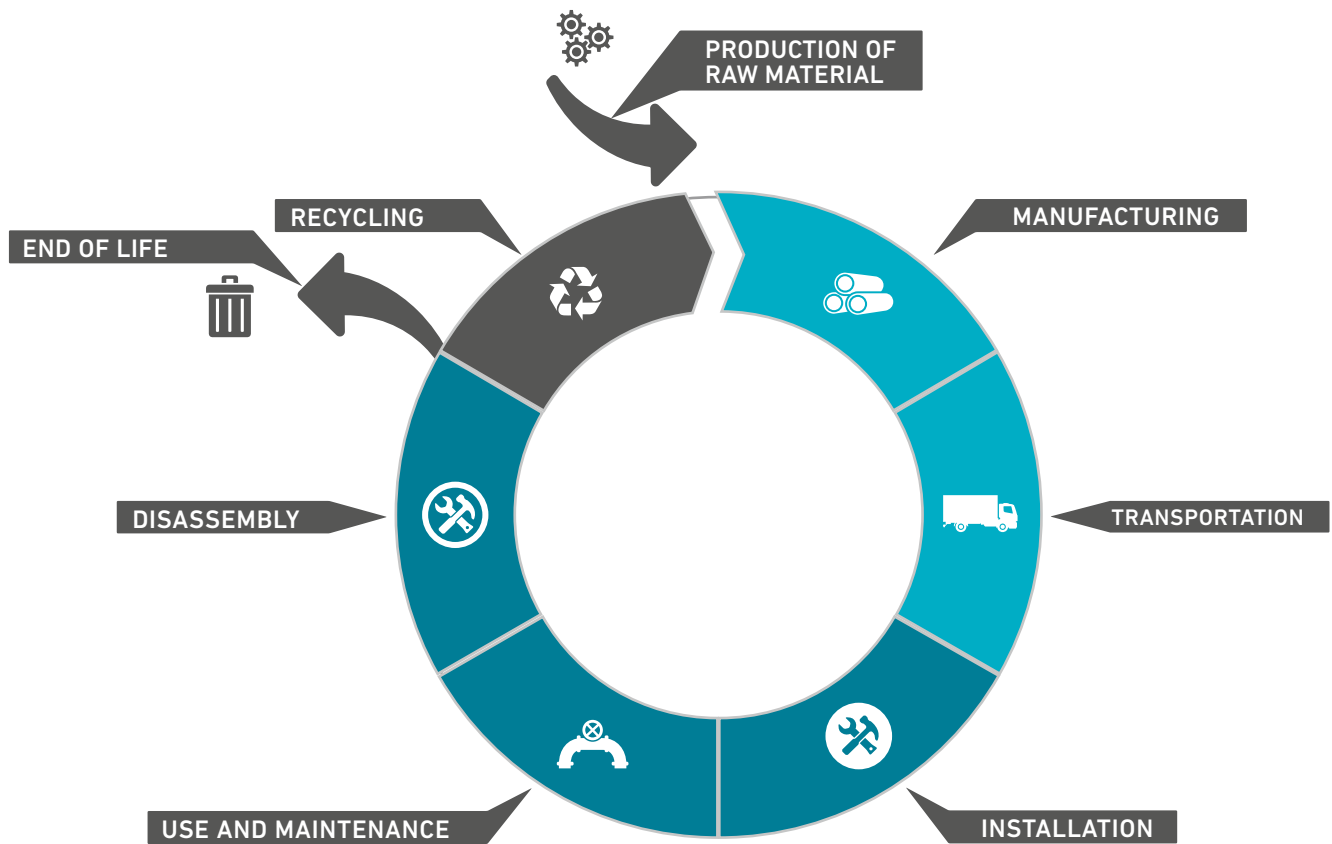

Life Cycle Assessments of GF specific industry systems

GF Piping Systems proactively performs life cycle assessments to determine the environmental impact of its products. In cooperation with an independent institute, life cycle assessments of selected GF Piping Systems were calculated. The life cycle assessments cover the environmental impact over the whole life cycle.

Reporting

GF began integrating sustainability requirements in its international operations early on by establishing a clearly defined organization and a system of internal reporting. The GF Corporation provides periodic reports on its performance in the area of sustainability. Environmental as well as social data are gathered annually via the Sustainability Information System. With this system, GF surveys its corporate subsidiaries to gather key indicator data in line with the Global Reporting Initiative (GRI). The guidelines of the Global Reporting Initiative lay down requirements for corporate sustainability reporting that are recognized throughout the world.

ELGEF Plus

Electrofusion system

- Polyethylene for utility applications



ELGEF Plus

System specification



*** Standards:**









	PE100
Material	
Color	RAL 9005
Density	~ 0.95 g/cm ³ (EN ISO 1183 / ASTM D 792)
Thermal expansion coefficient	0.15–0.20 mm/m K (DIN 53752)
Thermal conductivity at 23 °C	0.38 W/m K (EN 12664)
Thermal expansion	0.16–0.18 mm/m K
Yield stress at 23 °C	25 N/mm ² (EN ISO 527)
Tensile E-modul at 23 °C	900 N/mm ² (EN ISO 527)
Charpy notched impact strength at 23 °C	83 kJ/m ² (EN ISO 179)
Charpy notched impact strength at -40 °C	13 kJ/m ² (EN ISO 179)
Limiting Oxygen Index (LOI)	17.4 % (ISO 4589)
Dimensions	d20-d2000 in accordance to EN 1555-3 and EN 12201-1
Surface condition	in accordance to EN 1555-3 and EN 12201-1
Material and product approvals	<ul style="list-style-type: none"> - ACS (Attestation de Conformité Sanitaire) - BSI (BSI Assurance UK Limited) - NF (CERTIgaz) - DVGW (Deutscher Verein des Gas- und Wasserfaches) - FM Approvals - Global Mark - IIP (Istituto Italiano dei Plastici) - INSTA-CERT (Dancert S/A) - KIWA (Keuringsinstituut voor Waterleidingsartikelen) - KTW / W270 (Kunststoff-Trinkwasser-Empfehlungen) - SVGW (Schweizerischer Verein des Gas- und Wasserfaches)
Packaging	Fittings and valves are bagged
Marking and labeling	<p>All components are embossed with a permanent identification during the production process to ensure full traceability:</p> <ul style="list-style-type: none"> - Brand name - Material - Dimensions - Pressure rating - Lot No. - Product description - Article number - Standard and approvals

*** Approvals / Acceptance:**



* An overview of all standards and approvals is stated online: www.gfps.com

ELGEF Plus electrofusion fittings

ELGEF Plus electrofusion fittings		Page
	Couplers	17
	Elbows	20
	Tees	22
	Reducers	24
	End caps	26
	Transition fittings	27
	Accessories	32



Couplers

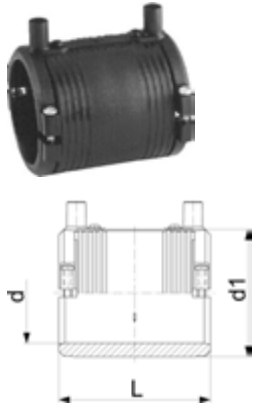

Coupler With integral pipe fixation

- PE 100 SDR 11 (ISO S5)
- 10 bar Gas / 16 bar Water
- 4 mm pin connectors
- Limited path fusion indicators
- Removable centre stop

d (mm)	Code	Weight (kg)	d1 (mm)	L (mm)	SDR pipe
20	753 911 606	0.053	31	70	9-11
25	753 911 607	0.050	36	70	9-11
32	753 911 608	0.071	44	72	9-11
40	753 911 609	0.095	54	80	9-11
50	753 911 610	0.131	66	88	9-11
63	753 911 611	0.194	81	96	9-17.6



Coupler

- PE 100 SDR 11 (ISO S5)
- 10 bar Gas / 16 bar Water
- 4 mm pin connectors
- Limited path fusion indicators
- Removable centre stop up to d160

d (mm)	Code	Weight (kg)	d1 (mm)	L (mm)	SDR pipe
75	753 911 612	0.282	96	110	9-17.6
90	753 911 613	0.406	113	125	9-17.6
110	753 911 614	0.692	138	145	9-17.6
125	753 911 615	0.718	154	156	9-17.6
140	753 911 616	0.945	172	166	9-17.6
160	753 911 617	1.362	196	180	9-17.6
180	753 911 618	1.747	219	192	9-17.6
200	753 911 619	1.866	244	208	9-17.6
225	753 911 620	3.329	273	225	9-17.6
250	753 911 621	4.678	304	248	9-17.6
280	753 911 622	7.500	340	252	9-17.6
315	753 911 623	8.142	382	267	9-17.6



Coupler

- PE 100 SDR 11 (ISO S5)
- 10 bar Gas / 16 bar Water
- 4 mm pin connectors
- Limited path fusion indicators
- With active reinforcement

d (mm)	Code	Weight (kg)	d1 (mm)	L (mm)	SDR pipe
355	753 911 704	13.098	438	291	9-17
400	753 911 705	18.320	493	295	9-17
450	753 911 706	24.700	554	327	9-17
500	753 911 707	33.700	616	358	9-17
560	753 911 708	46.200	689	396	9-17
630	753 911 709	65.300	775	440	9-17
710	753 911 710	87.400	874	463	9-17
800	753 911 711	114.500	982	484	9-17

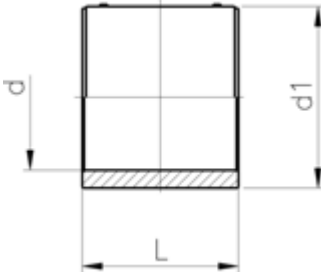

Coupler



- PE 100 SDR 11 (ISO S5)
- 16 bar Water
- Only for water applications
- 4 mm pin connectors

d (mm)	Code	Weight (kg)	d1 (mm)	L (mm)	SDR pipe
900	753 911 652	137.930	1110	550	9-17.6



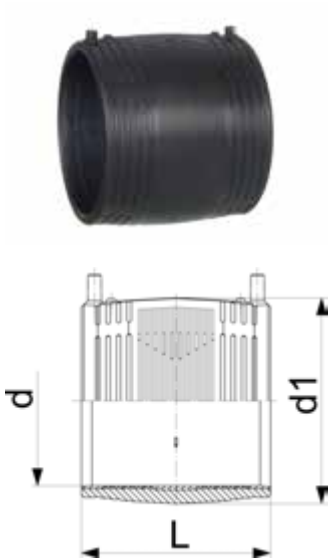

Coupler

- PE 100 SDR 17 (ISO S8)
- 5 bar Gas / 10 bar Water
- 4 mm pin connectors
- Limited path fusion indicators
- d160 with removable centre stop

d (mm)	Code	Weight (kg)	d1 (mm)	L (mm)	SDR pipe
160	753 911 817	1.017	186	180	9-26
180	753 911 818	1.434	213	192	9-26
200	753 911 819	1.726	233	206	9-26
225	753 911 820	2.545	261	225	9-26
250	753 911 821	4.616	304	248	9-26
280	753 911 822	5.606	340	252	9-26
315	753 911 823	6.100	382	267	9-26



Coupler

- PE 100 SDR 17 (ISO S8)
- 5 bar Gas / 10 bar Water
- 4 mm pin connectors
- Limited path fusion indicators
- With active reinforcement

d (mm)	Code	Weight (kg)	d1 (mm)	L (mm)	SDR pipe
355	753 911 804	9.522	416	291	17-33
400	753 911 805	18.000	467	295	17-33
450	753 911 806	16.000	526	327	17-33
500	753 911 807	22.000	584	358	17-33
560	753 911 808	34.000	647	396	17-33
630	753 911 809	46.000	727	440	17-33
710	753 911 810	55.600	820	463	17-33
800	753 911 811	73.000	922	484	17-33



Coupler

- PE 100 SDR 17 (ISO S8)
- 10 bar water
- Only for water applications
- 4 mm pin connectors

d (mm)	Code	Weight (kg)	d1 (mm)	L (mm)	SDR pipe
900	753 911 852	93.150	1030	550	9-26
1000	753 911 853	125.650	1143	600	9-26
1200	753 911 854	196.450	1370	650	9-26





Coupler

- PE 100 SDR 26 (ISO S12.5)
- 6 bar water
- Only for water applications
- 4 mm pin connectors

d (mm)	Code	Weight (kg)	d1 (mm)	L (mm)	SDR pipe
710	753 911 950	31.920	797	360	9-26
800	753 911 951	42.800	897	380	9-26
900	753 911 952	57.580	1009	400	9-26
1000	753 911 953	79.270	1121	440	9-26
1200	753 911 954	125.700	1345	480	9-26

Elbows



Elbow 90° With integral pipe fixation

- PE 100 SDR 11 (ISO S5)
- 10 bar Gas / 16 bar Water
- 4 mm pin connectors
- Limited path fusion indicators

d (mm)	Code	Weight (kg)	d1 (mm)	L (mm)	L1 (mm)	z (mm)	SDR pipe
20	753 101 606	0.080	35	54	34	20	9-11
25	753 101 607	0.074	35	54	34	20	9-11
32	753 101 608	0.094	44	53	36	17	9-11
40	753 101 609	0.128	54	62	39	23	9-11
50	753 101 610	0.196	66	71	43	28	9-11
63	753 101 611	0.312	81	81	48	32	9-17.6

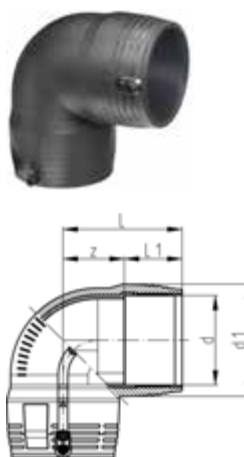

Elbow 90°

- PE 100 SDR 11 (ISO S5)
- 10 bar Gas / 16 bar Water
- 4 mm pin connectors
- Limited path fusion indicators

d (mm)	Code	Weight (kg)	d1 (mm)	L (mm)	L1 (mm)	z (mm)	SDR pipe
75	753 101 612	0.415	97	94	54	40	9-11
90	753 101 813	0.828	115	122	62	60	9-17.6
110	753 101 814	1.224	140	147	72	76	9-17.6
125	753 101 815	1.742	160	155	77	68	9-17.6
160	753 101 817	3.830	196	191	92	103	11-17.6
180	753 101 818	5.410	219	210	96	114	11-17.6

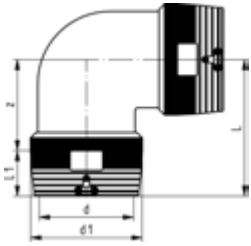

Elbow 90°

- PE 100 SDR 11 (ISO S5)
- 10 bar Gas / 16 bar Water
- 4 mm pin connectors
- Limited path fusion indicators
- Two separate fusion zones

d (mm)	Code	Weight (kg)	d1 (mm)	L (mm)	L1 (mm)	z (mm)	SDR pipe
200	753 101 819	9.320	250	298	104	194	11-26
225	753 101 820	13.220	280	318	112	206	11-26
250	753 101 821	16.600	310	347	123	224	11-26

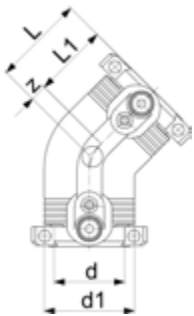

Elbow 45° With integral pipe fixation

- PE 100 SDR 11 (ISO S5)
- 10 bar Gas / 16 bar Water
- 4 mm pin connectors
- Limited path fusion indicators

d (mm)	Code	Weight (kg)	d1 (mm)	L (mm)	L1 (mm)	z (mm)	SDR pipe
32	753 151 608	0.075	44	44	36	8	9-11
40	753 151 609	0.106	54	50	39	11	9-11
50	753 151 610	0.171	66	56	43	13	9-11
63	753 151 611	0.252	81	63	48	15	9-17.6

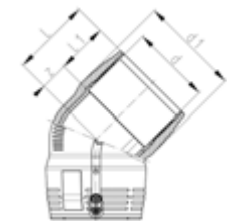

Elbow 45°

- PE 100 SDR 11 (ISO S5)
- 10 bar Gas / 16 bar Water
- 4 mm pin connectors
- Limited path fusion indicators

d (mm)	Code	Weight (kg)	d1 (mm)	L (mm)	L1 (mm)	z (mm)	SDR pipe
75	753 151 612	0.332	97	71	54	17	9-11
90	753 151 813	0.583	115	91	62	29	9-11
110	753 151 814	0.985	140	112	72	40	9-17.6
125	753 151 815	1.438	160	119	78	49	9-17.6
160	753 151 817	3.055	196	135	92	42	11-17.6
180	753 151 818	4.037	217	144	95	47	11-17.6



Elbow 45°

- PE 100 SDR 11 (ISO S5)
- 10 bar Gas / 16 bar Water
- 4 mm pin connectors
- Limited path fusion indicators
- Two separate fusion zones

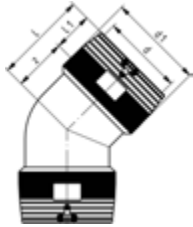

d (mm)	Code	Weight (kg)	d1 (mm)	L (mm)	L1 (mm)	z (mm)	SDR pipe
200	753 151 819	7.566	250	232	104	128	11-26
225	753 151 820	11.300	280	247	112	135	11-26
250	753 151 821	13.500	310	275	123	152	11-26

Tees



Tee 90° equal With integral pipe fixation

- PE 100 SDR 11 (ISO S5)
- 10 bar Gas / 16 bar Water
- 4 mm pin connectors
- Limited path fusion indicators

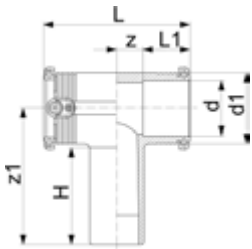

d (mm)	Code	Weight (kg)	d1 (mm)	L (mm)	L1 (mm)	z (mm)	z1 (mm)	H (mm)	SDR pipe
20	753 211 606	0.085	35	88	32	11	92	67	9-11
25	753 211 607	0.075	35	90	32	11	92	70	9-11
32	753 211 608	0.118	44	102	34	15	100	74	9-11
40	753 211 609	0.175	54	119	39	21	114	82	9-11
50	753 211 610	0.252	66	135	42	24	126	90	9-11
63	753 211 611	0.407	81	151	46	28	150	102	9-17.6



Tee 90° equal

- PE 100 SDR 11 (ISO S5)
- 10 bar Gas / 16 bar Water
- 4 mm pin connectors
- Limited path fusion indicators

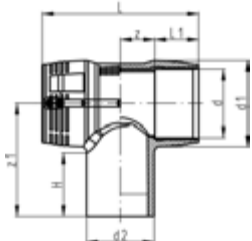

d (mm)	Code	Weight (kg)	d1 (mm)	L (mm)	L1 (mm)	z (mm)	z1 (mm)	H (mm)	SDR pipe
75	753 211 612	0.569	97	178	54	35	143	87	9-17.6
90	753 201 813	0.891	115	205	62	41	161	94	9-17.6
110	753 201 814	1.576	140	255	72	56	184	104	9-17.6
125	753 201 815	2.212	161	276	78	60	207	113	9-17.6
160	753 201 817	4.386	196	325	92	71	206	103	11-17.6
180	753 201 818	6.796	225	344	90	82	250	110	11-17.6



Tee 90° equal

- PE 100 SDR 11 (ISO S5)
- 10 bar Gas / 16 bar Water
- 4 mm pin connectors
- Limited path fusion indicators
- Two separate fusion zones

d (mm)	Code	Weight (kg)	d1 (mm)	L (mm)	L1 (mm)	z (mm)	z1 (mm)	H (mm)	SDR pipe
200	753 201 819	10.800	250	590	104	191	250	117	11-26
225	753 201 820	15.900	280	636	112	206	270	122	11-26
250	753 201 821	18.900	310	685	123	220	288	127	11-26

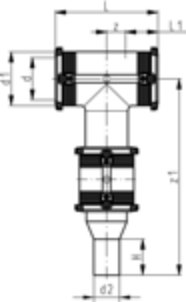

Tee 90° reduced (kit)

- PE 100 SDR 11 (ISO S5)
- 10 bar Gas / 16 bar Water
- Integral pipe fixation (up to d63)
- 4 mm pin connectors
- Limited path fusion indicators
- Supplied as kit including ELGEF Plus Coupler and Spigot Reducer

d (mm)	d2 (mm)	Code	Weight (kg)	d1 (mm)	L (mm)	L1 (mm)	z (mm)	z1 (mm)	H (mm)
40	20	193 281 004	0.314	54	120	39	21	244	41
40	25	193 281 005	0.319	54	120	39	21	244	41
75	40	193 280 998	1.060	97	187	61	33	296	49
90	50	193 280 999	1.655	112	202	61	41	336	55
110	63	193 280 961	2.812	136	242	65	56	336	63
125	63	193 280 963	3.673	151	256	75	53	361	63
125	110	193 280 965	3.920	151	256	75	53	389	82
180	90	193 281 032	10.891	225	344	90	82	487	79
180	110	193 281 033	10.465	225	344	90	82	495	82

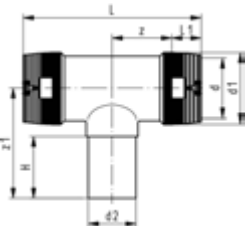

Tee 90° reduced

- PE 100 SDR 11 (ISO S5)
- 10 bar Gas / 16 bar Water
- 4 mm pin connectors
- Limited path fusion indicators
- Two separate fusion zones

d (mm)	d2 (mm)	Code	Weight (kg)	d1 (mm)	L (mm)	L1 (mm)	z (mm)	z1 (mm)	H (mm)	SDR pipe
110	90	753 211 034	1.652	140	255	72	56	245	80	9-17.6
125	90	753 211 035	2.242	156	276	75	53	245	80	9-17.6
160	63	753 211 037	5.660	200	493	90	127	174	65	11-17.6
160	90	753 211 039	5.508	200	492	90	158	190	79	11-17.6
160	110	753 211 040	5.157	200	491	90	158	200	85	11-17.6
200	90	753 211 059	9.012	250	595	104	194	216	81	11-26
200	110	753 211 060	12.400	250	600	104	194	219	84	11-26
200	160	753 211 063	12.400	250	595	104	194	237	101	11-26
225	90	753 211 069	13.100	280	666	112	217	228	80	11-26
225	110	753 211 070	13.100	280	670	112	217	238	85	11-26
225	160	753 211 073	13.600	280	667	112	217	258	105	11-26
250	110	753 211 080	11.660	310	709	123	220	284	85	11-26
250	160	753 211 083	17.070	310	711	123	220	266	101	11-26

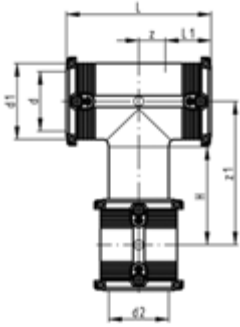

Tee 90° with weldable outlet (kit) Equal or reduced

- PE 100 SDR 11 (ISO S5)
- 10 bar Gas / 16 bar Water
- Integral pipe fixation (up to d63)
- 4 mm pin connectors
- Limited path fusion indicators
- Supplied as kit including ELGEF Plus Coupler or ELGEF Plus Reducer

d (mm)	d2 (mm)	Code	Weight (kg)	d1 (mm)	L (mm)	L1 (mm)	z (mm)	z1 (mm)	H (mm)
20	20	753 201 606	0.161	35	90	34	11	92	67
25	25	753 201 607	0.122	35	90	34	11	92	70
32	32	753 201 608	0.201	44	102	36	15	100	74
40	32	193 281 006	0.288	54	120	39	21	127	95
40	40	753 201 609	0.285	54	120	39	21	114	82
50	32	193 281 007	0.364	66	135	43	24	144	108
50	40	193 281 008	0.407	66	135	43	24	140	104
50	50	753 201 610	0.389	66	135	43	24	126	90
63	32	193 280 997	0.550	81	152	48	28	173	125
63	40	193 281 009	0.566	81	152	48	28	169	121
63	50	193 281 010	0.628	81	152	48	28	165	117
63	63	753 201 611	0.615	81	152	48	28	150	102
90	63	193 281 011	1.311	112	202	61	41	182	120
90	90	753 201 613	1.342	112	202	61	41	146	84
110	90	193 281 012	2.343	136	242	65	56	200	127
110	110	753 201 614	2.329	136	242	65	56	161	88
125	90	193 281 013	3.146	151	256	75	53	214	132
125	125	753 201 615	2.960	151	256	75	53	174	92
160	110	193 281 030	7.443	196	325	92	71	271	168
160	160	753 201 617	6.359	196	325	92	71	206	103
180	125	193 281 031	9.654	225	344	90	82	330	190
180	180	753 201 618	8.561	225	344	90	82	250	110

Reducers

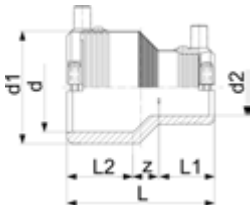

Reducer With integral pipe fixation

- PE 100 SDR 11 (ISO S5)
- 10 bar Gas / 16 bar Water
- 4 mm pin connectors
- Limited path fusion indicators

d (mm)	d2 (mm)	Code	Weight (kg)	d1 (mm)	L (mm)	L1 (mm)	L2 (mm)	z (mm)	SDR pipe
25	20	753 901 639	0.051	35	74	34	34	6	9-11
32	20	753 901 640	0.056	44	79	33	36	10	9-11
32	25	753 901 641	0.062	44	79	33	36	10	9-11
40	20	753 901 644	0.069	54	88	33	39	15	9-11
40	25	753 901 645	0.084	54	88	33	39	15	9-11
40	32	753 901 646	0.095	54	88	33	39	13	9-11
50	32	753 901 651	0.124	66	96	35	43	18	9-11
50	40	753 901 652	0.119	66	96	39	43	14	9-11
63	32	753 901 656	0.158	81	105	35	48	23	9-11
63	40	753 901 657	0.176	81	105	39	48	19	9-11
63	50	753 901 658	0.176	81	105	43	48	15	9-11

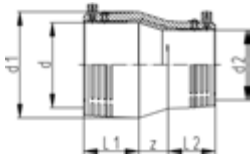

Reducer

- PE 100 SDR 11 (ISO S5)
- 10 bar Gas / 16 bar Water
- 4 mm pin connectors
- Limited path fusion indicators

d (mm)	d2 (mm)	Code	Weight (kg)	d1 (mm)	L (mm)	L1 (mm)	L2 (mm)	z (mm)	SDR pipe
90	63	753 901 831	0.385	113	146	63	47	36	9-17.6
110	63	753 901 832	0.644	140	184	71	58	55	9-11
110	90	753 901 833	0.700	138	173	73	63	38	9-17.6
125	90	753 901 836	0.891	152	180	79	61	40	9-17.6
160	90	753 901 839	1.600	202	227	90	72	65	9-17.6
160	110	753 901 864	1.783	202	226	90	71	65	9-17.6
180	125	753 901 865	2.340	225	254	96	78	80	9-17.6

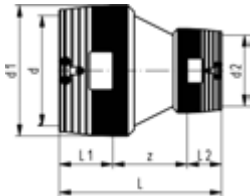

Reducer

- PE 100 SDR 11 (ISO S5)
- 10 bar Gas / 16 bar Water
- 4 mm pin connectors
- Limited path fusion indicators
- Two separate fusion zones

d (mm)	d2 (mm)	Code	Weight (kg)	d1 (mm)	L (mm)	L1 (mm)	L2 (mm)	z (mm)	SDR pipe
200	160	753 901 837	5.098	250	365	104	90	171	11-26
225	160	753 901 838	6.000	280	385	112	90	183	11-26
225	200	753 901 845	8.200	280	390	112	104	173	11-26
250	160	753 901 840	7.860	310	400	123	90	187	11-26
250	200	753 901 841	8.480	310	417	123	104	200	11-26
250	225	753 901 842	8.450	310	430	123	112	204	11-26

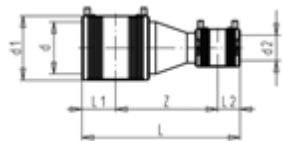

Reducer (kit)

- PE 100 SDR 11 (ISO S5)
- 10 bar Gas / 16 bar Water
- Integral pipe fixation (up to d63)
- 4 mm pin connectors
- Limited path fusion indicators
- Supplied as kit including ELGEF Plus Coupler and Spigot Reducer

d (mm)	d2 (mm)	Code	Weight (kg)	d1 (mm)	L (mm)	L1 (mm)	L2 (mm)	z (mm)
75	40	193 280 992	0.574	96	265	55	40	170
75	50	193 280 993	0.623	96	269	55	44	170
75	63	193 280 994	0.700	96	273	55	48	170
90	50	193 280 958	0.857	113	297	63	44	190
90	75	193 280 995	1.071	113	308	63	55	190
110	75	193 280 996	1.496	138	333	73	55	205
125	63	193 280 953	1.567	154	314	79	48	187
125	110	193 280 951	2.098	154	367	79	73	215
160	125	193 280 952	3.252	196	414	90	79	245
180	110	193 280 959	4.167	214	413	95	73	245

End caps

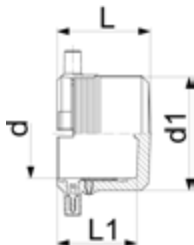

End cap With integral pipe fixation

- PE 100 SDR 11 (ISO S5)
- 10 bar Gas / 16 bar Water
- 4 mm pin connectors
- Limited path fusion indicators

d (mm)	Code	Weight (kg)	d1 (mm)	L (mm)	L1 (mm)	SDR pipe
20	753 961 606	0.041	35	52	44	9-11
25	753 961 607	0.046	35	52	44	9-11
32	753 961 608	0.058	44	52	44	9-11
40	753 961 609	0.064	54	56	47	9-11
50	753 961 610	0.154	66	60	49	9-11
63	753 961 611	0.142	81	66	54	9-17.6

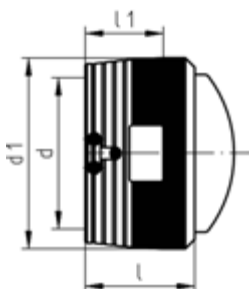

End cap

- PE 100 SDR 11 (ISO S5)
- 10 bar Gas / 16 bar Water
- 4 mm pin connectors
- Limited path fusion indicators

d (mm)	Code	Weight (kg)	d1 (mm)	L (mm)	L1 (mm)	SDR pipe
160	753 961 617	1.782	200	143	90	11-17.6
200	753 961 619	3.585	250	162	104	11-26
225	753 961 620	4.500	280	170	112	11-26
250	753 961 621	6.300	310	185	123	11-26

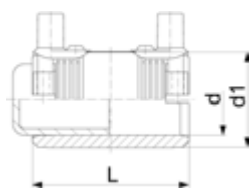

End cap (kit)

- PE 100 SDR 11 (ISO S5)
- 10 bar Gas / 16 bar Water
- 4 mm pin connectors
- Limited path fusion indicators
- Supplied as kit including ELGEF Plus Coupler

d (mm)	Code	Weight (kg)	d1 (mm)	L (mm)
75	753 961 712	0.446	96	110
90	753 961 713	0.663	113	125
110	753 961 714	1.090	133	145
125	753 961 715	1.345	155	158
140	753 961 716	2.250	175	170
160	753 961 717	2.382	197	180
180	753 961 718	3.098	220	194
200	753 961 719	4.180	245	208
225	753 961 720	5.852	296	224

Transition fittings

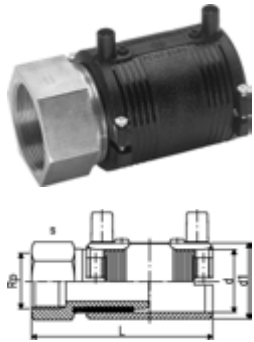

Transition coupler PE/steel (stainless 1.4305) Female thread

- PE 100 SDR 11 (ISO S5)
- 10 bar Gas / 16 bar Water
- With integral pipe fixation
- 4 mm pin connectors
- Limited path fusion indicators
- Supplied as a kit

d (mm)	Rp (inch)	Code	Weight (kg)	d1 (mm)	L (mm)	s (mm)	SDR pipe
20	¾	724 920 256	0.179	31	100	30	9-11
25	¾	724 920 257	0.231	36	101	35	9-11
32	1	724 920 258	0.319	44	108	40	9-11
40	1 ¼	724 920 259	0.480	54	118	50	9-11
50	1 ½	724 920 260	0.646	66	126	60	9-11
63	2	724 920 261	0.931	81	138	70	9-17.6

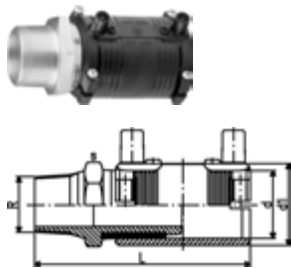

Transition coupler PE/steel (stainless 1.4305) Male thread

- PE 100 SDR 11 (ISO S5)
- 10 bar Gas / 16 bar Water
- With integral pipe fixation
- 4 mm pin connectors
- Limited path fusion indicators
- Delivered as a kit. Further combinations: modular system with threaded adapter and (150 228-1) reductions

d (mm)	R (inch)	Code	Weight (kg)	d1 (mm)	L (mm)	s (mm)	SDR pipe
20	¾	724 920 756	0.165	31	110	30	9-11
25	¾	724 920 757	0.249	36	111	35	9-11
32	1	724 920 758	0.332	44	117	40	9-11
40	1 ¼	724 920 759	0.464	54	127	50	9-11
40	1 ½	724 920 772	0.528	66	143	60	9-11
50	1 ½	724 920 760	0.611	66	135	60	9-11
63	1 ½	724 920 771	0.904	81	147	70	9-17.6
63	2	724 920 761	0.942	81	147	70	9-17.6



Transition coupler PE/brass (CW617N) With loose nut

- PE 100 SDR 11 (ISO S5)
- 16 bar Water
- With integral pipe fixation
- 4 mm pin connectors
- Limited path fusion indicators
- Delivered as a kit. Further combinations: modular system with threaded adapter and (150 228-1) reductions
- Incl. flat gasket for water applications (KTW / WRAS approved)

d (mm)	G (inch)	Code	Weight (kg)	d1 (mm)	d2 (mm)	L (mm)	SDR pipe
25	¾	720 910 007	0.232	36	15	104	9-11
32	1	720 910 008	0.297	44	20	110	9-11
32	1 ½	720 910 028	0.480	44	22	114	9-11
50	1 ½	720 910 010	0.736	66	29	133	9-11
63	1	720 910 021	1.013	81	20	137	9-17.6
63	2	720 910 011	1.251	81	36	145	9-17.6

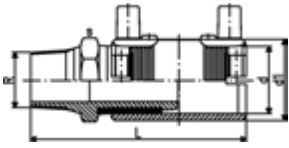

Transition coupler PE/brass (CW617N)
Male thread

- PE 100 SDR 11 (ISO S5)
- 10 bar Gas / 16 bar Water
- With integral pipe fixation
- 4 mm pin connectors
- Limited path fusion indicators
- Supplied as a kit with ELGEF Plus coupler or *reducer

	R (inch)	d (mm)	Code	Weight (kg)	d1 (mm)	L (mm)	s (mm)	SDR pipe
	½	20	720 920 756	0.187	31	110	30	9-11
*	1	20	720 920 754	0.344	44	124	40	9-11
	¾	25	720 920 757	0.254	36	111	35	9-11
*	1	25	720 920 763	0.340	44	124	40	9-11
*	½	32	720 920 764	0.213	44	121	30	9-11
	¾	32	720 920 765	0.268	44	122	35	9-11
	1	32	720 920 758	0.340	44	117	40	9-11
	1 ¼	32	720 920 766	0.489	54	135	50	9-11
	1 ½	32	720 920 767	0.635	60	143	60	9-11
*	2	32	720 920 768	1.000	81	157	70	9-11
	1	40	720 920 771	0.364	54	133	40	9-11
	1 ¼	40	720 920 759	0.514	54	127	50	9-11
	1 ½	40	720 920 772	0.645	66	143	60	9-11
*	2	40	720 920 773	0.961	81	157	70	9-11
	1	50	720 920 776	0.367	66	141	40	9-11
	1 ¼	50	720 920 777	0.554	66	143	50	9-11
	1 ½	50	720 920 760	0.652	66	135	60	9-11
	2	50	720 920 778	0.971	81	157	70	9-11
	1	63	720 920 781	0.441	81	151	40	9-11
	1 ¼	63	720 920 782	0.600	81	153	40	9-11
	1 ½	63	720 920 783	0.712	81	153	60	9-17.6
	2	63	720 920 761	0.943	81	147	70	9-17.6

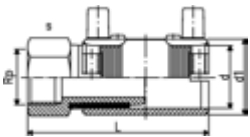

Transition coupler PE/brass (CW617N)
Female thread

- PE 100 SDR 11 (ISO S5)
- 10 bar Gas / 16 bar Water
- With integral pipe fixation
- 4 mm pin connectors
- Limited path fusion indicators
- Supplied as a kit

d (mm)	Rp (inch)	Code	Weight (kg)	d1 (mm)	L (mm)	s (mm)
32	1	720 920 258	0.306	44	108	40
40	1 ¼	720 920 259	0.496	54	118	50
50	1 ½	720 920 260	0.725	66	126	60
63	1	720 920 281	1.300	81	138	70
63	1 ¼	720 920 282	1.230	81	138	70
63	1 ½	720 920 283	1.134	81	138	70
63	2	720 920 261	1.057	81	138	70

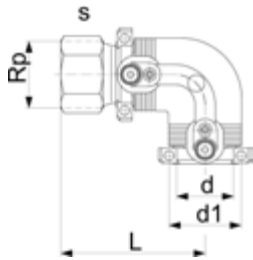

**Transition elbow 90° PE/steel (stainless 1.4305)
Female thread**

- PE 100 SDR 11 (ISO S5)
- 10 bar Gas / 16 bar Water
- With integral pipe fixation
- 4 mm pin connectors
- Limited path fusion indicators
- Supplied as a kit

d (mm)	Rp (inch)	Code	Weight (kg)	d1 (mm)	L (mm)	s (mm)	SDR pipe
20	½	724 100 256	0.211	31	86	30	9-11
25	¾	724 100 257	0.237	36	87	35	9-11
32	1	724 100 258	0.320	44	89	40	9-11
40	1 ¼	724 100 259	0.545	54	100	50	9-11
50	1 ½	724 100 260	0.805	66	109	60	9-11
63	2	724 100 261	1.020	81	123	70	9-17.6

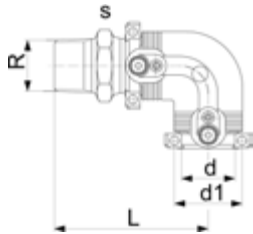

**Transition elbow 90° PE/steel (stainless 1.4305)
Male thread**

- PE 100 SDR 11 (ISO S5)
- 10 bar Gas / 16 bar Water
- With integral pipe fixation
- 4 mm pin connectors
- Limited path fusion indicators
- Supplied as a kit

d (mm)	R (inch)	Code	Weight (kg)	d1 (mm)	L (mm)	s (mm)	SDR pipe
20	½	724 100 756	0.211	31	96	30	9-11
25	¾	724 100 757	0.230	36	97	35	9-11
32	1	724 100 758	0.324	44	98	40	9-11
40	1 ¼	724 100 759	0.560	54	109	50	9-11
40	1 ½	724 100 772	0.599	54	109	60	9-11
50	1 ½	724 100 760	0.701	66	118	60	9-11
63	1 ½	724 100 771	0.986	81	132	70	9-17.6
63	2	724 100 761	1.105	81	132	70	9-17.6

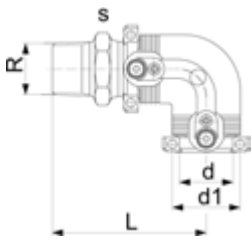

Transition elbow 90° PE/brass (CW617N)
Male thread

- PE 100 SDR 11 (ISO S5)
- 10 bar Gas / 16 bar Water
- With integral pipe fixation
- 4 mm pin connectors
- Limited path fusion indicators
- Supplied as a kit

d (mm)	R (inch)	Code	Weight (kg)	d1 (mm)	L (mm)	s (mm)	SDR pipe
20	½	720 100 756	0.240	31	96	30	9-11
25	¾	720 100 757	0.260	36	97	35	9-11
32	1	720 100 758	0.368	44	98	40	9-11
32	1 ¼	720 100 766	0.500	44	100	50	9-11
32	1 ½	720 100 767	0.562	44	100	60	9-11
40	1	720 100 771	0.511	54	107	50	9-11
40	1 ¼	720 100 759	0.534	54	109	50	9-11
40	1 ½	720 100 772	0.615	54	109	60	9-11
50	1	720 100 776	0.677	66	116	60	9-11
50	1 ¼	720 100 777	0.771	66	118	60	9-11
50	1 ½	720 100 760	0.734	66	118	60	9-11
63	1 ¼	720 100 782	1.040	81	128	70	9-17.6
63	1 ½	720 100 783	1.039	81	128	70	9-17.6
63	2	720 100 761	1.108	81	132	70	9-17.6

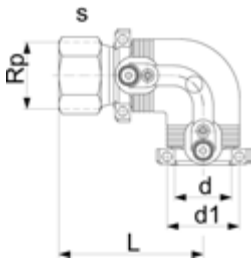

Transition elbow 90° PE/brass (CW617N)
Female thread

- PE 100 SDR 11 (ISO S5)
- 10 bar Gas / 16 bar Water
- With integral pipe fixation
- 4 mm pin connectors
- Limited path fusion indicators
- Supplied as a kit

d (mm)	Rp (inch)	Code	Weight (kg)	d1 (mm)	L (mm)	s (mm)	SDR pipe
32	1	720 100 258	0.359	44	89	40	9-11
40	1 ¼	720 100 259	0.525	54	100	50	9-11
50	1 ½	720 100 260	0.825	66	109	60	9-11
63	1	720 100 281	1.420	81	123	70	9-11
63	1 ¼	720 100 282	1.391	81	123	70	9-17.6
63	1 ½	720 100 283	1.305	81	123	70	9-17.6
63	2	720 100 261	1.165	81	123	70	9-17.6

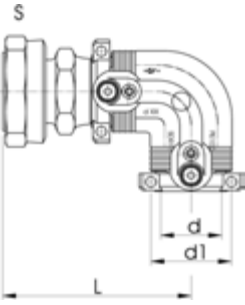

Transition elbow 90° PE/brass (CW617N) With loose nut

- PE 100 SDR 11 (ISO S5)
- 16 bar Water
- With integral pipe fixation
- 4 mm pin connectors
- Limited path fusion indicators
- Supplied as a kit
- Incl. flat gasket for water applications (KTW / WRAS approved)

d (mm)	Rp (inch)	Code	Weight (kg)	d1 (mm)	L (mm)	SDR pipe
25	¾	720 100 007	0.240	36	90	9-11
32	1	720 100 008	0.347	44	91	9-11
32	1 ¼	720 100 018	0.490	44	95	9-11
50	1 ½	720 100 010	0.850	66	116	9-11
63	1	720 100 021	1.114	81	121	9-17.6
63	2	720 100 011	1.375	81	129	9-17.6



Transition fittings PE/steel

- PE 100 SDR 11 (ISO S5)
- 10 bar Gas / 16 bar Water
- Electrofusion weldable
- PE coated for corrosion resistance
- * Steel pipe galvanized

	d (mm)	d1 (inch)	Code	Weight (kg)	L (mm)	L1 (mm)	L2 (mm)
*	20	½	775 641 502	0.450	425	15	80
	25	¾	775 641 507	0.658	463	35	90
	32	1	775 641 510	0.988	460	35	96
	40	1 ¼	775 641 514	1.208	470	35	100
	50	1 ½	775 641 518	1.355	480	35	110
	63	2	775 641 524	2.011	480	35	110
	75	2 ½	775 641 632	2.983	540	35	127
	90	3	775 641 636	3.762	580	45	141
	110	3	775 641 640	4.381	580	45	145
	110	4	775 641 641	6.633	585	45	145
	125	4	775 641 645	6.833	585	45	148
	160	6	775 641 655	12.406	610	45	158
	180	6	775 641 659	11.935	610	45	168
	200	8	775 642 664	19.647	630	45	155
	225	8	775 642 669	20.154	607	45	145
	250	8	775 642 665	21.354	630	45	200
	250	10	775 642 666	30.000	640	45	140
	280	10	775 642 673	31.000	640	45	160
	315	12	775 642 672	35.000	725	45	220
	355	12	775 642 675	49.000	735	45	260
	400	16	775 642 678	94.000	770	45	190

Accessories



Tangit KS Cleaner

- Special cleaner for plastic fusion connections in the material of PP, PE, PVDF and PB
- Suitable for Tangit Rapid. Must not be used for solvent cementing
- DVGW approved
- DW 5290 BR 0464

Size	Code	Weight (kg)
1 liter	799 298 023	0.872



Degreasing Tissues

- For degreasing the PE pipe surface prior to fusion





description	Type	Code	Weight (kg)
For pipes up to d225 mm	large	799 496 011	0.008



Marker

Type	Code	Weight (kg)
silver	799 350 364	0.010

ELGEF Plus electrofusion saddles

ELGEF Plus electrofusion saddles		Page
	Modular system	34
	Tapping saddles	39
	Pressure tapping valves	49
	Various parts	53
	Accessories & tools	57



Modular system

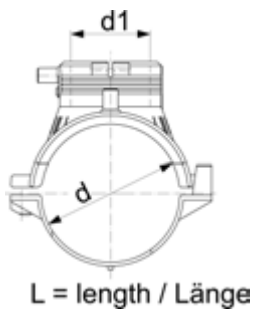

Electrofusion saddle

- PE 100 SDR 11 (ISO S5)
 - 10 bar Gas / 16 bar Water
 - Complete with lower part
 - 4 mm pin connectors
 - Limited path fusion indicators
 - In combination with parts of the modular System, the SDR compatibility is defined by the tapping-tees, tapping-valves and spigots with cutter.
- Topload: delivery without lower part for assembling as Top Load with tool no. 799.350.477
 * Complete with moulded-on lower part

	d (mm)	d1 (mm)	Code	Weight (kg)	L (mm)	SDR pipe
	63	63	193 131 037	0.325	165	9 - 11
	75	63	193 131 047	0.455	165	9 - 11
	90	63	193 131 057	0.415	165	9 - 17.6
	110	63	193 131 067	0.458	165	9 - 17.6
*	110	63	193 133 067	0.490	182	9 - 17.6
	125	63	193 131 077	0.502	165	9 - 17.6
	140	63	193 131 087	0.523	165	9 - 17.6
	160	63	193 131 097	0.493	165	9 - 17.6
*	160	63	193 133 097	0.543	182	9 - 17.6
	180	63	193 131 107	0.600	165	9 - 26
	200	63	193 131 117	0.634	165	9 - 26
	225	63	193 131 127	0.618	165	9 - 26
	250	63	193 131 137	0.627	165	9 - 26
Topload	280	63	193 131 147	0.359	165	9 - 26
Topload	315 - 355	63	193 131 157	0.373	165	9 - 33
Topload	400	63	193 131 177	0.356	165	9 - 33

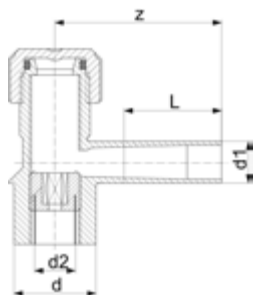

Tapping tee

- PE 100 SDR 11 (ISO S5)
 - 10 bar Gas / 16 bar Water
 - With integrated cutter to tap live mains under pressure
 - Long fusion outlet
 - O-ring-sealed screw cap
 - For ELGEF Plus Branch Saddle d63-225mm, pipe SDR 11
 - For ELGEF Plus Branch Saddle d90-315mm, pipe SDR 17
- * For ELGEF Plus Branch Saddle d250-315mm, pipe SDR 11 and d250-400mm, pipe SDR 17
 ** For ELGEF Plus Branch Saddle d110 - 225mm, pipe SDR11 and d110 - 315mm, pipe SDR17

	d (mm)	d1 (mm)	Code	Weight (kg)	d2 (mm)	L (mm)	z (mm)	SW (mm)
	63	20	193 280 358	0.380	32	69	130	17
	63	25	193 280 359	0.375	32	70	130	17
	63	32	193 280 184	0.232	32	76	130	17
	63	40	193 280 360	0.396	32	81	137	17
	63	63	193 280 185	0.687	35	100	160	17
*	63	63	193 280 711	1.120	35	100	160	17
**	63	63	193 280 290	1.086	41	100	160	17

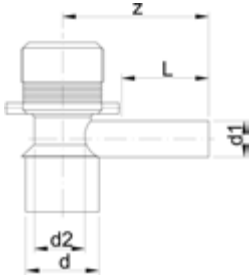

Tapping tee With electrofusion cap

- PE 100 SDR 11 (ISO S5)
- 10 bar Gas / 16 bar Water
- With integrated cutter to tap live mains under pressure
- For ELGEF Plus Branch Saddle d63-225mm, pipe SDR 11
- For ELGEF Plus Branch Saddle d90-315mm, pipe SDR 17
- Long fusion outlet

d (mm)	d1 (mm)	Code	Weight (kg)	d2 (mm)	D2 (mm)	L (mm)	z (mm)	SW (mm)
63	32	193 280 300	0.441	32	32	76	130	17
63	63	193 280 301	1.209	32	32	100	160	17

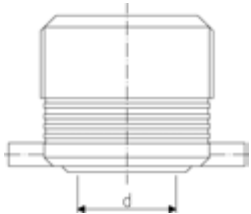

Electrofusion cap

- PE 100 SDR 11 (ISO S5)
- 10 bar Gas / 16 bar Water
- For ELGEF Plus Tapping Saddles
- 193 280 153 is suitable for all Tapping Tees with outlets d20, d25, d32, d40 mm
- 193 280 154 is suitable for all Tapping Tees with d63 mm outlet

d (mm)	Code	Weight (kg)
55	193 280 153	0.126
68	193 280 154	0.200

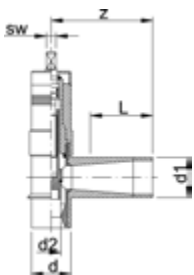

Tapping valve tee

- PE 100 SDR 11 (ISO S5)
- 10 bar Gas / 16 bar Water
- With integrated cutter to tap live mains under pressure
- For ELGEF Plus Branch Saddle d63 - 250, pipe SDR11
- For ELGEF Plus Branch Saddle d75 - 315mm, pipe SDR 17 and d250 - 400mm, pipe SDR 26
- Spindle size (SW) 14
- Number of turns to fully open or close valve is 13 for outlet d32
- Number of turns to fully open or close valve is 28 for outlet d63
- Long fusion outlet

d (mm)	d1 (mm)	Code	Weight (kg)	d2 (mm)	L (mm)	z (mm)
63	32	193 281 605	1.493	21	70	127
63	63	193 281 606	2.361	31	100	160

Stop-off adaptor with brass plug



- PE 100 SDR 11 (ISO S5)
- 10 bar Gas / 16 bar Water
- For ELGEF Plus Branch Saddle d63 - 400mm, pipe SDR 11
- For main dimension d63 and d75mm we recommend a maximum cutting diameter of d = 39mm
- Stop-Off insert (CW617N) and plug

d	Rp	Code	Weight	d1	L	z	SW
(mm)	(inch)		(kg)	(mm)	(mm)	(mm)	(mm)
63	2 1/2	193 280 294	1.375	56.5	93	46	19

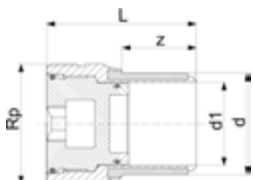

Stop-off adaptor PE



- PE 100 SDR 11 (ISO S5)
- 10 bar Gas / 16 bar Water
- For ELGEF Plus Branch Saddle d63 - 400mm, pipe SDR 11, d75 - 400mm, pipe SDR 17
- PE Stop-Off insert d 63
- Plug with rubber seal
- PVP nut
- For main dimension d63 and d75mm we recommend a maximum cutting diameter of d = 39mm

d	G	Code	Weight	d1	L	z
(mm)	(inch)		(kg)	(mm)	(mm)	(mm)
63	2 3/4	193 280 279	0.254	51	87	45

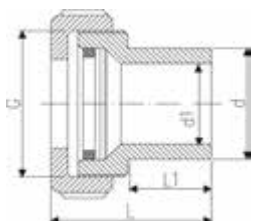

Spigot with cutter



- PE 100 SDR 11 (ISO S5)
- 10 bar Gas / 16 bar Water
- For ELGEF Plus Branch Saddle d63-225mm, pipe SDR 11
- For ELGEF Plus Branch Saddle d75 - 315mm, pipe SDR 17 and d250 - 400mm, pipe SDR 26

d	d1	Code	Weight	d2	L	L1	SW
(mm)	(mm)		(kg)	(mm)	(mm)	(mm)	(mm)
63	32	193 280 272	0.144	19	113	50	13
63	63	193 280 273	0.692	32	120	50	17

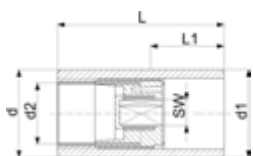



Transition adaptor PE/brass (CW617N) Male thread

- PE 100 SDR 11 (ISO S5)
- 10 bar Gas / 16 bar Water
- Only for ELGEF Plus Couplers and Fittings

d (mm)	R (inch)	Code	Weight (kg)	L (mm)	z (mm)
20	½	720 920 706	0.133	75	33
25	¾	720 920 707	0.182	76	33
32	1	720 920 708	0.257	80	35
32	1 ¼	720 920 718	0.370	82	35
32	1 ½	720 920 728	0.437	82	35
40	1	720 920 719	0.358	84	39
40	1 ¼	720 920 709	0.405	86	39
40	1 ½	720 920 729	0.454	86	39
50	1	720 920 720	0.505	88	43
50	1 ¼	720 920 730	0.539	90	43
50	1 ½	720 920 710	0.514	90	43
63	1 ¼	720 920 721	0.739	94	47
63	1 ½	720 920 731	0.709	94	47
63	2	720 920 711	0.762	98	47

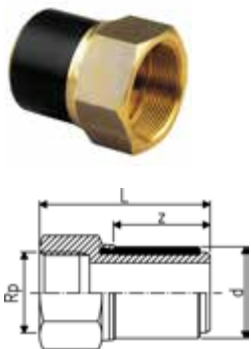

Transition adaptor PE/brass (CW617N) Female thread

- PE 100 SDR 11 (ISO S5)
- 10 bar Gas / 16 bar Water
- Only for ELGEF Plus Couplers and Fittings

d (mm)	Rp (inch)	Code	Weight (kg)	L (mm)	z (mm)
32	1	720 920 208	0.250	71	35
40	1 ¼	720 920 209	0.386	77	39
50	1 ½	720 920 210	0.520	81	43
63	1	720 920 221	0.780	89	47
63	1 ¼	720 920 231	1.062	89	47
63	1 ½	720 920 241	0.740	89	47
63	2	720 920 211	0.729	89	47

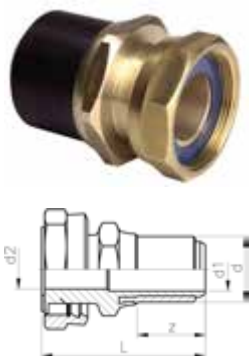

Transition adaptor PE/brass Loose nut (CW617N)

- PE 100 SDR 11 (ISO S5)
- 16 bar Water
- Only for ELGEF Plus Couplers and Fittings
- Incl. flat gasket for water applications (KTW / WRAS approved)

d (mm)	G (inch)	Code	Weight (kg)	d2 (mm)	L (mm)	z (mm)
25	¾	720 920 007	0.152	15	68	32
32	1	720 920 008	0.235	20	72	34
32	1 ¼	720 920 018	0.356	22	76	34
50	1 ½	720 920 010	0.584	29	87	42
63	1	720 920 021	0.804	20	87	46
63	2	720 920 011	1.018	36	95	46

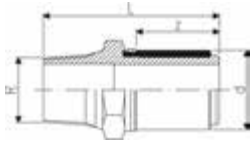

**Transition adaptor PE/steel (stainless 1.4305)
Male thread**

- PE 100 SDR 11 (ISO S5)
- 10 bar Gas / 16 bar Water
- Only for ELGEF Plus Couplers and Fittings

d (mm)	R (inch)	Code	Weight (kg)	L (mm)	z (mm)
20	½	724 920 706	0.120	75	33
25	¾	724 920 707	0.179	76	33
32	1	724 920 708	0.244	80	35
40	1 ¼	724 920 709	0.380	86	39
40	1 ½	724 920 719	0.446	86	39
50	1 ½	724 920 710	0.478	90	43
63	1 ½	724 920 721	0.653	98	47
63	2	724 920 711	0.722	98	47

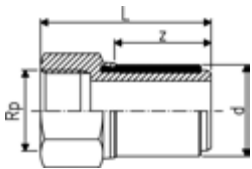

**Transition adaptor PE/steel (stainless 1.4305)
Female thread**

- PE 100 SDR 11 (ISO S5)
- 10 bar Gas / 16 bar Water
- Only for ELGEF Plus Couplers and Fittings

d (mm)	Rp (inch)	Code	Weight (kg)	L (mm)	z (mm)
20	½	724 920 206	0.128	65	33
25	¾	724 920 207	0.181	66	33
32	1	724 920 208	0.237	71	35
40	1 ¼	724 920 209	0.373	77	39
50	1 ½	724 920 210	0.527	81	43
63	2	724 920 211	0.733	89	47

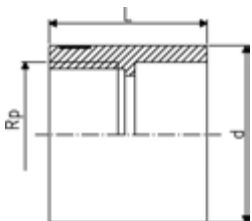

**PE adaptor
Female thread**

- PE 80 SDR 11 (ISO S5)
- 5 bar Gas / 12,5 bar Water
- Connection to plastic or metal
- Reinforcing ring stainless (A2)
- For ELGEF Plus Branch Saddle d63 - 400mm, pipe SDR 11, d75 - 400mm, pipe SDR 17
- Parallel female thread
- * PE 100 SDR 11 (ISO S5)
- * 5 bar Gas/ 16 bar water

d (mm)	Rp (inch)	Code	Weight (kg)	L (mm)
*	63 ½	193 281 617	0.060	68
	63 1 ½	173 281 925	0.088	54

Tapping saddles

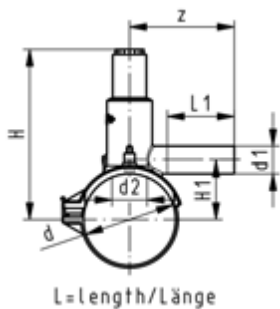

Tapping saddle Monobloc version

- PE 100 SDR 11 (ISO S5)
- 10 bar Gas / 16 bar Water
- With integrated cutter to tap live mains under pressure
- Complete with moulded-on lower part
- 4 mm pin connectors
- Limited path fusion indicators
- Long fusion outlet
- O-ring-sealed screw cap

d (mm)	d1 (mm)	Code	Weight (kg)	d2 (mm)	H (mm)	H1 (mm)	L (mm)	L1 (mm)	z (mm)	SDR pipe
63	20	193 131 932	0.368	25	146	44	144	76	110	9 - 11
63	25	193 131 933	0.393	25	146	44	144	76	110	9 - 11
63	32	193 131 934	0.376	25	146	44	144	76	110	9 - 11
90	20	193 131 952	0.494	32	198	61	162	76	115	9 - 17.6
90	25	193 131 953	0.503	32	198	61	162	76	115	9 - 17.6
90	32	193 131 954	0.505	32	198	61	162	76	115	9 - 17.6
90	63	193 131 957	0.667	32	198	61	162	76	115	9 - 17.6
110	20	193 131 962	0.560	32	208	71	162	76	115	9 - 17.6
110	25	193 131 963	0.570	32	208	71	162	76	115	9 - 17.6
110	32	193 131 964	0.574	32	208	71	162	76	125	9 - 17.6
110	63	193 131 967	0.684	32	208	71	162	100	160	9 - 17.6
125	20	193 131 972	0.562	32	216	79	162	76	120	9 - 17.6
125	25	193 131 973	0.552	32	216	79	162	76	120	9 - 17.6
125	32	193 131 974	0.574	32	216	79	162	76	120	9 - 17.6
125	63	193 131 977	0.704	32	216	79	162	76	120	9 - 17.6
160	20	193 131 992	0.631	32	233	96	162	76	120	9 - 17.6
160	25	193 131 993	0.641	32	233	96	162	76	125	9 - 17.6
160	32	193 131 994	0.648	32	233	96	162	76	130	9 - 17.6
160	63	193 131 997	0.794	32	233	96	162	100	170	9 - 17.6

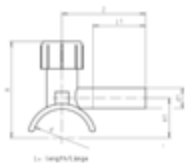

Tapping saddle Monobloc

- PE 100 SDR 11 (ISO S5)
- 10 bar Gas / 16 bar Water
- With integrated cutter to tap live mains under pressure
- Complete with lower part
- 4 mm pin connectors
- Fusion indicator
- Long fusion outlet
- O-ring-sealed screw cap

d (mm)	d1 (mm)	Code	Weight (kg)	d2 (mm)	H (mm)	H1 (mm)	L (mm)	L1 (mm)	z (mm)	SDR pipe
32	20	193 281 459	0.156	12	83	29	101	65	90	11



Tapping saddle Monobloc version

- PE 100 SDR 11 (ISO S5)
- 10 bar Gas / 16 bar Water
- With integrated cutter to tap live mains under pressure
- Complete with lower part
- 4 mm pin connectors
- Limited path fusion indicators
- Long fusion outlet
- O-ring-sealed screw cap

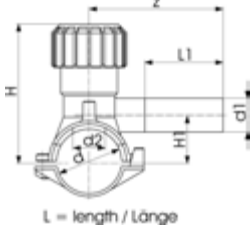

d (mm)	d1 (mm)	Code	Weight (kg)	d2 (mm)	H (mm)	H1 (mm)	L (mm)	L1 (mm)	z (mm)	SDR pipe
40	20	193 131 412	0.225	16	99	33	103	70	102	9 - 11
40	25	193 131 413	0.226	16	99	33	103	70	102	9 - 11
40	32	193 131 414	0.225	16	99	33	103	70	120	9 - 11
50	20	193 131 422	0.214	16	104	38	103	70	102	9 - 11
50	25	193 131 423	0.212	16	104	38	103	70	102	9 - 11
50	32	193 131 424	0.228	16	104	38	103	70	120	9 - 11
63	32	193 131 434	0.425	25	134	44	126	70	130	9 - 17.6



Tapping saddle (kit) Monobloc version

- PE 100 SDR 11 (ISO S5)
- 10 bar Gas / 16 bar Water
- With integrated cutter to tap live mains under pressure
- Complete with lower part
- 4 mm pin connectors
- Limited path fusion indicators
- Long fusion outlet
- O-ring-sealed screw cap
- Supplied as Kit with enclosed service line fitting (ELGEF Plus Coupler or Reducer)

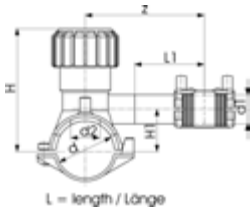

d (mm)	d1 (mm)	Code	Weight (kg)	d2 (mm)	H (mm)	H1 (mm)	L (mm)	L1 (mm)	z (mm)	SDR pipe
40	20	193 132 412	0.278	16	99	33	103	70	102	9 - 11
40	25	193 132 413	0.289	16	99	33	103	70	102	9 - 11
40	32	193 132 414	0.284	16	99	33	103	70	120	9 - 11
50	20	193 132 422	0.325	16	105	38	103	70	102	9 - 11
50	25	193 132 423	0.273	16	105	38	103	70	102	9 - 11
50	32	193 132 424	0.296	16	105	38	103	70	120	9 - 11
63	40	193 132 435	0.461	25	134	44	126	70	130	11 - 17.6



Tapping saddle (kit)
With 360° rotatable outlet

- PE 100 SDR 11 (ISO S5)
 - 10 bar Gas / 16 bar Water
 - With integrated cutter to tap live mains under pressure
 - Complete with lower part
 - 4 mm pin connectors
 - Limited path fusion indicators
 - Long fusion outlet
 - O-ring-sealed screw cap
 - Supplied as Kit with enclosed service line fitting (ELGEF Plus Coupler or Reducer)
 - d355-400mm. Not suitable for pipes if wall thickness is larger than SDR17 pipes.
- Topload: delivery without lower part for assembling as Top Load with tool no. 799.350.477; angle adaptor (799.350.340) for fusion cable required

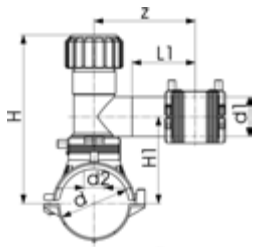
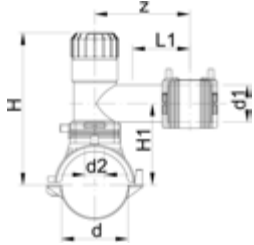

L = length / Länge

d	d1	Code	Weight	d2	H	H1	L	L1	z	SDR pipe
(mm)	(mm)		(kg)	(mm)	(mm)	(mm)	(mm)	(mm)	(mm)	
63	20	193 132 402	0.754	32	186	108	165	76	130	9 - 11
63	25	193 132 403	0.761	32	186	108	165	76	130	9 - 11
63	32	193 132 404	0.773	32	186	108	165	76	130	9 - 11
63	40	193 132 405	0.798	32	186	108	165	76	130	9 - 11
63	50	193 132 436	1.619	32	234	112	165	100	160	9 - 11
63	63	193 132 437	1.623	32	234	112	165	100	160	9 - 11
75	20	193 132 442	0.879	32	191	113	165	76	130	9 - 11
75	25	193 132 443	0.900	32	191	113	165	76	130	9 - 11
75	32	193 132 444	0.917	32	191	113	165	76	130	9 - 11
75	40	193 132 445	0.958	32	240	118	165	76	160	9 - 11
75	50	193 132 446	1.748	32	240	118	165	100	160	9 - 11
75	63	193 132 447	1.753	32	240	118	165	100	160	9 - 11
90	20	193 132 452	0.856	32	199	121	165	76	130	9 - 17.6
90	25	193 132 453	0.858	32	199	121	165	76	130	9 - 17.6
90	32	193 132 454	0.857	32	199	121	165	76	130	9 - 17.6
90	40	193 132 455	0.780	32	199	126	165	76	130	9 - 17.6
90	50	193 132 456	1.711	32	248	126	165	100	160	9 - 17.6
90	63	193 132 457	1.707	32	248	126	165	100	160	9 - 17.6
110	20	193 132 462	0.907	32	209	131	165	76	130	9 - 17.6
110	25	193 132 463	0.905	32	209	131	165	76	130	9 - 17.6
110	32	193 132 464	0.875	32	209	131	165	76	130	9 - 17.6
110	40	193 132 465	0.961	32	209	136	165	76	130	9 - 17.6
110	50	193 132 466	1.133	35	258	136	165	100	160	9 - 17.6
110	63	193 132 467	1.330	35	258	136	165	100	160	9 - 17.6
125	20	193 132 472	0.938	32	216	138	165	76	130	9 - 17.6
125	25	193 132 473	0.943	32	216	138	165	76	130	9 - 17.6
125	32	193 132 474	0.955	32	216	138	165	76	130	9 - 17.6
125	40	193 132 475	0.964	32	216	143	165	76	130	9 - 17.6
125	50	193 132 476	1.374	35	256	143	165	100	160	9 - 17.6
125	63	193 132 477	1.161	35	256	143	165	100	160	9 - 17.6
140	20	193 132 482	0.941	32	234	146	165	76	130	9 - 17.6
140	25	193 132 483	0.944	32	234	146	165	76	130	9 - 17.6
140	32	193 132 484	0.972	32	234	146	165	76	130	9 - 17.6
140	40	193 132 485	1.020	32	234	146	165	76	130	9 - 17.6
140	50	193 132 486	1.835	35	283	151	165	100	160	9 - 17.6
140	63	193 132 487	1.833	35	283	151	165	100	160	9 - 17.6
160	20	193 132 492	0.910	32	234	156	165	76	130	9 - 17.6
160	25	193 132 493	0.933	32	234	156	165	76	130	9 - 17.6
160	32	193 132 494	0.954	32	234	156	165	76	130	9 - 17.6
160	40	193 132 495	0.965	32	234	161	165	76	130	9 - 17.6
160	50	193 132 496	1.375	35	283	161	165	100	160	9 - 17.6
160	63	193 132 497	1.378	35	283	161	165	100	160	9 - 17.6
180	20	193 132 502	1.020	32	244	166	165	71	130	9 - 26
180	25	193 132 503	1.057	32	244	166	165	71	130	9 - 26
180	32	193 132 504	1.045	32	244	166	165	76	130	9 - 26
180	40	193 132 505	1.122	32	244	171	165	76	130	9 - 26
180	50	193 132 506	1.938	35	293	171	165	100	160	9 - 26
180	63	193 132 507	1.918	35	293	171	165	100	160	9 - 26

table continued on the next page

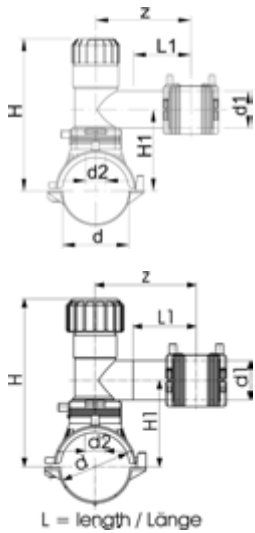

d (mm)	d1 (mm)	Code	Weight (kg)	d2 (mm)	H (mm)	H1 (mm)	L (mm)	L1 (mm)	z (mm)	SDR pipe
200	20	193 132 512	1.065	32	254	176	165	76	130	9 - 26
200	25	193 132 513	1.065	32	254	176	165	71	130	9 - 26
200	32	193 132 514	1.095	32	254	176	165	76	130	9 - 26
200	40	193 132 515	1.131	32	254	181	165	76	130	9 - 26
200	50	193 132 516	1.957	35	303	181	165	100	160	9 - 26
200	63	193 132 517	1.900	35	303	181	165	100	160	9 - 26
225	20	193 132 522	1.460	32	266	188	165	71	130	11 - 26
225	25	193 132 523	0.991	32	266	188	165	71	130	11 - 26
225	32	193 132 524	1.095	32	266	188	165	76	130	11 - 26
225	40	193 132 525	1.134	32	266	193	165	76	130	11 - 26
225	50	193 132 526	1.921	35	315	193	165	100	160	11 - 26
225	63	193 132 527	1.951	35	315	193	165	100	160	11 - 26
250	20	193 132 532	1.079	32	279	201	165	76	130	11 - 26
250	25	193 132 533	1.095	32	279	201	165	76	130	11 - 26
250	32	193 132 534	1.092	32	279	201	165	76	130	11 - 26
250	40	193 132 535	1.113	32	279	206	165	76	160	11 - 26
250	50	193 132 536	1.971	35	328	206	165	100	160	11 - 26
250	63	193 132 537	1.923	35	328	206	165	100	160	11 - 26
Topload	280	193 132 544	1.455	35	343	206	165	100	160	11 - 26
Topload	280	193 132 545	1.500	35	343	206	165	100	160	11 - 26
Topload	280	193 132 546	1.500	35	343	206	165	100	160	11 - 26
Topload	280	193 132 547	1.510	35	343	206	165	100	160	11 - 26
Topload	315 - 355	193 132 554	1.648	35	381	206	165	100	160	17 - 33
Topload	315 - 355	193 132 555	1.015	35	381	206	165	100	160	17 - 33
Topload	315 - 355	193 132 556	1.440	35	381	206	165	100	160	17 - 33
Topload	315 - 355	193 132 557	1.602	35	381	206	165	100	160	17 - 33



Tapping saddle with 360° rotatable outlet

- PE 100 SDR 11 (ISO S5)
 - 10 bar Gas / 16 bar Water
 - With integrated cutter to tap live mains under pressure
 - Complete with lower part
 - 4 mm pin connectors
 - Limited path fusion indicators
 - Long fusion outlet
 - O-ring-sealed screw cap
 - d355-400mm. Not suitable for pipes if wall thickness is larger than SDR17 pipes.
- Topload: delivery without lower part for assembling as Top Load with tool no. 799.350.477; angle adaptor (799.350.340) for fusion cable required
- * Moulded-on lower clamp

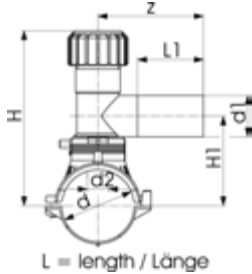

d	d1	Code	Weight	d2	H	H1	L	L1	z	SDR pipe	
(mm)	(mm)		(kg)	(mm)	(mm)	(mm)	(mm)	(mm)	(mm)		
63	20	193 131 402	0.697	32	186	108	165	71	130	9 - 11	
63	25	193 131 403	0.637	32	186	108	165	71	130	9 - 11	
63	32	193 131 404	0.701	32	186	108	165	76	130	9 - 11	
63	40	193 131 405	0.718	32	186	108	165	81	137	9 - 11	
63	63	193 131 437	1.426	32	134	112	165	100	160	9 - 11	
75	20	193 131 442	0.831	32	191	113	165	71	130	9 - 11	
75	25	193 131 443	0.830	32	191	113	165	71	130	9 - 11	
75	32	193 131 444	0.812	32	191	113	165	76	130	9 - 11	
75	40	193 131 445	0.849	32	191	113	165	81	137	9 - 11	
75	63	193 131 447	1.549	32	240	118	165	100	160	9 - 11	
90	20	193 131 452	0.794	32	199	121	165	71	130	9 - 17.6	
90	25	193 131 453	0.790	32	199	121	165	71	130	9 - 17.6	
90	32	193 131 454	0.770	32	199	121	165	76	130	9 - 17.6	
90	40	193 131 455	0.811	32	199	121	165	81	137	9 - 17.6	
90	63	193 131 457	1.494	32	248	126	165	100	160	9 - 17.6	
*	110	20	193 131 462	0.826	32	209	131	182	71	130	9 - 17.6
*	110	25	193 131 463	0.808	32	209	131	182	71	130	9 - 17.6
*	110	32	193 131 464	0.831	32	209	131	182	76	130	9 - 17.6
*	110	40	193 131 465	0.805	32	209	131	182	81	137	9 - 17.6
*	110	63	193 131 467	1.097	35	258	136	182	100	160	9 - 17.6
125	20	193 131 472	0.880	32	216	138	165	71	130	9 - 17.6	
125	25	193 131 473	0.878	32	216	138	165	71	130	9 - 17.6	
125	32	193 131 474	0.878	32	216	138	165	76	130	9 - 17.6	
125	40	193 131 475	0.874	32	216	138	165	81	137	9 - 17.6	
125	63	193 131 477	1.184	35	265	143	165	100	160	9 - 17.6	
140	20	193 131 482	0.887	32	233	146	165	71	130	9 - 17.6	
140	25	193 131 483	0.874	32	233	146	165	71	130	9 - 17.6	
140	32	193 131 484	0.894	32	233	146	165	76	130	9 - 17.6	
140	40	193 131 485	0.920	32	233	146	165	81	137	9 - 17.6	
140	63	193 131 487	1.180	35	273	151	165	100	160	9 - 17.6	
*	160	20	193 131 492	0.916	32	243	156	182	71	130	9 - 17.6
*	160	25	193 131 493	0.912	32	243	156	182	71	130	9 - 17.6
*	160	32	193 131 494	0.915	32	243	156	182	76	130	9 - 17.6
*	160	40	193 131 495	0.936	32	243	156	182	81	137	9 - 17.6
*	160	63	193 131 497	1.221	35	283	161	182	100	160	9 - 17.6
180	20	193 131 502	0.994	32	244	166	165	71	130	9 - 26	
180	25	193 131 503	1.001	32	244	166	165	71	130	9 - 26	
180	32	193 131 504	0.957	32	244	166	165	76	130	9 - 26	
180	40	193 131 505	1.007	32	244	166	165	81	137	9 - 26	
180	63	193 131 507	1.587	35	293	171	165	100	160	9 - 26	
200	20	193 131 512	1.015	32	254	176	165	71	130	9 - 26	
200	25	193 131 513	1.015	32	254	176	165	71	130	9 - 26	
200	32	193 131 514	0.985	32	254	176	165	76	130	9 - 26	
200	40	193 131 515	1.024	32	254	176	165	81	137	9 - 26	
200	63	193 131 517	1.290	35	303	181	165	100	160	9 - 26	
225	20	193 131 522	1.016	32	266	188	165	71	130	11 - 26	
225	25	193 131 523	1.025	32	266	188	165	71	130	11 - 26	
225	32	193 131 524	1.019	32	266	188	165	76	130	11 - 26	
225	40	193 131 525	1.029	32	266	188	165	81	137	11 - 26	

table continued on the next page

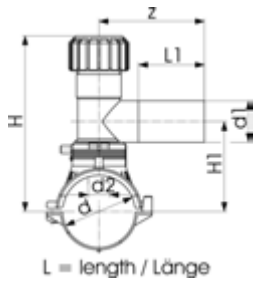

	d (mm)	d1 (mm)	Code	Weight (kg)	d2 (mm)	H (mm)	H1 (mm)	L (mm)	L1 (mm)	z (mm)	SDR pipe
	225	63	193 131 527	1.738	35	315	193	165	100	160	11 - 26
	250	20	193 131 532	1.025	32	279	201	165	76	130	11 - 26
	250	25	193 131 533	1.026	32	279	201	165	76	130	11 - 26
	250	32	193 131 534	0.996	32	279	201	165	76	130	11 - 26
	250	40	193 131 535	1.008	32	279	201	165	81	137	11 - 26
	250	63	193 131 537	1.733	35	328	206	165	100	160	11 - 26
Topload	280	63	193 131 547	1.478	35	343	206	165	100	160	11 - 26
Topload	315-355	63	193 131 557	1.481	35	381	206	165	100	160	17 - 33
Topload	400	63	193 131 577	1.473	35	403	206	165	100	160	17 - 33



Tapping saddle With 360° rotatable outlet

- PE 100 SDR 11 (ISO S5)
 - 10 bar Gas / 16 bar Water
 - With integrated cutter to tap live mains under pressure
 - **Suitable to tap SDR11 pipes**
 - 4 mm pin connectors
 - Limited path fusion indicators
 - Long fusion outlet
 - O-ring-sealed screw cap
- Topload: delivery without lower part for assembling as Top Load with tool no. 799.350.477

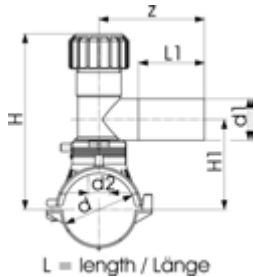

	d (mm)	d1 (mm)	Code	Weight (kg)	d2 (mm)	H (mm)	H1 (mm)	L (mm)	L1 (mm)	z (mm)	SDR pipe
	315-355	63	193 131 867	1.473	33	328	206	165	100	160	11 - 33
	400	63	193 131 877	1.473	33	328	206	165	100	160	11 - 33



Tapping saddle with gas-stop type 1-5 bar Monobloc version

- PE 100 SDR 11 (ISO S5)
- 5 bar Gas (for pressure 1 bar - 5 bar)
- With integrated cutter to tap live mains under pressure
- Complete with lower part
- Gas-Stop System Pipelife (GS 20/1 or GS 32/1)
- **Without overflow orifice**
- Set comes with Gas-Stop pre-assembled
- Installation instructions of Gas-Stop manufacturer are to be observed
- 4 mm pin connectors
- Limited path fusion indicators
- Long fusion outlet
- O-ring-sealed screw cap

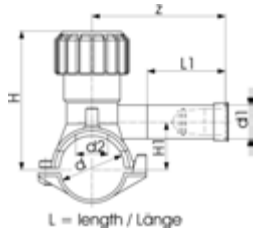

	d (mm)	d1 (mm)	Code	Weight (kg)	d2 (mm)	H (mm)	H1 (mm)	L (mm)	L1 (mm)	z (mm)	Vn max (m³/h)	SDR pipe
	40	20	193 281 113	0.214	16	99	33	103	70	102	25	9 - 11
	40	32	193 281 152	0.237	16	99	33	103	70	120	100	9 - 11

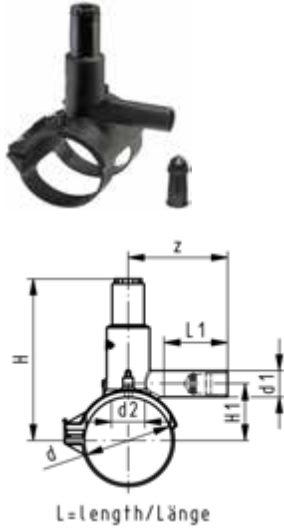

Tapping saddle with gas-stop 1-5 bar Monobloc version

- PE 100 SDR 11 (ISO S5)
- 5 bar Gas (for pressure 1 bar -5 bar)
- With integrated cutter to tap live mains under pressure
- Complete with moulded-on lower part
- **Without overflow orifice**
- Set comes with Gas-Stop pre-assembled
- Installation instructions of Gas-Stop manufacturer are to be observed
- 4 mm pin connectors
- Limited path fusion indicators
- Long fusion outlet
- O-ring-sealed screw cap

d (mm)	d1 (mm)	Code	Weight (kg)	d2 (mm)	H (mm)	H1 (mm)	L (mm)	L1 (mm)	z (mm)	Vn max (m ³ /h)	SDR pipe
63	20	193 130 432	0.368	25	146	44	144	76	110	25	9 - 11
63	32	193 130 434	0.412	25	146	44	144	76	110	100	9 - 11
90	20	193 130 452	0.524	32	198	61	162	76	115	25	9 - 17.6
90	32	193 130 454	0.520	32	198	61	162	76	115	100	9 - 17.6
110	20	193 130 462	0.552	32	208	71	162	76	115	25	9 - 17.6
110	32	193 130 464	0.620	32	208	71	162	76	125	100	9 - 17.6
125	20	193 130 472	0.664	32	216	79	162	76	120	25	9 - 17.6
125	32	193 130 474	0.628	32	216	79	162	76	120	100	9 - 17.6
160	20	193 130 492	0.672	32	233	96	162	76	120	25	9 - 17.6
160	32	193 130 494	0.786	32	233	96	162	76	130	100	9 - 17.6



Tapping saddle with gas-stop 1-5 bar With 360° rotatable outlet

- PE 100 SDR 11 (ISO S5)
- 5 bar Gas (for pressure 1 bar -5 bar)
- With integrated cutter to tap live mains under pressure
- Gas-Stop System Pipelife Type GS 20/1, 32/1 or 63/1 UE
- **Without overflow orifice**
- Set comes with Gas-Stop pre-assembled
- Installation instructions of Gas-Stop manufacturer are to be observed
- Complete with lower part
- 4 mm pin connectors
- Limited path fusion indicators
- Long fusion outlet
- O-ring-sealed screw cap

d (mm)	d1 (mm)	Code	Weight (kg)	d2 (mm)	H (mm)	H1 (mm)	L (mm)	L1 (mm)	z (mm)	Vn max (m ³ /h)	SDR pipe
63	63	193 281 159	1.548	32	134	112	165	100	160	280	9 - 11
90	20	193 281 435	0.728	25	199	121	165	71	130	25	9 - 17.6
90	32	193 281 154	0.728	25	199	121	165	76	130	100	9 - 17.6
90	63	193 281 160	1.642	32	248	126	165	100	160	280	9 - 17.6
110	20	193 281 437	0.875	25	209	131	165	71	130	25	9 - 17.6
110	32	193 281 155	0.873	25	209	131	165	76	130	100	9 - 17.6
110	63	193 281 161	1.691	35	258	136	165	100	160	280	9 - 17.6
125	20	193 281 438	0.895	25	216	138	165	71	130	25	9 - 17.6
125	32	193 281 156	0.869	25	216	138	165	76	130	100	9 - 17.6
125	63	193 281 162	1.724	35	265	143	165	100	160	280	9 - 17.6
160	20	193 281 439	0.909	25	243	156	165	71	130	25	9 - 17.6
160	32	193 281 157	0.909	25	243	156	165	76	130	100	9 - 17.6
160	63	193 281 163	1.737	35	283	161	165	100	160	280	9 - 17.6
225	20	193 281 122	1.011	25	266	188	165	71	130	25	11 - 26
225	32	193 281 158	1.011	25	266	188	165	76	130	100	11 - 26
225	63	193 281 164	1.864	35	315	193	165	100	160	280	11 - 26



Tapping saddle with gas-stop 0.025 - 1.0 bar
With 360° rotatable outlet

- PE 100 SDR 11 (ISO S5)
- 1 bar Gas (for pressures from **25 mbar to 1 bar**)
- With integrated cutter to tap live mains under pressure
- Gas-Stop System Pipelife Type AD (GS 32/25 UE or GS 63/25 UE)
- **With overflow orifice**
- Set comes with Gas-Stop pre-assembled
- Installation instructions of Gas-Stop manufacturer are to be observed
- Complete with lower part
- 4 mm pin connectors
- Limited path fusion indicators
- Long fusion outlet
- O-ring-sealed screw cap

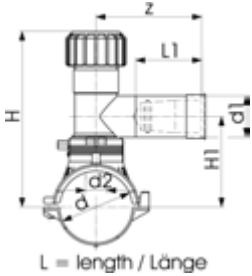

d (mm)	d1 (mm)	Code	Weight (kg)	d2 (mm)	H (mm)	H1 (mm)	L (mm)	L1 (mm)	z (mm)	Vn max (m ³ /h)	SDR pipe
63	32	193 130 604	0.728	32	186	108	165	76	130	10	9 - 11
63	63	193 130 637	1.556	32	134	112	165	100	160	40	9 - 11
75	32	193 130 644	0.854	32	191	113	165	76	130	10	9 - 11
75	63	193 130 647	1.680	32	240	118	165	100	160	40	9 - 11
90	32	193 130 654	0.814	32	199	121	165	76	130	10	9 - 17.6
90	63	193 130 657	1.642	32	248	126	165	100	160	40	9 - 17.6
110	32	193 130 664	0.884	32	209	131	165	76	130	10	9 - 17.6
110	63	193 130 667	1.691	35	258	136	165	100	160	40	9 - 17.6
125	32	193 130 674	0.902	32	216	138	165	76	130	10	9 - 17.6
125	63	193 130 677	1.724	35	265	143	165	100	160	40	9 - 17.6
140	32	193 130 684	0.913	32	233	146	165	76	130	10	9 - 17.6
140	63	193 130 687	1.740	35	273	151	165	100	160	40	9 - 17.6
160	32	193 130 694	0.909	32	243	156	165	76	130	10	9 - 17.6
160	63	193 130 697	1.737	35	283	161	165	100	160	40	9 - 17.6
180	32	193 130 704	1.015	32	244	166	165	76	130	10	9 - 26
180	63	193 130 707	1.843	35	293	171	165	100	160	40	9 - 26
200	32	193 130 714	1.034	32	254	176	165	76	130	10	9 - 26
200	63	193 130 717	1.862	35	303	181	165	100	160	40	9 - 26
225	32	193 130 724	1.027	32	266	188	165	76	130	10	11 - 26
225	63	193 130 727	1.864	35	315	193	165	100	160	40	11 - 26
250	32	193 130 734	1.048	32	279	201	165	76	130	10	11 - 26
250	63	193 130 737	1.876	35	328	206	165	100	160	40	11 - 26

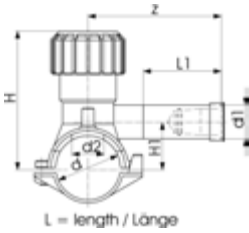

**Tapping saddle with gas-stop 0.2 - 5 bar
Monobloc version**

- **PE 100 SDR 11** (ISO S5)
- 5 bar Gas (for pressures from **200 mbar to 5 bar**)
- With integrated cutter to tap live mains under pressure
- Gas-Stop System Pipelife Type S (GS 32/200 UE)
- **With overflow orifice**
- Set comes with Gas-Stop pre-assembled
- Installation instructions of Gas-Stop manufacturer are to be observed
- Complete with lower part
- 4 mm pin connectors
- Limited path fusion indicators
- Long fusion outlet
- O-ring-sealed screw cap

d	d1	Code	Weight
(mm)	(mm)		(kg)
40	32	193 130 814	0.290
50	32	193 130 824	0.283
63	32	193 130 834	0.446

D2	d2	H	H1	L	L1	z	Vn max	SDR pipe
(mm)	(mm)	(mm)	(mm)	(mm)	(mm)	(mm)	(m ³ /h)	
16	16	99	33	103	76	120	45	9 - 11
16	16	104	38	103	76	120	45	9 - 11
25	25	134	44	126	76	130	45	9 - 17.6



**Tapping saddle with gas-stop 0.2 - 5 bar
With 360° rotatable outlet**

- PE 100 SDR 11 (ISO S5)
- 5 bar Gas (for pressures from **200 mbar to 5 bar**)
- With integrated cutter to tap live mains under pressure
- Gas-Stop System Pipelife Type S (GS 32/200 UE or GS 63/200 UE)
- **With overflow orifice**
- Set comes with Gas-Stop pre-assembled
- Installation instructions of Gas-Stop manufacturer are to be observed
- Complete with lower part
- 4 mm pin connectors
- Limited path fusion indicators
- Long fusion outlet
- O-ring-sealed screw cap

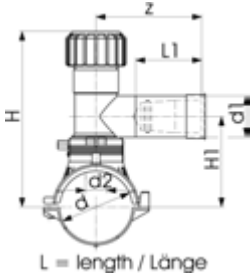

d (mm)	d1 (mm)	Code	Weight (kg)	d2 (mm)	H (mm)	H1 (mm)	L (mm)	L1 (mm)	z (mm)	Vn max (m ³ /h)	SDR pipe
63	32	193 130 804	0.715	32	186	108	165	76	130	45	9 - 11
63	63	193 130 837	1.540	35	134	112	165	100	160	180	9 - 11
75	32	193 130 844	0.854	32	191	113	165	76	130	45	9 - 11
75	63	193 130 847	1.680	35	240	118	165	100	160	180	9 - 11
90	32	193 130 854	0.813	32	199	121	165	76	130	45	9 - 17.6
90	63	193 130 857	1.642	35	248	126	165	100	160	180	9 - 17.6
110	32	193 130 864	0.877	32	209	131	165	76	130	45	9 - 17.6
110	63	193 130 867	1.691	35	258	136	165	100	160	180	9 - 17.6
125	32	193 130 874	0.897	32	216	138	165	76	130	45	9 - 17.6
125	63	193 130 877	1.709	35	265	143	165	100	160	180	9 - 17.6
140	32	193 130 884	0.913	32	233	146	165	76	130	45	9 - 17.6
140	63	193 130 887	1.740	35	273	151	165	100	160	180	9 - 17.6
160	32	193 130 894	0.909	32	243	156	165	76	130	45	9 - 17.6
160	63	193 130 897	1.737	35	283	161	165	100	160	180	9 - 17.6
180	32	193 130 904	1.222	32	244	166	165	76	130	45	9 - 26
180	63	193 130 907	1.843	35	293	171	165	100	160	180	9 - 26
200	32	193 130 914	1.034	32	254	176	165	76	130	45	9 - 26
200	63	193 130 917	1.862	35	303	181	165	100	160	180	9 - 26
225	32	193 130 924	1.027	32	266	188	165	76	130	45	11 - 26
225	63	193 130 927	1.828	35	315	193	165	100	160	180	11 - 26
250	32	193 130 934	1.048	32	279	201	165	76	130	45	11 - 26
250	63	193 130 937	1.876	35	328	206	165	100	160	180	11 - 26

Pressure tapping valves

Pressure tapping valve With 360° rotatable outlet

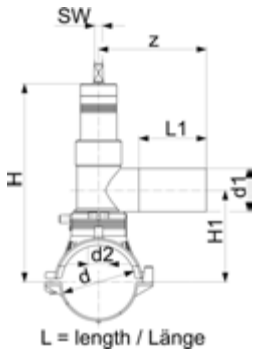

- PE 100 SDR 11 (ISO S5)
- 10 bar Gas / 16 bar Water
- With integrated drill bit to tap live mains under pressure
- Complete with lower part and premounted PE100 coated valve piece
- The valve is closed clockwise
- Number of turns to fully open or close valve is 13 for outlet d32
- Number of turns to fully open or close valve is 28 for outlet d63
- Spindle size (SW) 14
- 4 mm pin connectors
- Limited path fusion indicators
- Long fusion outlet
- * Moulded-on lower clamp

d	d1	Code	Weight	d2	H	H1	L	L1	z	SDR pipe	
(mm)	(mm)		(kg)	(mm)	(mm)	(mm)	(mm)	(mm)	(mm)		
63	32	193 155 234	1.811	21	202	97	165	70	127	9 - 11	
63	63	193 155 237	2.680	31	272	112	165	100	160	9 - 11	
75	32	193 155 244	1.943	21	208	103	165	70	127	9 - 11	
75	63	193 155 247	2.749	31	278	118	165	100	160	9 - 11	
90	32	193 155 254	1.894	21	216	111	165	70	127	9 - 17.6	
90	63	193 155 257	2.781	31	286	126	165	100	160	9 - 17.6	
*	110	32	193 155 264	1.896	21	226	121	165	70	127	9 - 17.6
*	110	63	193 155 267	2.739	31	296	136	165	100	160	9 - 17.6
125	32	193 155 274	1.986	21	233	128	165	70	127	9 - 17.6	
125	63	193 155 277	2.867	31	303	143	165	100	160	9 - 17.6	
140	32	193 155 284	2.009	21	241	136	165	70	127	9 - 17.6	
140	63	193 155 287	2.908	31	311	151	165	100	160	9 - 17.6	
*	160	32	193 155 294	2.029	21	251	146	165	70	127	9 - 17.6
*	160	63	193 155 297	2.913	31	321	161	165	100	160	9 - 17.6
180	32	193 155 304	2.111	21	261	156	165	70	127	9 - 26	
180	63	193 155 307	2.923	31	331	171	165	100	160	9 - 26	
200	32	193 155 314	2.127	21	271	166	165	70	127	9 - 26	
200	63	193 155 317	3.007	31	341	181	165	100	160	9 - 26	
225	32	193 155 324	2.091	21	281	178	165	70	127	11 - 26	
225	63	193 155 327	2.932	31	353	193	165	100	160	11 - 26	
250	63	193 155 337	2.978	31	366	206	165	100	160	11 - 26	



**Pressure tapping valve
With 360° rotatable outlet**

- PE 100 SDR 11 (ISO S5)
- 10 bar Gas / 16 bar Water
- With integrated drill bit to tap live mains under pressure
- **Suitable for pipes with wall thickness between 7 and 21 mm only.**
- Complete with lower part and premounted PE100 coated valve piece
- The valve is closed clockwise
- Number of turns to fully open or close valve is 13 for outlet d32
- Number of turns to fully open or close valve is 28 for outlet d63
- Spindle size (SW) 14
- 4 mm pin connectors
- Limited path fusion indicators
- Long fusion outlet

Topload: delivery without lower part for assembling as Top Load with tool no. 799.350.477; angle adaptor (799.350.340) for fusion cable required

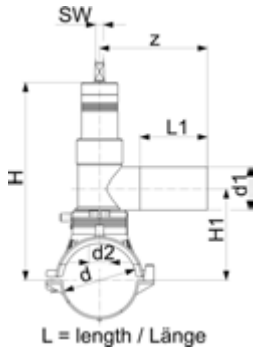

	d	d1	Code	Weight	L1	H1	z	L	H	d2	SDR pipe
	(mm)	(mm)		(kg)	(mm)	(mm)	(mm)	(mm)	(mm)	(mm)	
	250	32	193 155 334	2.096	70	191	127	165	293	21	17 - 26
Topload	280	32	193 155 344	1.835	70	191	127	165	293	21	17 - 26
Topload	280	63	193 155 347	3.000	100	206	160	165	366	31	17 - 26
Topload	315 - 355	32	193 155 354	3.000	70	191	127	165	293	21	17 - 33
Topload	315 - 355	63	193 155 357	2.696	100	206	160	165	366	31	17 - 33
Topload	400	32	193 155 374	3.000	70	191	127	165	293	21	21 - 33
Topload	400	63	193 155 377	3.000	100	206	160	165	366	31	21 - 33

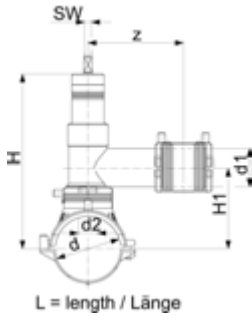

**Pressure tapping valve (kit)
With 360° rotatable outlet**

- PE 100 SDR 11 (ISO S5)
- 10 bar Gas / 16 bar Water
- With integrated drill bit to tap live mains under pressure
- Complete with lower part and premounted PE100 coated valve piece
- The valve is closed clockwise
- Number of turns to fully open or close valve is 13 for outlet d32
- Number of turns to fully open or close valve is 28 for outlet d 40, d 50, d 63
- Spindle size (SW) 14
- 4 mm pin connectors
- Limited path fusion indicators
- Long fusion outlet
- Supplied as Kit with enclosed service line fitting (ELGEF Plus Coupler or Reducer)

d	d1	Code	Weight	d2	H	H1	L	z	SDR pipe
(mm)	(mm)		(kg)	(mm)	(mm)	(mm)	(mm)	(mm)	
63	32	193 155 034	1.864	21	202	97	165	127	9 - 11
63	40	193 155 035	2.862	31	272	112	165	160	9 - 11
63	50	193 155 036	2.879	31	272	112	165	160	9 - 11
63	63	193 155 037	2.887	31	272	112	165	160	9 - 11
75	32	193 155 044	3.243	21	208	103	165	127	9 - 11
75	40	193 155 045	3.249	31	278	118	165	160	9 - 11
75	50	193 155 046	3.261	31	278	118	165	160	9 - 11
75	63	193 155 047	3.259	31	278	118	165	160	9 - 11
90	32	193 155 054	1.962	21	216	111	165	127	9 - 17.6
90	40	193 155 055	2.957	31	286	126	165	160	9 - 17.6
90	50	193 155 056	2.970	31	286	126	165	160	9 - 17.6
90	63	193 155 057	2.924	31	286	126	165	160	9 - 17.6
110	32	193 155 064	2.030	21	226	121	165	127	9 - 17.6
110	40	193 155 065	2.984	31	296	136	165	160	9 - 17.6
110	50	193 155 066	2.696	31	296	136	165	160	9 - 17.6
110	63	193 155 067	3.010	31	296	136	165	160	9 - 17.6
125	32	193 155 074	2.039	21	233	128	165	127	9 - 17.6
125	40	193 155 075	3.007	31	303	143	165	160	9 - 17.6
125	50	193 155 076	3.023	31	303	143	165	160	9 - 17.6
125	63	193 155 077	3.058	31	303	143	165	160	9 - 17.6
140	32	193 155 084	3.301	21	241	136	165	127	9 - 17.6
140	40	193 155 085	3.040	31	311	151	165	160	9 - 17.6
140	50	193 155 086	3.315	31	311	151	165	160	9 - 17.6
140	63	193 155 087	3.313	31	311	151	165	160	9 - 17.6
160	32	193 155 094	2.057	21	251	146	165	127	9 - 17.6
160	40	193 155 095	2.980	31	321	161	165	160	9 - 17.6
160	50	193 155 096	3.022	31	321	161	165	160	9 - 17.6
160	63	193 155 097	3.025	31	321	161	165	160	9 - 17.6
180	32	193 155 104	3.410	21	261	156	165	127	9 - 26
180	40	193 155 105	3.126	31	331	171	165	160	9 - 26
180	50	193 155 106	3.181	31	331	171	165	160	9 - 26
180	63	193 155 107	3.164	31	331	171	165	160	9 - 26
200	32	193 155 114	3.431	21	271	166	165	127	9 - 26
200	40	193 155 115	3.435	31	341	181	165	160	9 - 26
200	50	193 155 116	3.453	31	341	181	165	160	9 - 26
200	63	193 155 117	3.215	31	341	181	165	160	9 - 26
225	32	193 155 124	2.195	21	281	178	165	127	11 - 26
225	40	193 155 125	3.178	31	353	193	165	160	11 - 26
225	50	193 155 126	3.120	31	353	193	165	160	11 - 26
225	63	193 155 127	3.196	31	353	193	165	160	11 - 26
250	40	193 155 135	3.449	30	366	206	165	160	11 - 26
250	50	193 155 136	3.124	30	366	206	165	160	11 - 26
250	63	193 155 137	3.221	30	366	206	165	160	11 - 26



Pressure tapping valve (kit)
With 360° rotatable outlet

- PE 100 SDR 11 (ISO S5)
 - 10 bar Gas / 16 bar Water
 - With integrated drill bit to tap live mains under pressure
 - **Suitable for pipes with wall thickness between 7 and 21 mm only.**
 - Complete with lower part and premounted PE100 coated valve piece
 - The valve is closed clockwise
 - Number of turns to fully open or close valve is 13 for outlet d32
 - Number of turns to fully open or close valve is 28 for outlet d 40, d 50, d 63
 - Spindle size (SW) 14
 - 4 mm pin connectors
 - Limited path fusion indicators
 - Long fusion outlet
 - Supplied as Kit with enclosed service line fitting (ELGEF Plus Coupler or Reducer)
- Topload: delivery without lower part for assembling as Top Load with tool no. 799.350.477; angle adaptor (799.350.340) for fusion cable required

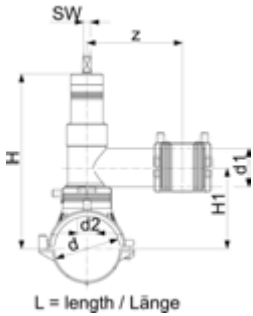

	d	d1	Code	Weight	d2	H	H1	L	z	SDR pipe
	(mm)	(mm)		(kg)	(mm)	(mm)	(mm)	(mm)	(mm)	
	250	32	193 155 134	3.443	21	293	191	165	127	17 - 26
Topload	280	32	193 155 144	3.118	21	293	191	165	127	17 - 26
Topload	280	40	193 155 145	2.913	30	366	206	165	160	17 - 26
Topload	280	50	193 155 146	3.136	30	366	206	165	160	17 - 26
Topload	280	63	193 155 147	2.719	30	366	206	165	160	17 - 26
Topload	315 - 355	32	193 155 154	3.118	21	293	191	165	127	17 - 33
Topload	315 - 355	40	193 155 155	3.124	30	366	206	165	160	17 - 33
Topload	315 - 355	50	193 155 156	3.136	30	366	206	165	160	17 - 33
Topload	315 - 355	63	193 155 157	3.134	30	366	206	165	160	17 - 33

Various parts

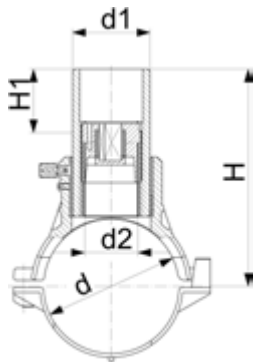

L = length / Länge

Spigot saddle with cutter

- PE 100 SDR 11 (ISO S5)
 - 10 bar Gas / 16 bar Water
 - Complete with lower part
 - 4 mm pin connectors
 - Limited path fusion indicators
 - d355-400mm. Not suitable for pipes if wall thickness is larger than SDR17 pipes.
- Topload: delivery without lower part for assembling as Top Load with tool no. 799.350.477; angle adaptor (799.350.340) for fusion cable required

	d (mm)	d1 (mm)	Code	Weight (kg)	d2 (mm)	H (mm)	H1 (mm)	L (mm)	SW (mm)	SDR pipe
	63	32	193 131 234	0.469	19	145	50	165	13	9 - 11
	63	63	193 131 237	1.036	32	152	50	165	17	9 - 11
	75	32	193 131 244	0.618	19	151	50	165	13	9 - 11
	75	63	193 131 247	1.166	32	158	50	165	17	9 - 11
	90	32	193 131 254	0.543	19	158	50	165	13	9 - 17.6
	90	63	193 131 257	1.128	32	165	50	165	17	9 - 17.6
	110	32	193 131 264	0.607	19	168	50	165	13	9 - 17.6
	110	63	193 131 267	1.195	32	175	50	165	17	9 - 17.6
	125	32	193 131 274	0.659	19	176	50	165	13	9 - 17.6
	125	63	193 131 277	1.224	32	183	50	165	17	9 - 17.6
	140	32	193 131 284	0.679	19	183	50	165	13	9 - 17.6
	140	63	193 131 287	1.224	32	190	50	165	17	9 - 17.6
	160	32	193 131 294	0.652	19	193	50	165	13	9 - 17.6
	160	63	193 131 297	0.850	32	200	50	165	17	9 - 17.6
	180	32	193 131 304	0.777	19	203	50	165	13	9 - 26
	180	63	193 131 307	1.316	32	210	50	165	17	9 - 26
	200	32	193 131 314	0.854	19	213	50	165	13	9 - 26
	200	63	193 131 317	1.352	32	220	50	165	17	9 - 26
	225	32	193 131 324	0.856	19	226	50	165	13	11 - 26
	225	63	193 131 327	1.324	32	233	50	165	17	11 - 26
	250	32	193 131 334	0.787	19	238	50	165	13	11 - 26
	250	63	193 131 337	1.348	32	245	50	165	17	11 - 26
Topload	280	63	193 131 347	0.830	35	260	50	165	17	11 - 26
Topload	315 - 355	63	193 131 357	1.094	35	298	50	165	17	17 - 33
Topload	400	63	193 131 377	0.830	35	320	50	165	17	17 - 33

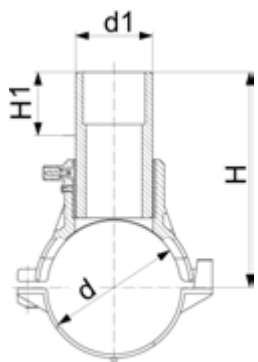

L = length / Länge

Spigot saddle

- PE 100 SDR 11 (ISO S5)
- 10 bar Gas / 16 bar Water
- Complete with lower part
- 4 mm pin connectors
- Limited path fusion indicators

Topload: delivery without lower part for assembling as Top Load with tool no. 799.350.477; angle adaptor (799.350.340) for fusion cable required

	d (mm)	d1 (mm)	Code	Weight (kg)	H (mm)	H1 (mm)	L (mm)	SDR pipe
	63	32	193 130 234	0.434	145	50	165	9 - 11
	63	63	193 130 237	0.630	152	50	165	9 - 11
	75	32	193 130 244	0.634	151	50	165	9 - 11
	75	63	193 130 247	0.536	158	50	165	9 - 11
	90	32	193 130 254	0.508	158	50	165	9 - 17.6
	90	63	193 130 257	0.573	165	50	165	9 - 17.6
	110	32	193 130 264	0.590	168	50	165	9 - 17.6
	110	63	193 130 267	0.600	175	50	165	9 - 17.6
	125	32	193 130 274	0.594	176	50	165	9 - 17.6
	125	63	193 130 277	0.660	183	50	165	9 - 17.6
	140	32	193 130 284	0.638	183	50	165	9 - 17.6
	140	63	193 130 287	0.594	190	50	165	9 - 17.6
	160	32	193 130 294	0.600	193	50	165	9 - 17.6
	160	63	193 130 297	0.658	200	50	165	9 - 17.6
	180	32	193 130 304	0.742	203	50	165	9 - 26
	180	63	193 130 307	0.771	210	50	165	9 - 26
	200	32	193 130 314	0.766	213	50	165	9 - 26
	200	63	193 130 317	0.762	220	50	165	9 - 26
	225	32	193 130 324	0.730	226	50	165	9 - 26
	225	63	193 130 327	0.782	233	50	165	9 - 26
	250	32	193 130 334	0.741	238	50	165	9 - 26
	250	63	193 130 337	0.792	245	50	165	9 - 26
Topload	280	63	193 130 347	0.400	260	50	165	9 - 26
Topload	315 - 355	63	193 130 357	0.503	298	50	165	9 - 33
Topload	400	63	193 130 377	0.400	320	50	165	9 - 33



Repair saddle

- PE 100 SDR 11 (ISO S5)
 - 10 bar Gas / 16 bar Water
 - Complete with lower part
 - 4 mm pin connectors
 - Limited path fusion indicators
 - Supplied as kit including Spigot Cap (753.961.011)
- Topload: delivery without lower part for assembling as Top Load with tool no. 799.350.477; angle adaptor (799.350.340) for fusion cable required

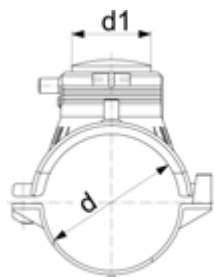

L = length / Länge

	d (mm)	d1 (mm)	Code	Weight (kg)	L (mm)	SDR pipe
	63	63	193 130 037	0.417	165	9 - 11
	75	63	193 130 047	0.574	165	9 - 11
	90	63	193 130 057	0.513	165	9 - 17.6
	110	63	193 130 067	0.565	165	9 - 17.6
	125	63	193 130 077	0.622	165	9 - 17.6
	140	63	193 130 087	0.660	165	9 - 17.6
	160	63	193 130 097	0.589	165	9 - 17.6
	180	63	193 130 107	0.733	165	9 - 26
	200	63	193 130 117	0.731	165	9 - 26
	225	63	193 130 127	0.708	165	9 - 26
	250	63	193 130 137	0.640	165	9 - 26
Topload	280	63	193 130 147	0.450	165	9 - 26
Topload	315 - 355	63	193 130 157	0.443	165	9 - 33
Topload	400	63	193 130 177	0.450	165	9 - 33



Stop-off saddle with PE-adaptor Maximum passage 50 mm

- PE 100 SDR 11 (ISO S5)
 - 10 bar Gas / 16 bar Water
 - Complete with lower part
 - Supplied as Kit with PE-Stop-Off Adaptor
 - PE Stop-Off insert
 - 4 mm pin connectors
 - Limited path fusion indicators
- Topload: delivery without lower part for assembling as Top Load with tool no. 799.350.477; angle adaptor (799.350.340) for fusion cable required

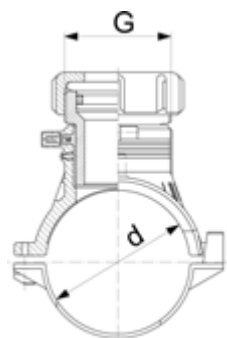

L = length / Länge

	d (mm)	G (inch)	Code	Weight (kg)	L (mm)	SDR pipe
	63	2 3/4	193 149 237	0.606	165	9 - 11
	75	2 3/4	193 149 247	0.765	165	9 - 11
	90	2 3/4	193 149 257	0.696	165	9 - 17.6
	110	2 3/4	193 149 267	0.732	165	9 - 17.6
	125	2 3/4	193 149 277	0.785	165	9 - 17.6
	140	2 3/4	193 149 287	0.820	165	9 - 17.6
	160	2 3/4	193 149 297	0.772	165	9 - 17.6
	180	2 3/4	193 149 307	0.920	165	9 - 26
	200	2 3/4	193 149 317	0.913	165	9 - 26
	225	2 3/4	193 149 327	0.910	165	9 - 26
	250	2 3/4	193 149 337	0.936	165	9 - 26
Topload	280	2 3/4	193 149 347	0.920	165	9 - 26
Topload	315 - 355	2 3/4	193 149 357	0.660	165	9 - 33
Topload	400	2 3/4	193 149 377	0.920	165	9 - 33

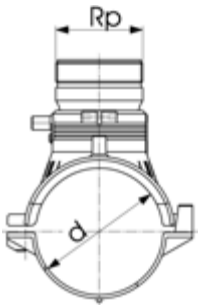

L = length / Länge

Stop-off saddle (kit)
Maximum passage 56.5 mm

- PE 100 SDR 11 (ISO S5)
 - 10 bar Gas / 16 bar Water
 - Complete with lower part
 - Stop-Off insert (CW617N) and plug
 - 4 mm pin connectors
 - Limited path fusion indicators
 - Stop-Off insert with outside thread Rp 2 1/2" and internal thread Rp 2" suited for common tapping devices permitting "gas-tight" installation
 - We recommend the following maximum cutting diameter: For main dimension d63 and d75mm: d = 39mm; For main dimension d90mm: d = 50mm
- Topload: delivery without lower part for assembling as Top Load with tool no. 799.350.477; angle adaptor (799.350.340) for fusion cable required

	d (mm)	Rp (inch)	Code	Weight (kg)	L (mm)	SDR pipe
	63	2 ½	193 149 437	1.770	165	9 - 11
	75	2 ½	193 149 447	1.900	165	9 - 11
	90	2 ½	193 149 457	1.775	165	9 - 17.6
	110	2 ½	193 149 467	1.788	165	9 - 17.6
	125	2 ½	193 149 477	1.923	165	9 - 17.6
	140	2 ½	193 149 487	1.945	165	9 - 17.6
	160	2 ½	193 149 497	1.861	165	9 - 17.6
	180	2 ½	193 149 507	2.017	165	9 - 26
	200	2 ½	193 149 517	2.092	165	9 - 26
	225	2 ½	193 149 527	2.031	165	9 - 26
	250	2 ½	193 149 537	2.058	165	9 - 26
Topload	280	2 ½	193 149 547	1.550	165	9 - 26
Topload	315 - 355	2 ½	193 149 557	1.770	165	9 - 33
Topload	400	2 ½	193 149 577	1.550	165	9 - 33

Accessories & tools



Tapping key for saddles

- With adjustable tapping depth.

Type	Code	Weight (kg)	Description
WS - 10	799 198 080	0.114	for Monobloc d 40 mm and d 50 mm
WS - 17	799 198 079	0.556	for Monobloc d 63 mm, d 90 - 160 mm and all Duobloc saddles
WS - 12.7	799 198 091	0.600	for spigot saddle with cutter



Pressure test cap for Tapping saddles

- The cap has a Rp 3/8" connection thread and is made from galvanised steel.
- **Overview of Tapping Adapter types and Pressure Test Cap**
- M For Monobloc d 40 and 50 mm (outlets d 20 - 32 mm)
- S 54 For all saddles with rotatable outlet (outlets d 20 - 40 mm) i.e. Tapping Tee d 20 - 40 mm.
- S 67 For all Saddles with rotatable outlet (outlets d 50 and 63 mm) i.e. Tapping Tee d 63 mm.

Type	Code	Weight (kg)	Description
M	799 199 282	0.116	for Monobloc d 40 mm and d 50 mm
S 54	799 199 283	0.260	for Tapping Tee d 20 - 40 mm
S 67	799 199 286	0.430	for Tapping Tee outlet d 63 mm
MB	799 199 287	0.037	for Monobloc d63-160 mm and Branch saddle outlet d160/225 mm



Tapping Adapter for saddles

- The Adapter is used for gas-free tapping under pressure. Type S 54 for tapping saddles with rotatable outlet d 20 - 40 mm (Tapping Tee d 32 mm). Type S 67 for tapping saddles with rotatable outlet d 50 - 63 mm (Tapping Tee d 63 mm).

Type	Code	Weight (kg)	Description
S 54	799 100 061	0.785	for Tapping Tee d 32 mm
S 67	799 100 062	1.011	for Tapping Tee d 63 mm



Hexagon key for saddles and branch fittings

- For tightening fixation screws.

Type	Code	Weight (kg)	Description
SW8	799 150 378	0.129	For all saddles and branch fittings

ELGEF Plus branch saddles

Branch saddles PE100

Page



Branch saddles

59



Branch saddles topload

60



Accessories & tools

63



Branch saddles

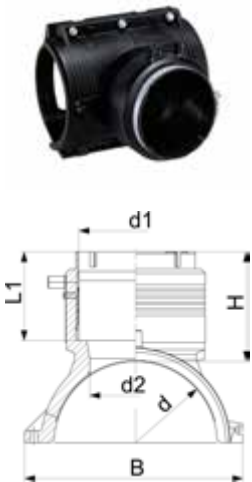

Branch saddle outlet 90 - 125 mm

- PE 100 SDR 11 (ISO S5)
- 10 bar Gas / 16 bar Water
- Branch Saddle complete, incl. lower part and 3 screws
- Additional fixing with snatch hinge
- Electrofusion outlet with integrated pipe fixation
- Protected wire without medium contact
- 4 mm pin connectors
- Limited path fusion indicators
- * Delivered without lower part. Pipe fixation with multiple use assembly toolno. 193.281.027

d (mm)	d1 (mm)	Code	Weight (kg)	H (mm)	L (mm)	L1 (mm)	B (mm)	d2 (mm)	SDR pipe	
110	90	193 135 009	1.124	101	220	82	164	65	9-17.6	
110	110	193 135 010	1.224	107	220	88	164	65	9-17.6	
125	90	193 135 019	1.134	101	220	82	179	65	9-17.6	
125	110	193 135 020	1.290	107	220	88	179	65	9-17.6	
*	140	90	193 135 029	0.982	101	220	81	195	65	9-17.6
*	140	110	193 135 030	1.087	107	220	87	195	65	9-17.6
	160	90	193 135 039	1.449	102	240	82	215	65	9-17.6
	160	110	193 135 040	1.582	108	240	88	215	86	9-17.6
	160	125	193 135 041	1.782	129	240	99	215	86	9-17.6
	180	90	193 135 049	1.672	102	260	82	237	65	9-17.6
	180	110	193 135 050	1.765	108	260	88	237	86	9-17.6
	180	125	193 135 051	2.015	129	260	99	237	86	9-17.6
	200	90	193 135 059	1.803	102	260	82	253	65	9-17.6
	200	110	193 135 060	1.963	108	260	88	253	86	9-17.6
	200	125	193 135 061	2.128	129	260	99	253	86	9-17.6
	225	90	193 135 069	2.006	102	260	82	287	65	9-17.6
	225	110	193 135 070	2.400	108	260	88	287	86	9-17.6
	225	125	193 135 071	2.312	129	260	99	287	86	9-17.6
	250	90	193 135 079	2.145	102	260	82	312	65	9-17.6
	250	110	193 135 080	2.258	108	260	88	312	86	9-17.6
	250	125	193 135 081	2.500	129	260	99	312	86	9-17.6



Cross connection branch saddle

- Enables the connection of two Branch Saddle as a cross
- Complete with screws, flat washers and nuts

d (mm)	Code	Weight (kg)
110 - 160	193 280 880	0.268
180 - 250	193 280 881	0.282



Multiple use assembly tool branch saddle d140mm

- Only to be used with Branch Saddle d140mm
- Delivered as complete Kit including screws and belt

d (mm)	Code	Weight (kg)
140	193 281 027	0.724

Branch saddles toplod

Branch saddle toplod outlet 90 - 125 mm

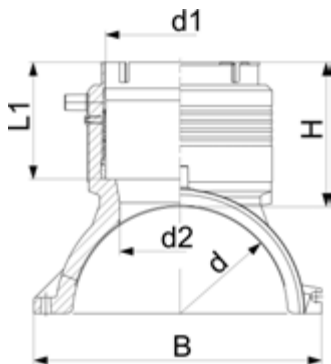

- PE 100 SDR 11 (ISO S5)
- 10 bar Gas / 16 bar Water
- Branch Saddle for assembling as Topload with tool 799.350.477; angle adaptors (799.350.340) for fusion cable required
- Electrofusion outlet with integrated pipe fixation
- Protected wire without medium contact
- 4 mm pin connectors
- Limited path fusion indicators

d (mm)	d1 (mm)	Code	Weight (kg)	H (mm)	L (mm)	L1 (mm)	B (mm)	d2 (mm)	SDR pipe
280	90	193 135 289	1.242	102	260	82	243	65	9-26
280	110	193 135 290	1.295	108	260	88	243	86	9-26
280	125	193 135 291	1.530	129	260	99	243	86	9-26
315 - 355	90	193 135 309	1.214	102	260	82	249	65	9-26
315 - 355	110	193 135 310	1.297	108	260	88	249	86	9-26
315 - 355	125	193 135 311	1.530	129	260	99	249	86	9-26
400	90	193 135 329	1.022	102	260	82	256	65	9-26
400	110	193 135 330	1.116	108	260	88	256	86	9-26
400	125	193 135 331	1.369	129	260	99	256	86	9-26
450	90	193 135 339	1.022	102	260	82	256	65	9-26
450	110	193 135 340	1.116	108	260	88	256	86	9-26
450	125	193 135 341	1.369	129	260	99	256	86	9-26
500 - 630	90	193 135 159	1.086	102	260	82	263	65	9-26
500 - 630	110	193 135 160	1.159	108	260	88	263	86	9-26
500 - 630	125	193 135 161	1.388	129	260	99	263	86	9-26



Branch saddle topload outlet 160 - 225 mm

- PE 100 SDR 11 (ISO S5)
- 10 bar Gas / 16 bar Water
- Branch Saddle installation only with installation set Topload TL225 (799.300.807)
- Angle adaptors (799.350.340) for fusion cable required
- 4 mm pin connectors
- Limited path fusion indicators
- Spigot outlet for butt- and electrofusion
- Full pressure applicable - no derating factor
- With integrated pressure test port for test cap (799.199.287)

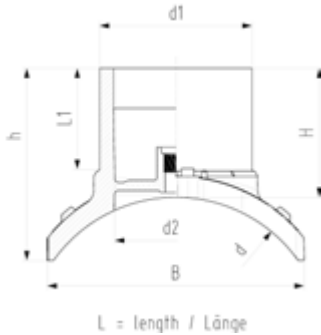

d (mm)	d1 (mm)	Code	Weight (kg)	d2 (mm)	L (mm)	L1 (mm)	h (mm)	H (mm)	B (mm)	SDR pipe
315	160	193 135 202	2.548	131	322	110	212	137	270	11-26
315	225	193 135 204	4.625	184	366	127	306	160	301	11-26
355	160	193 135 212	2.348	131	322	110	206	137	270	11-26
355	225	193 135 214	4.594	184	366	127	319	160	313	11-26
400	160	193 135 222	2.623	131	322	110	198	137	290	11-26
400	225	193 135 224	4.612	184	366	127	329	160	303	11-26
450	160	193 135 232	2.429	131	322	110	194	137	290	11-26
450	225	193 135 234	4.301	184	366	127	329	160	324	11-26
500	160	193 135 242	2.643	131	322	110	186	137	303	11-26
500	225	193 135 244	4.569	184	366	127	344	160	341	11-26
560	160	193 135 252	2.495	131	322	110	183	137	303	11-26
560	225	193 135 254	4.321	184	366	127	344	160	341	11-26
630	160	193 135 262	2.616	131	322	110	177	137	305	11-33
630	225	193 135 264	4.750	184	366	127	353	160	349	11-33
710	160	193 135 272	2.504	131	322	110	172	137	305	11-33
710	225	193 135 274	4.360	184	366	127	352	160	350	11-33
800	160	193 135 282	2.399	131	366	127	168	137	305	11-33
800	225	193 135 284	4.553	184	366	127	359	160	357	11-33
900	225	193 135 294	4.390	184	366	127	359	160	356	11-33
1000	225	193 135 304	4.262	184	366	127	359	160	356	11-33



Branch saddle topload outlet 315 mm

- PE 100 SDR 11 (ISO S5)
- 10 bar Gas / 16 bar Water
- Branch saddle installation only with installation set Topload TL500 (799.300.809)
- Angle adaptors (799.350.340) for fusion cable required
- 4 mm pin connectors
- Spigot outlet for butt- and electrofusion
- Full pressure applicable - no derating factor

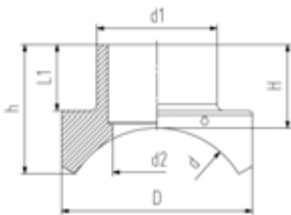

d (mm)	d1 (mm)	Code	Weight (kg)	d2 (mm)	D (mm)	L (mm)	L1 (mm)	h (mm)	H (mm)	SDR pipe
450	315	193 135 436	18.500	232	500	500	157	216	346	11 - 26
500	315	193 135 446	17.000	232	500	500	157	216	337	11 - 26
560	315	193 135 456	16.100	232	500	500	157	216	327	11 - 26
630	315	193 135 466	15.950	232	500	500	157	216	312	11 - 33
710	315	193 135 476	14.800	232	500	500	157	216	297	11 - 33
800	315	193 135 486	14.300	232	500	500	157	216	287	11 - 33
900	315	193 135 496	13.800	232	500	500	157	216	281	11 - 33
1000	315	193 135 506	13.500	232	500	500	157	216	274	11 - 33



**Branch saddle topload
outlet 315 - 500 mm**

- PE 100 SDR 17 (ISO S8)
- 5 bar Gas / 10 bar Water
- Angle adaptors (799.350.340) for fusion cable required
- Branch saddle installation only with installation set Topload TL500 (799.300.809)
- 4 mm pin connectors
- Spigot outlet for butt- and electrofusion
- Full pressure applicable - no derating factor

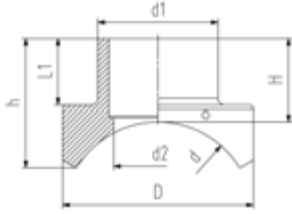

d (mm)	d1 (mm)	Code	Weight (kg)	d2 (mm)	D (mm)	L (mm)	L1 (mm)	h (mm)	H (mm)	SDR pipe
710	315	193 135 676	14.000	250	500	500	157	174	266	11 - 33
800	315	193 135 686	13.500	250	500	500	157	174	261	11 - 33
900	315	193 135 696	13.100	250	500	500	157	174	251	11 - 33
900	500	193 135 698	32.600	397	700	700	219	237	406	11 - 33
1000	315	193 135 706	12.800	250	500	500	157	174	246	11 - 33
1000	500	193 135 708	31.400	397	700	700	219	237	396	11 - 33
1200	315	193 135 716	12.300	250	500	500	157	174	241	11 - 33
1200	500	193 135 718	29.400	397	700	700	219	237	378	11 - 33
1400	315	193 135 726	11.900	250	500	500	157	174	234	11 - 33
1400	500	193 135 728	28.100	397	700	700	219	237	363	11 - 33
1600	315	193 135 736	11.700	250	500	500	157	174	228	11 - 33
1600	500	193 135 738	27.100	397	700	700	219	237	352	11 - 33
2000	315	193 135 746	11.300	250	500	500	157	174	221	11 - 33
2000	500	193 135 748	25.700	397	700	700	219	237	337	11 - 33

Accessories & tools



Pressure Test Cap

- Enables pressure testing of branch saddles ELGEF Plus after fusion and before tapping the main pipe
- Suitable for branch saddle with spigot outlet (193435402- 748 and 193135202- 304)
- Recommended maximum test pressure at +20°C according DVS 2210-1 = 18 bar water (SDR11) / 11 bar water (SDR 17)
- Recommended test duration = 60 minutes
- Connecting thread for pressure test is female thread G 3/8"

d (mm)	Code	description	L (mm)	B (mm)	H (mm)
160 - 225	799 199 287	Suitable for branch saddle with spigot outlet d160 and d225mm and Tapping saddles Monobloc main dimension d63-160mm; Material: Aluminum; Scope of delivery: 1 x Pressure test cap, 1 x O-ring 25.07 x 2.62	26	36	39
315	799 199 288	Suitable for branch saddle with spigot outlet d315mm; Scope of delivery: 1 x pressure test cap, 1 x O-Ring, 1 x GEKA-plus hose nipple, 1 x GEKA-plus transition female thread G3/8", 1 x Transport box	310	310	320
500	799 199 289	Suitable for branch saddle with spigot outlet d500mm; Scope of delivery: 1 x pressure test cap, 1 x O-Ring, 1 x GEKA-plus hose nipple, 1 x GEKA-plus transition female thread G3/8", 1 x Transport box	465	465	400



Accessories / single parts for Pressure test cap





- Suitable for Pressure test cap

Code	description	L (mm)	B (mm)	H (mm)
799 199 321	1 x O-Ring for 799199288 d315	222	222	7
799 199 322	1 x O-Ring for 799199289 d500	380	380	7
799 199 323	1 x GEKA-plus transition female thread G 3/8"	55	55	35
799 199 327	1 x Transport box for 799199288 d315	310	310	320
799 199 328	1 x Transport box for 799199289 d500	465	465	400

ELGEF Plus spigot fittings

Spigot fittings for electrofusion and butt fusion

Page

	Elbows	65
	Bends	69
	Tees	76
	Reducers	84
	End caps	87



Elbows

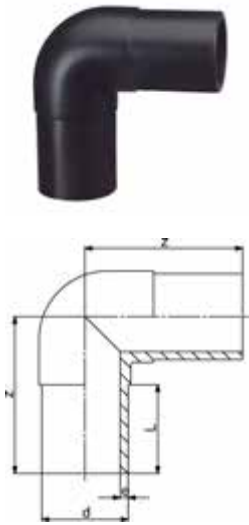

Elbow 90° PE 100 SDR11

- Long spigot version
- 10 bar Gas / 16 bar Water

d (mm)	Code	Weight (kg)	z (mm)	L (mm)	e (mm)
20	753 101 006	0.027	75	52	3.0
25	753 101 007	0.040	80	52	3.0
32	753 101 008	0.056	85	54	3.0
40	753 101 009	0.089	95	57	3.7
50	753 101 010	0.156	105	63	4.6
63	753 101 011	0.274	115	65	5.8
75	753 101 012	0.414	130	72	6.8
90	753 101 013	0.704	150	81	8.2
110	753 101 014	1.158	165	86	10.0
125	753 101 015	1.609	180	92	11.4
140	753 101 016	2.270	194	92	12.7
160	753 101 017	3.100	210	102	14.6
180	753 101 018	4.328	232	107	16.4
200	753 101 019	5.739	253	117	18.2
225	753 101 020	7.775	270	122	20.5
250	753 101 001	10.506	292	130	22.7
280	753 100 922	15.059	320	140	25.4
315	753 100 923	21.960	370	150	28.6

Elbow 90° PE100 SDR17/17,6

- Long spigot version
- 5 bar Gas / 10 bar Water

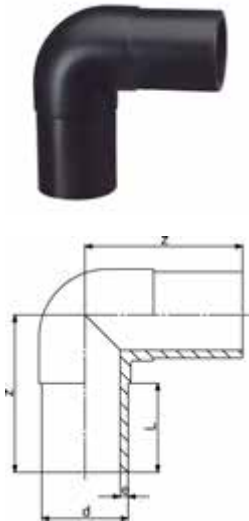

d (mm)	Code	Weight (kg)	z (mm)	L (mm)	e (mm)
90	753 100 813	0.543	150	81	5.4
110	753 100 814	0.876	165	86	6.6
125	753 100 815	0.927	180	93	7.4
140	753 100 816	1.547	194	92	8.3
160	753 100 817	2.385	210	102	9.5
180	753 100 818	3.205	232	107	10.7
200	753 100 819	4.298	253	115	11.9
225	753 100 820	5.864	270	120	13.4
250	753 100 821	7.700	292	130	14.8
280	753 100 822	11.328	320	140	16.6
315	753 100 823	15.300	370	150	18.7

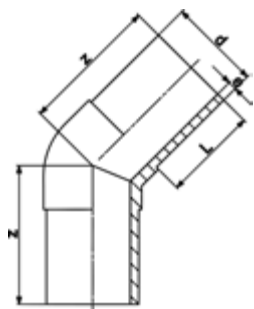

Elbow 45° PE100 SDR11

- Long spigot version
- 10 bar Gas / 16 bar Water

d (mm)	Code	Weight (kg)	z (mm)	L (mm)	e (mm)
20	753 151 006	0.027	70	52	3.0
25	753 151 007	0.037	75	52	3.0
32	753 151 008	0.050	80	54	3.0
40	753 151 009	0.086	85	57	3.7
50	753 151 010	0.133	90	63	4.6
63	753 151 011	0.227	95	65	5.8
75	753 151 012	0.350	105	72	6.8
90	753 151 013	0.565	120	81	8.2
110	753 151 014	0.921	130	86	10.0
125	753 151 015	1.290	140	92	11.4
140	753 151 016	1.796	164	120	12.7
160	753 151 017	2.454	162	102	14.6
180	753 151 018	3.274	170	107	16.4
200	753 151 019	4.362	186	116	18.2
225	753 151 020	5.981	200	123	20.5
250	753 151 021	8.283	220	130	22.7
280	753 150 922	10.285	230	140	25.4
315	753 150 923	14.124	250	150	28.6

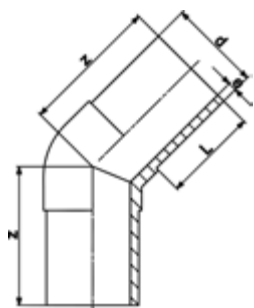

Elbow 45° PE100 SDR17/17,6

- 5 bar Gas / 10 bar Water
- Long spigot version

d (mm)	Code	Weight (kg)	z (mm)	L (mm)	e (mm)
90	753 150 813	0.411	120	81	5.4
110	753 150 814	0.686	130	86	6.6
125	753 150 815	0.948	140	92	7.4
140	753 150 816	1.259	164	120	8.3
160	753 150 817	1.901	162	102	9.5
180	753 150 818	2.386	170	107	10.7
200	753 150 819	3.153	186	116	11.9
225	753 150 820	4.441	205	123	13.4
250	753 150 821	6.012	217	130	14.8
280	753 150 822	7.489	230	140	16.6
315	753 150 823	10.123	250	150	18.7

Elbow 30° PE100 SDR11

- Long spigot version
- 10 bar Gas / 16 bar Water
- Welded design



d (mm)	Code	Weight (kg)	z (mm)	L (mm)	e (mm)
32	753 120 908	0.530	70	54	3.0
40	753 120 909	0.530	80	57	3.7
50	753 120 910	0.121	80	63	4.6
63	753 120 911	0.207	80	65	5.8
75	753 120 912	0.311	90	72	6.8
90	753 120 913	0.510	100	81	8.2
110	753 120 914	0.840	105	86	10.0
125	753 120 915	1.174	115	92	11.4
140	753 120 916	1.760	135	92	12.7
160	753 120 917	2.155	130	102	14.6
180	753 120 918	2.911	140	107	16.4
200	753 120 919	3.892	150	116	18.2
225	753 120 920	5.332	165	123	20.5
250	753 120 921	7.307	190	130	22.7
280	753 120 922	10.600	200	139	25.4
315	753 120 923	12.775	200	150	28.6

Elbow 30° PE100 SDR17/17,6

- Long spigot version
- 5 bar Gas / 10 bar Water
- Welded design



d (mm)	Code	Weight (kg)	z (mm)	L (mm)	e (mm)
90	753 120 813	0.363	110	81	5.4
110	753 120 814	0.607	115	86	6.6
125	753 120 815	0.819	125	92	7.4
140	753 120 816	1.112	150	92	8.3
160	753 120 817	1.526	140	102	9.5
180	753 120 818	2.040	150	107	10.7
200	753 120 819	2.780	160	116	11.9
225	753 120 820	3.798	180	123	13.4
250	753 120 821	5.039	200	130	14.8
280	753 120 822	8.100	200	139	16.6
315	753 120 823	8.655	220	150	18.7

Elbow 15° type L PE100 SDR11

- Long spigot version
- 10 bar Gas / 16 bar Water
- Welded design

d (mm)	Code	Weight (kg)	z (mm)	L (mm)	e (mm)
32	753 141 008	0.051	70	54	3
40	753 141 009	0.082	80	57	4
50	753 141 010	0.118	80	63	5
63	753 141 011	0.200	80	65	6
75	753 141 012	0.290	90	72	7
90	753 141 013	0.479	100	81	8
110	753 141 014	0.785	105	86	10
125	753 141 015	1.063	115	92	11
140	753 141 016	1.600	135	92	13
160	753 141 017	2.170	130	102	15
180	753 141 018	2.653	140	107	16
200	753 141 019	3.438	150	116	18
225	753 141 020	4.765	165	123	21
250	753 141 021	8.300	190	130	23
280	753 141 022	8.322	200	139	25
315	753 141 023	11.292	200	150	29

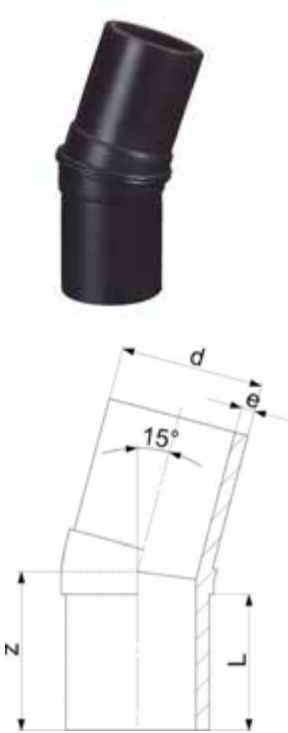

Elbow 15° PE100 SDR17/17,6

- Long spigot version
- 5 bar Gas / 10 bar Water
- Welded design

d (mm)	Code	Weight (kg)	z (mm)	L (mm)	e (mm)
90	753 140 813	0.337	100	81	5
110	753 140 814	0.551	105	86	7
125	753 140 815	0.728	115	92	7
140	753 140 816	0.370	135	92	8
160	753 140 817	1.364	130	102	10
180	753 140 818	2.040	140	107	11
200	753 140 819	2.371	150	116	12
225	753 140 820	3.335	165	123	13
250	753 140 821	5.830	190	130	15
280	753 140 822	8.100	195	139	17
315	753 140 823	7.528	200	150	19



Bends

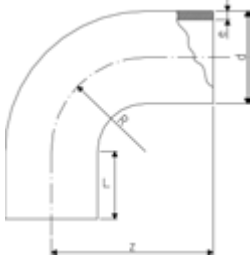

Bend 90° PE100 SDR11

- Long spigot version
- 10 bar Gas / 16 bar Water
- * Made out of seamless pipe. This shall not be shortened.

d (mm)	Code	Weight (kg)	z (mm)	L (mm)	R (mm)	e (mm)	
32	753 001 008	0.042	78	46	32	2.9	
40	753 001 009	0.090	91	49	40	3.7	
50	753 001 010	0.160	107	55	50	4.6	
63	753 001 011	0.280	130	63	63	5.8	
75	753 001 012	0.464	152	70	75	6.8	
90	753 001 013	0.530	168	79	90	8.2	
110	753 001 014	1.282	193	82	110	10.0	
125	753 001 015	1.290	216	87	125	11.4	
140	753 001 016	2.230	232	92	140	12.7	
160	753 001 017	3.424	258	98	160	14.6	
180	753 001 018	5.000	290	105	180	16.4	
200	753 001 019	6.925	317	112	200	18.2	
225	753 001 020	9.770	350	120	225	20.5	
250	753 001 021	9.230	375	130	250	22.7	
280	753 001 022	15.487	430	150	280	25.4	
315	753 001 023	23.950	470	150	315	28.6	
*	355	753 001 024	53.300	900	250	533	32.3
*	400	753 001 025	71.900	980	250	600	36.4
*	450	753 001 026	97.300	1070	250	675	40.9
*	500	753 001 027	134.000	1200	280	750	45.5
*	560	753 001 028	179.300	1290	280	840	50.9
*	630	753 001 029	243.200	1400	280	945	57.3
*	710	753 001 030	469.943	2200	570	1630	64.5
*	800	753 001 031	577.131	2200	480	1720	72.6

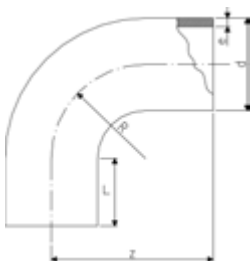

Bend 90° PE100 SDR17

- Long spigot version
- 5 bar Gas / 10 bar Water
- * Made out of seamless pipe. This shall not be shortened.

d (mm)	Code	Weight (kg)	L (mm)	R (mm)	z (mm)	e (mm)	
90	753 000 813	0.520	79	90	168	5.4	
110	753 000 814	0.942	82	110	193	6.6	
125	753 000 815	1.300	87	125	216	7.4	
140	753 000 816	1.789	92	140	232	8.3	
160	753 000 817	2.410	98	160	258	9.5	
180	753 000 818	4.000	105	180	290	10.7	
200	753 000 819	6.500	112	200	317	11.9	
225	753 000 820	6.414	120	225	350	13.4	
250	753 000 821	9.940	130	250	375	14.8	
280	753 000 822	13.795	150	280	430	16.6	
315	753 000 823	24.000	150	315	470	18.7	
*	355	753 000 824	36.700	250	533	900	21.1
*	400	753 000 825	49.700	250	600	980	23.7
*	450	753 000 826	66.600	250	675	1070	26.7
*	500	753 000 827	87.400	280	750	1200	29.7
*	560	753 000 828	116.000	280	840	1290	33.2
*	630	753 000 829	159.600	280	945	1400	37.4
*	710	753 000 830	317.382	570	1630	2200	42.1
*	800	753 000 831	389.859	480	1720	2200	47.4

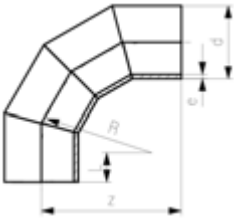

Bend 90° PE100 SDR17

Model:

- Conventional butt-welding according to DVS 2207
- Production process: segment welded
- Segment-welded fittings have a pressure reduction factor of 0.8
- 8 bar water
- Long spigot version

d (mm)	Code	Weight (kg)	z (mm)	L (mm)	R (mm)	e (mm)
710	753 002 001	202.419	1415	350	1065	42.1
800	753 002 002	279.918	1550	350	1200	47.4
900	753 002 003	386.595	1700	350	1350	53.3
1000	753 002 004	534.660	1900	400	1500	59.3

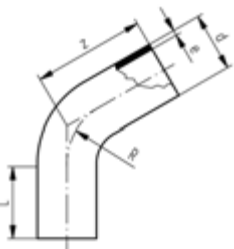

Bend 60° PE100 SDR11

- Made out of seamless pipe
- Long spigot version
- 10 bar Gas / 16 bar Water
- Bends made out of seamless pipe shall not be shortened

d (mm)	Code	Weight (kg)	R (mm)	L (mm)	z (mm)	e (mm)
32	753 071 008	0.070	48	80	128	2.9
40	753 071 009	0.120	60	80	135	3.7
50	753 071 010	0.240	75	100	158	4.6
63	753 071 011	0.420	95	100	173	5.8
75	753 071 012	0.600	113	100	182	6.8
90	753 071 013	0.900	135	100	193	8.2
110	753 071 014	1.780	165	150	270	10.0
125	753 071 015	2.500	188	150	283	11.4
140	753 071 016	2.700	210	150	296	12.7
160	753 071 017	4.574	240	150	313	14.6
180	753 071 018	4.900	270	150	330	16.4
200	753 071 019	6.400	300	150	348	18.2
225	753 071 020	8.600	338	150	370	20.5
250	753 071 021	14.500	375	250	500	22.7
280	753 071 022	19.100	420	250	530	25.4
315	753 071 023	25.600	473	250	612	28.6
355	753 071 024	41.700	533	300	690	32.3
400	753 071 025	55.800	600	300	730	36.4
450	753 071 026	76.000	675	300	780	40.9
500	753 071 027	104.600	750	350	880	45.5
560	753 071 028	139.500	840	350	930	50.9
630	753 071 029	188.500	945	350	1000	57.3



Bend 60° PE100 SDR17/17,6

- Long spigot version
- 5 bar Gas / 10 bar Water
- Made out of seamless pipe
- Bends made out of seamless pipe shall not be shortened

d (mm)	Code	Weight (kg)	e (mm)	R (mm)	z (mm)	L (mm)
90	753 070 813	0.600	5.4	135	193	100
110	753 070 814	1.280	6.6	165	270	150
125	753 070 815	1.300	7.4	187	283	150
140	753 070 816	1.800	8.3	210	296	150
160	753 070 817	3.160	9.5	240	313	150
180	753 070 818	3.190	10.7	270	330	150
200	753 070 819	4.200	11.9	300	348	150
225	753 070 820	5.600	13.4	337	370	150
250	753 070 821	9.250	14.8	375	500	250
280	753 070 822	15.000	16.6	420	530	250
315	753 070 823	19.500	18.7	472	612	250
355	753 070 824	30.100	21.1	532	690	300
400	753 070 825	38.200	23.7	600	730	300
450	753 070 826	53.700	26.7	675	780	300
500	753 070 827	73.900	29.7	750	880	350
560	753 070 828	98.200	33.2	840	930	350
630	753 070 829	132.300	37.4	945	1000	350

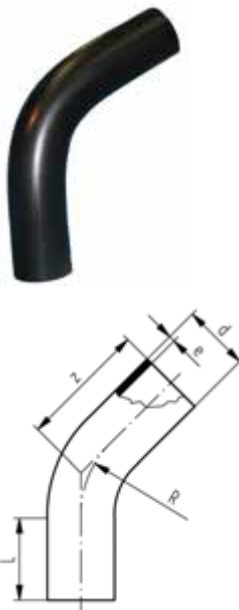

Bend 45° PE100 SDR11

- Long spigot version
- 10 bar Gas / 16 bar Water
- Made out of seamless pipe
- Bends made out of seamless pipe shall not be shortened

d (mm)	Code	Weight (kg)	e (mm)	z (mm)	R (mm)	L (mm)
32	753 051 008	0.077	2.9	120	48	80
40	753 051 009	0.120	3.7	120	60	80
50	753 051 010	0.240	4.6	149	75	100
63	753 051 011	0.360	5.8	161	95	100
75	753 051 012	0.560	6.8	168	113	100
90	753 051 013	0.760	8.2	177	135	100
110	753 051 014	1.700	10.0	243	165	150
125	753 051 015	2.186	11.4	253	188	150
140	753 051 016	2.800	12.7	262	210	150
160	753 051 017	3.800	14.6	274	240	160
180	753 051 018	5.140	16.4	287	270	150
200	753 051 019	7.058	18.2	299	300	150
225	753 051 020	7.400	20.5	315	338	150
250	753 051 021	13.000	22.7	440	375	250
280	753 051 022	22.000	25.4	460	420	250
315	753 051 023	24.930	28.6	535	473	250
355	753 051 024	39.500	32.3	620	533	300
400	753 051 025	48.500	36.4	650	600	300
450	753 051 026	69.800	40.9	680	675	300
500	753 051 027	96.300	45.5	760	750	350
560	753 051 028	129.800	50.9	800	840	350
630	753 051 029	174.000	57.3	870	945	350



Bend 45° PE100 SDR17/17,6

Model:

- Conventional butt-welding according to DVS 2207
- Production process: segment welded
- Segment-welded fittings have a pressure reduction factor of 0.8
- 8 bar water
- Long spigot version

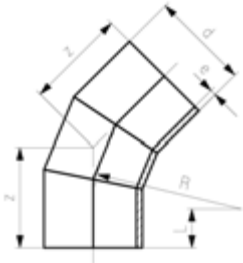

d (mm)	Code	Weight (kg)	z (mm)	L (mm)	R (mm)	e (mm)
710	753 003 001	129.998	792	350	1065	42.1
800	753 003 002	176.165	847	350	1200	47.4
900	753 003 003	252.638	960	350	1350	53.3
1000	753 003 004	332.107	1022	400	1500	59.3



Bend 45° PE100 SDR17/17,6

- Long spigot version
- 5 bar Gas / 10 bar Water
- Made out of seamless pipe
- Bends made out of seamless pipe shall not be shortened

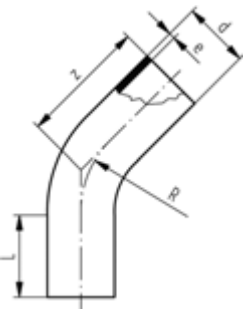

d (mm)	Code	Weight (kg)	R (mm)	e (mm)	z (mm)	L (mm)
90	753 050 813	0.600	135	5.4	177	100
110	753 050 814	1.208	165	6.6	243	150
125	753 050 815	1.540	188	7.4	253	150
140	753 050 816	1.720	210	8.3	262	150
160	753 050 817	2.200	240	9.5	274	150
180	753 050 818	3.000	270	10.7	287	150
200	753 050 819	3.700	300	11.9	299	150
225	753 050 820	5.000	338	13.4	315	150
250	753 050 821	10.691	375	14.8	440	250
280	753 050 822	15.000	420	16.6	460	250
315	753 050 823	17.800	473	18.7	535	250
355	753 050 824	25.600	533	21.1	620	300
400	753 050 825	36.600	600	23.7	650	300
450	753 050 826	45.300	675	26.7	680	300
500	753 050 827	62.400	750	29.7	760	350
560	753 050 828	81.900	840	33.2	800	350
630	753 050 829	197.000	945	37.4	870	350

Bend 30° PE100 SDR11



- Long spigot version
- 10 bar Gas / 16 bar Water
- Made out of seamless pipe
- Bends made out of seamless pipe shall not be shortened

d (mm)	Code	Weight (kg)	L (mm)	z (mm)	e (mm)	R (mm)
32	753 061 008	0.077	80	113	2.9	48
40	753 061 009	0.120	80	116	3.7	60
50	753 061 010	0.200	100	140	4.6	75
63	753 061 011	0.400	100	150	5.8	95
75	753 061 012	0.520	100	155	6.8	113
90	753 061 013	0.760	100	160	8.2	135
110	753 061 014	1.689	150	219	10.0	165
125	753 061 015	2.096	150	225	11.4	188
140	753 061 016	2.200	150	231	12.7	210
160	753 061 017	3.650	150	239	14.6	240
180	753 061 018	4.782	150	247	16.4	270
200	753 061 019	5.777	150	255	18.2	300
225	753 061 020	6.300	150	266	20.5	338
250	753 061 021	13.100	250	385	22.7	375
280	753 061 022	16.300	250	400	25.4	420
315	753 061 023	21.850	250	460	28.6	473
355	753 061 024	34.900	300	540	32.3	533
400	753 061 025	45.900	300	560	36.4	600
450	753 061 026	60.200	300	580	40.9	675
500	753 061 027	83.300	350	630	45.5	750
560	753 061 028	108.600	350	680	50.9	840
630	753 061 029	148.300	350	730	57.3	945

Bend 30° PE100 SDR17/17,6



- Long spigot version
- 5 bar Gas / 10 bar Water
- Made out of seamless pipe
- Bends made out of seamless pipe shall not be shortened

d (mm)	Code	Weight (kg)	z (mm)	L (mm)	R (mm)	e (mm)
90	753 060 813	0.500	160	100	135	5.4
110	753 060 814	1.060	219	150	165	6.6
125	753 060 815	1.100	225	150	188	7.4
140	753 060 816	1.720	231	150	210	8.3
160	753 060 817	2.565	239	150	240	9.5
180	753 060 818	3.389	247	150	270	10.7
200	753 060 819	4.213	255	150	300	11.9
225	753 060 820	7.540	266	150	338	13.4
250	753 060 821	11.600	385	250	375	14.8
280	753 060 822	12.800	400	250	420	16.6
315	753 060 823	25.000	460	250	473	18.7
355	753 060 824	22.700	540	300	533	21.1
400	753 060 825	29.800	560	300	600	23.7
450	753 060 826	39.100	580	300	675	26.7
500	753 060 827	54.000	650	350	750	29.7
560	753 060 828	70.300	680	350	840	33.2
630	753 060 829	95.800	730	350	945	37.4

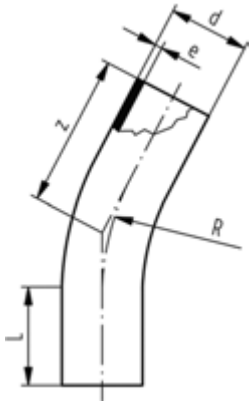

Bend 22° PE100 SDR11

- Long spigot version
- 10 bar Gas / 16 bar Water
- Made out of seamless pipe
- Bends made out of seamless pipe shall not be shortened

d (mm)	Code	Weight (kg)	z (mm)	L (mm)	R (mm)	e (mm)
32	753 081 008	0.077	113	80	48	2.9
40	753 081 009	0.120	116	80	60	3.7
50	753 081 010	0.200	140	100	75	4.6
63	753 081 011	0.400	150	100	95	5.8
75	753 081 012	0.520	155	100	113	6.8
90	753 081 013	0.760	160	100	135	8.2
110	753 081 014	1.500	219	150	165	10.0
125	753 081 015	2.000	225	150	188	11.4
140	753 081 016	2.200	231	150	210	12.7
160	753 081 017	3.300	239	150	240	14.6
180	753 081 018	3.700	247	150	270	16.4
200	753 081 019	4.750	255	150	300	18.2
225	753 081 020	6.300	266	150	338	20.5
250	753 081 021	14.015	385	250	375	22.7
280	753 081 022	18.510	400	250	420	25.4
315	753 081 023	21.845	460	250	473	28.6
355	753 081 024	34.900	540	300	533	32.3
400	753 081 025	45.900	560	300	600	36.4
450	753 081 026	60.200	580	300	675	40.9
500	753 081 027	83.300	650	350	750	45.5
560	753 081 028	108.600	680	350	840	50.9
630	753 081 029	148.300	730	350	945	57.3

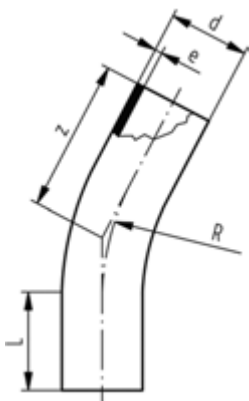

Bend 22° PE100 SDR17/17,6

- Long spigot version
- 5 bar Gas / 10 bar Water
- Made out of seamless pipe
- Bends made out of seamless pipe shall not be shortened

d (mm)	Code	Weight (kg)	R (mm)	e (mm)	z (mm)	L (mm)
90	753 080 813	0.500	135	5	160	100
110	753 080 814	1.060	165	7	219	150
125	753 080 815	1.100	188	7	225	150
140	753 080 816	1.720	210	8	231	150
160	753 080 817	1.900	240	10	239	150
180	753 080 818	3.318	270	11	247	150
200	753 080 819	3.200	300	12	255	150
225	753 080 820	5.431	338	13	266	150
250	753 080 821	9.904	375	15	385	250
280	753 080 822	12.800	420	17	400	250
315	753 080 823	14.144	473	19	460	250
355	753 080 824	22.700	533	21	540	300
400	753 080 825	29.800	600	24	560	300
450	753 080 826	39.100	675	27	580	300
500	753 080 827	54.000	750	30	650	350
560	753 080 828	70.300	840	33	680	350
630	753 080 829	95.800	945	37	730	350

Bend 11° PE100 SDR11



- Long spigot version
- 10 bar Gas / 16 bar Water
- Made out of seamless pipe
- Bends made out of seamless pipe shall not be shortened

d (mm)	Code	Weight (kg)	L (mm)	e (mm)	z (mm)	R (mm)
32	753 091 008	0.077	80	3	113	48
40	753 091 009	0.120	80	4	116	60
50	753 091 010	0.200	100	5	140	75
63	753 091 011	0.400	100	6	150	95
75	753 091 012	0.520	100	7	155	113
90	753 091 013	0.760	100	8	160	135
110	753 091 014	1.500	150	10	219	165
125	753 091 015	2.000	150	11	225	188
140	753 091 016	2.200	150	13	231	210
160	753 091 017	3.300	150	15	239	240
180	753 091 018	3.700	150	16	247	270
200	753 091 019	4.750	150	18	255	300
225	753 091 020	7.773	150	21	266	338
250	753 091 021	13.100	250	23	385	375
280	753 091 022	16.300	250	25	400	420
315	753 091 023	21.845	250	29	460	473
355	753 091 024	34.900	300	32	540	533
400	753 091 025	45.900	300	36	560	600
450	753 091 026	60.200	300	41	580	675
500	753 091 027	83.300	350	46	650	750
560	753 091 028	108.600	350	51	680	840
630	753 091 029	148.300	350	57	730	945

Bend 11° PE100 SDR17/17,6



- Long spigot version
- 5 bar Gas / 10 bar Water
- Made out of seamless pipe
- Bends made out of seamless pipe shall not be shortened

d (mm)	Code	Weight (kg)	z (mm)	L (mm)	R (mm)	e (mm)
90	753 090 813	0.500	160	100	135	5
110	753 090 814	1.060	219	150	165	7
125	753 090 815	1.100	225	150	188	7
140	753 090 816	1.720	231	150	210	8
160	753 090 817	2.653	239	150	240	10
180	753 090 818	2.500	247	150	270	11
200	753 090 819	4.308	255	150	300	12
225	753 090 820	7.540	266	150	338	13
250	753 090 821	11.600	385	250	375	15
280	753 090 822	12.800	400	250	420	17
315	753 090 823	25.000	460	250	473	19
355	753 090 824	22.700	540	300	533	21
400	753 090 825	29.800	560	300	600	24
450	753 090 826	39.100	580	300	675	27
500	753 090 827	54.000	650	350	750	30
560	753 090 828	70.300	680	350	840	33
630	753 090 829	95.800	730	350	945	37

Tees



Tee 90° equal PE100 SDR11

- Long spigot version
- 10 bar Gas / 16 bar Water
- * Segment welded and reinforced
- ** Machined with welded pipes

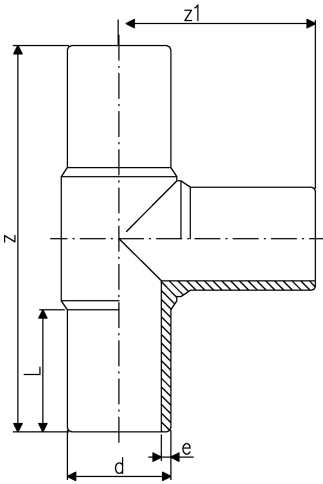

d (mm)	Code	Weight (kg)	z (mm)	z1 (mm)	L (mm)	e (mm)	
20	753 201 006	0.038	150	75	52	3.0	
25	753 201 007	0.054	160	80	52	3.0	
32	753 201 008	0.077	170	85	54	3.0	
40	753 201 009	0.130	190	95	57	3.7	
50	753 201 010	0.214	210	105	63	4.6	
63	753 201 011	0.376	230	115	65	5.8	
75	753 201 012	0.599	264	132	72	6.8	
90	753 201 013	1.021	300	150	81	8.2	
110	753 201 014	1.612	330	165	86	10.0	
125	753 201 015	2.420	366	183	92	11.4	
140	753 201 016	3.090	393	193	92	12.7	
160	753 201 017	4.403	420	210	102	14.6	
180	753 201 018	6.014	460	230	107	16.4	
200	753 201 019	8.480	500	250	117	18.2	
225	753 201 020	11.507	540	270	122	20.5	
250	753 201 001	14.099	575	288	130	22.7	
280	753 200 902	18.670	615	308	139	25.4	
315	753 200 903	26.150	695	346	150	28.6	
355	753 200 024	38.900	820	410	170	32.3	
400	753 200 025	53.400	900	450	190	36.4	
450	753 200 026	73.400	980	490	200	40.9	
500	753 200 027	98.500	1070	535	220	45.5	
*	560	753 200 908	153.300	1510	755	230	50.9
*	630	753 200 909	205.500	1630	815	250	57.3
**	710	753 201 120	318.698	1720	860	450	64.5
**	800	753 201 121	409.142	1780	890	450	72.6



Tee 90° equal PE100 SDR17/17,6

- Long spigot version
- 5 bar Gas / 10 bar Water
- * Segment welded and reinforced
- ** Machined with welded pipes

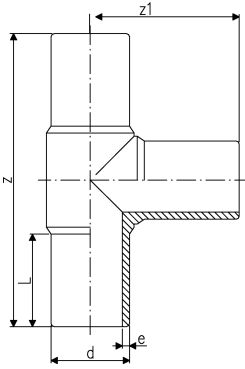

d (mm)	Code	Weight (kg)	z (mm)	z1 (mm)	L (mm)	e (mm)	
90	753 200 813	0.777	300	150	80	5.4	
110	753 200 814	1.231	330	165	86	6.6	
125	753 200 815	1.690	366	183	92	7.4	
140	753 200 816	2.202	396	196	92	8.3	
160	753 200 817	3.201	428	214	104	9.5	
180	753 200 818	4.287	460	230	105	10.7	
200	753 200 819	5.889	500	250	115	11.9	
225	753 200 820	7.886	540	270	122	13.4	
250	753 200 821	10.000	575	288	130	14.8	
280	753 200 802	13.350	615	308	139	16.6	
315	753 200 803	17.985	695	346	150	18.7	
355	753 200 124	26.100	820	410	170	21.1	
400	753 200 125	35.700	900	450	190	23.7	
450	753 200 126	49.400	980	490	200	26.7	
500	753 200 127	66.100	1070	535	220	29.7	
*	560	753 200 808	99.200	1510	755	230	33.2
*	630	753 200 809	132.700	1630	815	250	37.4
*	710	753 201 920	223.440	1720	860	430	42.1
*	800	753 201 921	289.460	1780	890	415	47.4



Tee 90° equal PE100 SDR17/17,6

Model:

- Conventional butt-welding according to DVS 2207
- Production process: segment welded
- Does not conform to pressure rating. Pressure reduction factor of 0.5
- 5 bar water
- Long spigot version

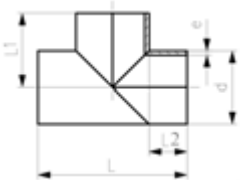

d (mm)	Code	Weight (kg)	L (mm)	L1 (mm)	L2 (mm)	e (mm)
710	753 202 810	158.180	1410	705	350	42.1
800	753 202 811	210.302	1500	750	350	47.4
900	753 202 812	302.118	1700	850	400	53.3
1000	753 202 813	457.054	2040	1020	520	59.3



Tee 45° equal PE100 SDR11

- Long spigot version

d (mm)	Code	Weight (kg)	z (mm)	z1 (mm)	L (mm)	e (mm)
50	753 251 010	0.300	218	139	56	4.6
63	753 251 011	0.440	255	158	63	6.2
75	753 251 012	0.800	301	190	70	6.8
90	753 251 013	1.373	368	234	79	8.2
110	753 251 014	1.800	395	260	82	10.0



Tee 45° equal PE100 SDR17/17,6

- 5 bar Gas / 10 bar Water
- Long spigot version

d (mm)	Code	Weight (kg)	z (mm)	z1 (mm)	L (mm)	e (mm)
90	753 251 063	0.800	368	234	79	5.4
110	753 251 064	1.400	395	260	82	6.6



Tee 90° reduced PE100 SDR11

Model:

- moulded
- 10 bar Gas / 16 bar Water
- Long spigot version

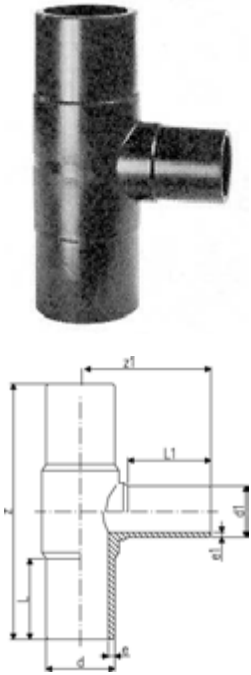

d (mm)	d1 (mm)	Code	Weight (kg)	z (mm)	z1 (mm)	L (mm)	L1 (mm)	e (mm)	e1 (mm)
63	32	753 201 022	0.300	218	86	65	47	5.8	3.0
63	40	753 201 026	0.312	230	107	67	58	5.8	3.7
63	50	753 201 021	0.300	218	100	65	59	5.8	4.6
75	32	753 201 023	0.455	248	98	73	46	6.8	3.0
75	50	753 201 024	0.485	248	109	73	58	6.8	4.6
75	63	753 201 025	0.520	248	118	73	65	6.8	5.8
90	50	753 201 027	0.794	280	120	79	55	8.2	4.6
90	63	753 201 029	0.775	282	127	79	63	8.2	5.8
90	75	753 201 055	0.800	286	132	80	75	8.2	6.8
110	63	753 201 028	1.409	322	148	87	63	10.0	5.8
110	75	753 201 031	1.221	305	148	83	68	10.0	6.8
110	90	753 201 032	1.275	322	164	86	79	10.0	8.2
125	90	753 201 048	1.717	332	168	109	89	11.4	8.2
125	110	753 201 033	1.909	340	167	90	83	11.4	10.0
160	63	753 201 034	2.680	416	174	105	65	14.6	5.8
160	75	753 201 035	2.676	344	179	101	76	14.6	6.8
160	90	753 201 036	2.775	415	190	101	79	14.6	8.2
160	110	753 201 037	3.300	415	200	101	82	14.6	10.0
180	90	753 201 049	4.410	420	200	136	97	16.4	8.2
180	110	753 201 050	4.379	430	206	145	101	16.4	10.0
180	160	753 201 038	4.715	414	203	105	94	16.4	14.6
200	63	753 201 073	7.300	503	196	122	63	18.2	5.8
200	90	753 201 074	9.730	500	216	122	79	18.2	8.2
200	110	753 201 075	7.120	505	219	122	82	18.2	10.0
200	160	753 201 076	9.730	500	237	122	98	18.2	14.6
225	75	753 201 039	9.880	560	219	120	70	20.5	6.8
225	90	753 201 040	6.633	555	228	120	80	20.5	8.2
225	110	753 201 041	10.010	559	238	120	82	20.5	10.0
225	160	753 201 042	8.095	555	258	120	98	20.5	14.6
225	180	753 201 043	9.375	559	284	120	105	20.5	16.4
250	110	753 201 078	11.820	584	284	130	82	22.7	10.0
250	160	753 201 079	12.302	586	266	127	98	22.7	14.6
315	110	753 201 051	15.300	705	282	150	82	28.6	10.0
315	160	753 201 052	22.998	705	301	150	102	28.6	14.6
315	225	753 201 053	20.011	658	335	170	145	28.6	20.5
315	250	753 201 054	24.243	695	331	150	130	28.6	22.7

Tee 90° reduced PE100 SDR11



Model:

- with welded reducer
- 10 bar Gas / 16 bar Water
- Long spigot version

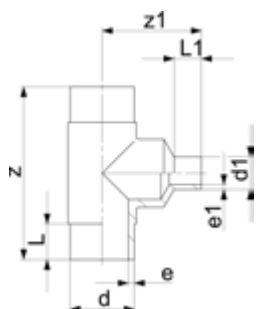

d (mm)	d1 (mm)	Code	Weight (kg)	z1 (mm)	z (mm)	L (mm)	L1 (mm)	e (mm)	e1 (mm)
25	20	753 201 002	0.053		160	52	52	3.0	3.0
32	20	753 201 003	0.094	105	170	54	52	3.0	3.0
32	25	753 201 004	0.098	110	170	54	52	3.0	3.0
40	20	753 201 005	0.124	120	190	57	52	3.7	3.0
40	25	753 201 069	0.160	120	190	57	52	3.7	3.0
40	32	753 201 070	0.160	120	190	57	52	3.7	3.0
50	20	753 201 072	0.252	140	210	63	52	4.6	3.0
50	25	753 201 077	0.203	130	210	63	52	4.6	3.0
50	32	753 201 080	0.207	130	210	63	53	4.6	3.0
50	40	753 201 081	0.224	130	210	63	57	4.6	3.7
75	40	753 201 084	0.603	180	264	72	57	6.8	3.7
125	63	753 201 085	2.359	225	366	92	61	11.4	5.8
125	75	753 201 086	2.434	235	366	92	72	11.4	6.8
140	75	753 201 087	3.038	230	396	92	70	12.7	6.8
140	90	753 201 089	3.092	235	396	92	79	12.7	8.2
140	110	753 201 090	3.208	240	396	92	82	12.7	10.0
140	125	753 201 091	4.170	240	396	92	90	12.7	11.4
160	125	753 201 092	4.544	265	420	102	92	14.6	11.4
160	140	753 201 093	5.895	270	420	102	96	14.6	12.7
180	125	753 201 094	6.111	285	460	107	92	16.4	11.4
180	140	753 201 095	6.317	295	460	107	110	16.4	12.7
200	125	753 201 096	8.424	295	500	117	92	18.2	11.4
200	140	753 201 097	10.570	310	500	117	110	18.2	12.7
200	180	753 201 098	9.031	310	500	117	110	18.2	16.4
225	125	753 201 099	11.260	320	540	122	92	20.5	11.4
225	140	753 201 100	14.574	335	540	122	110	20.5	12.7
225	200	753 201 101	14.925	340	540	122	117	20.5	18.2
250	180	753 201 102	14.327	350	576	130	105	22.7	16.4
250	200	753 201 103	19.220	360	576	130	112	22.7	18.2
250	225	753 201 104	15.240	390	576	130	120	22.7	20.5
280	200	753 201 105	24.520	420	616	139	112	25.4	18.2
280	225	753 201 106	21.755	420	616	139	120	25.4	20.5
280	250	753 201 107	21.055	420	616	139	130	25.4	22.7
315	200	753 201 108	33.672	470	690	150	134	28.6	18.2
315	280	753 201 109	34.950	480	690	150	139	28.6	25.4
355	250	753 201 110	48.900	530	818	165	130	32.3	22.7
355	280	753 201 111	49.300	480	818	165	139	32.3	25.4
355	315	753 201 112	49.690	480	818	165	150	32.3	28.6
400	280	753 201 113	52.915	530	910	180	139	36.4	25.4
400	315	753 201 114	53.625	580	910	180	150	36.4	28.6
400	355	753 201 115	54.075	675	910	180	165	36.4	32.3

Tee 90° reduced
PE100 SDR17/17.6

- moulded
- Long spigot version
- 5 bar Gas / 10 bar Water

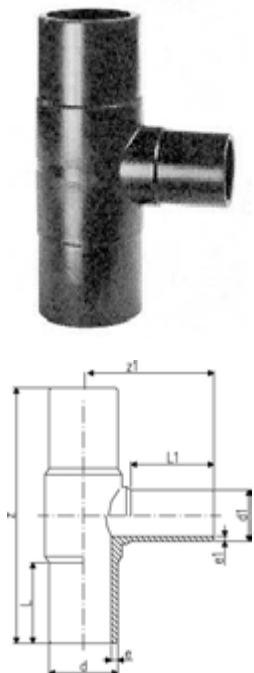

d	d1	Code	Weight	z	z1	L	L1	e	e1
(mm)	(mm)		(kg)	(mm)	(mm)	(mm)	(mm)	(mm)	(mm)
90	50	753 201 827	0.630	275	117	79	55	5.4	3.0
90	63	753 200 829	0.560	275	123	79	63	5.4	3.8
110	63	753 200 828	1.010	318	147	82	63	6.6	3.8
110	75	753 200 831	0.891	315	152	84	70	6.6	4.5
110	90	753 200 832	0.941	318	158	82	79	6.6	5.4
125	110	753 200 833	1.399	334	168	84	83	7.4	6.6
160	63	753 200 834	2.554	330	130	86	63	9.5	3.8
160	75	753 200 835	1.932	343	180	98	74	9.5	4.5
160	90	753 200 836	1.972	410	188	98	79	9.5	5.4
160	110	753 200 837	2.716	410	195	98	82	9.5	6.6
180	90	753 200 844	3.250	422	204	134	97	10.7	5.4
180	160	753 200 838	3.557	411	205	105	94	10.7	9.5
200	63	753 201 873	6.800	500	190	122	63	11.9	3.8
200	90	753 201 874	6.900	500	207	122	79	11.9	5.4
200	110	753 201 875	5.097	500	215	122	82	11.9	6.6
200	160	753 201 876	7.400	500	234	122	98	11.9	9.5
225	75	753 200 839	7.128	555	277	120	70	13.4	4.5
225	90	753 200 840	4.732	555	226	127	80	13.4	5.4
225	110	753 200 841	4.700	555	235	127	82	13.4	6.6
225	160	753 200 842	5.922	555	253	127	98	13.4	9.5
225	180	753 200 843	7.211	550	280	120	105	13.4	10.7
250	110	753 201 878	8.185	575	242	130	82	14.8	6.6
250	160	753 201 879	9.800	575	261	130	98	14.8	9.5
315	110	753 200 851	15.621	695	277	150	82	18.7	6.6
315	160	753 200 852	12.200	695	296	150	102	18.7	9.5
315	225	753 200 853	14.869	650	335	170	145	18.7	13.4
315	250	753 200 854	15.500	695	325	150	130	18.7	14.8

Tee 90° reduced PE100 SDR17/17.6



Model:

- with welded reducer
- 5 bar Gas / 10 bar Water
- Long spigot version

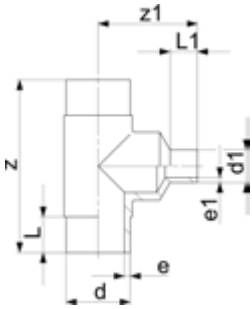

d (mm)	d1 (mm)	Code	Weight (kg)	z (mm)	z1 (mm)	L1 (mm)	L (mm)	e (mm)	e1 (mm)
125	63	753 200 801	1.752	366	215	61	92	7	4
125	75	753 200 810	1.806	366	235	72	92	7	5
125	90	753 200 811	1.712	366	235	80	92	7	5
140	75	753 200 812	2.820	396	240	70	92	8	5
140	90	753 200 822	2.211	396	240	78	92	8	5
140	110	753 200 823	2.266	396	235	82	92	8	7
140	125	753 200 824	2.317	396	240	87	92	8	7
160	125	753 200 825	3.311	428	265	90	104	10	5
160	140	753 200 826	3.416	428	280	96	104	10	8
180	110	753 200 827	4.410	460	285	92	105	11	7
180	125	753 200 845	4.460	460	285	90	105	11	7
180	140	753 200 846	4.483	460	305	110	105	11	8
200	125	753 200 847	5.886	500	310	92	115	12	7
200	140	753 200 848	7.200	500	315	110	115	12	8
200	180	753 200 849	6.900	500	315	110	115	12	11
225	125	753 200 850	7.937	540	320	92	122	13	7
225	140	753 200 855	8.780	540	345	110	122	13	8
225	200	753 200 856	9.064	540	335	115	122	13	12
250	180	753 200 857	15.000	576	340	105	130	15	11
250	200	753 200 858	15.440	576	350	112	130	15	12
250	225	753 200 859	15.620	576	370	120	130	15	13
280	200	753 200 860	19.200	616	400	112	139	17	12
280	225	753 200 861	19.500	616	400	120	139	17	13
280	250	753 200 862	20.120	616	400	130	139	17	15
315	200	753 200 863	18.700	690	480	134	150	19	12
315	280	753 200 864	26.940	690	480	139	150	19	17
355	250	753 200 865	35.770	818	480	130	165	21	15
355	280	753 200 866	36.330	818	480	139	165	21	17
355	315	753 200 867	37.740	818	490	150	165	21	19
400	280	753 200 868	48.330	910	540	139	180	24	17
400	315	753 200 869	48.880	910	580	150	180	24	19
400	355	753 200 870	50.020	910	675	165	180	24	21



T 45° reduced PE100 SDR11

Model:

- 10 bar Gas / 16 bar Water
- Long spigot version

d	d1	Code	Weight	z	z1	L	e
(mm)	(mm)		(kg)	(mm)	(mm)	(mm)	(mm)
63	50	753 251 044	0.219	252	142	65	5.8



Reducers

Reducer PE100 SDR11



- Long spigot version
- 10 bar Gas / 16 bar Water

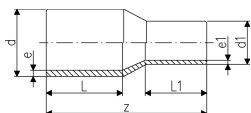

d (mm)	d1 (mm)	Code	Weight (kg)	z (mm)	L (mm)	L1 (mm)	e (mm)	e1 (mm)
25	20	753 901 038	0.022	115	53	52	3.0	3,0
32	20	753 901 042	0.027	122	55	53	3.0	3,0
32	25	753 901 041	0.033	122	55	53	3.0	3,0
40	20	753 901 048	0.043	127	56	50	3.7	3,0
40	25	753 901 047	0.045	128	55	50	3.7	3,0
40	32	753 901 046	0.047	128	55	52	3.7	3,0
50	20	753 901 055	0.064	147	62	50	4.6	3,0
50	25	753 901 054	0.069	139	62	50	4.6	3,0
50	32	753 901 053	0.067	140	62	54	4.6	3,0
50	40	753 901 052	0.079	138	62	55	4.6	3,7
63	32	753 901 060	0.113	150	65	53	5.8	3,0
63	40	753 901 059	0.122	150	65	57	5.8	3,7
63	50	753 901 058	0.128	150	65	62	5.8	4,6
75	40	753 901 063	0.185	170	72	51	6.8	3,7
75	50	753 901 064	0.188	170	72	65	6.8	4,6
75	63	753 901 065	0.209	170	72	65	6.8	5,8
90	50	753 901 072	0.289	190	81	61	8.2	4,6
90	63	753 901 071	0.316	190	81	65	8.2	5,8
90	75	753 901 070	0.330	190	81	72	8.2	6,8
110	63	753 901 078	0.487	205	85	65	10.0	5,8
110	75	753 901 077	0.501	205	84	72	10.0	6,8
110	90	753 901 076	0.549	205	85	81	10.0	8,2
125	63	753 901 083	0.607	214	88	65	11.4	5,8
125	75	753 901 082	0.667	210	89	72	11.4	6,8
125	90	753 901 081	0.683	211	89	81	11.4	8,2
125	110	753 901 080	0.775	211	90	84	11.4	10,0
140	75	753 901 086	0.910	237	113	77	12.7	6,8
140	90	753 901 087	0.954	237	114	86	12.7	8,2
140	110	753 901 084	0.977	232	104	93	12.7	10,0
140	125	753 901 085	1.078	232	102	100	12.7	11,4
160	90	753 901 088	1.164	244	100	81	14.6	8,2
160	110	753 901 090	1.239	242	100	85	14.6	10,0
160	125	753 901 089	1.333	240	100	89	14.6	11,4
160	140	753 901 032	1.522	255	110	104	14.6	12,7
180	90	753 901 073	1.507	245	105	81	16.4	8,2
180	110	753 901 074	1.833	277	124	94	16.4	10,0
180	125	753 901 091	1.723	258	108	92	16.4	11,4
180	140	753 901 075	1.976	278	124	113	16.4	12,7
180	160	753 901 033	1.968	255	107	102	16.4	14,6
200	140	753 901 066	2.326	282	123	114	18.2	12,7
200	160	753 901 092	2.435	252	104	120	18.2	14,6
200	180	753 901 034	2.724	279	124	120	18.2	16,4
225	140	753 901 067	2.900	295	132	115	20.5	12,7
225	160	753 901 096	2.891	278	120	98	20.5	14,6
225	180	753 901 095	3.244	297	128	120	20.5	16,4
225	200	753 901 094	3.538	280	124	117	20.5	18,2
250	160	753 901 000	2.385	309	150	97	22.7	14,6
250	180	753 901 068	4.299	312	150	106	22.7	16,4
250	200	753 901 001	4.766	327	155	115	22.7	18,2
250	225	753 901 002	2.385	332	130	120	22.7	20,5
280	200	753 901 098	6.850	347	140	115	25.4	18,2
280	225	753 901 099	6.112	340	140	122	25.4	20,5
280	250	753 901 003	2.385	320	137	133	25.4	22,7
315	200	753 901 004	7.522	375	170	128	28.6	18,2
315	225	753 901 097	7.790	375	150	123	28.6	20,5

table continued on the next page

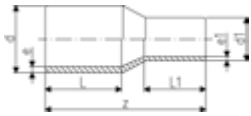

d (mm)	d1 (mm)	Code	Weight (kg)	z (mm)	L (mm)	L1 (mm)	e (mm)	e1 (mm)
315	250	753 901 005	8.360	375	150	132	28.6	22.7
315	280	753 901 012	8.800	375	150	144	28.6	25.4
355	250	753 901 013	9.100	390	165	130	32.3	22.7
355	280	753 901 014	9.500	390	165	139	32.3	25.4
355	315	753 901 015	9.900	390	165	150	32.3	28.6
400	280	753 901 016	10.420	415	180	139	36.4	25.4
400	315	753 901 017	11.130	415	180	150	36.4	28.6
400	355	753 901 018	11.600	420	180	165	36.4	32.3
450	280	753 901 019	16.200	389	195	139	40.9	25.4
450	315	753 901 020	16.700	390	195	150	40.9	28.6
450	355	753 901 022	17.500	393	195	164	40.9	32.3
450	400	753 901 024	18.500	395	195	179	40.9	36.4
500	315	753 901 025	21.900	422	212	150	45.5	28.6
500	355	753 901 026	22.600	424	212	164	45.5	32.3
500	400	753 901 027	23.600	426	212	179	45.5	36.4
500	450	753 901 029	25.100	428	212	195	45.5	40.9
560	355	753 901 030	30.100	459	230	164	50.9	32.3
560	400	753 901 039	31.000	461	230	179	50.9	36.4
560	450	753 901 040	32.400	463	230	195	50.9	40.9
560	500	753 901 043	34.100	466	230	212	50.9	45.5
630	400	753 901 044	41.900	502	250	179	57.3	36.4
630	450	753 901 045	43.100	503	250	195	57.3	40.9
630	500	753 901 049	44.700	506	250	212	57.3	45.5
630	560	753 901 050	46.800	506	250	230	57.3	50.9

Reducer PE100 SDR17/17,6



- Long spigot version
- 5 bar Gas / 10 bar Water

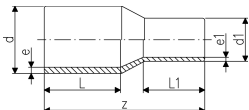

d	d1	Code	Weight	z	L1	L	e	e1
(mm)	(mm)		(kg)	(mm)	(mm)	(mm)	(mm)	(mm)
90	63	753 900 872	0.224	182	70	79	5.4	3,8
90	75	753 900 870	0.234	185	70	79	5.4	4,5
110	63	753 900 877	0.326	185	63	82	6.6	3,8
110	90	753 900 876	0.333	205	80	85	6.6	5,4
125	63	753 900 882	0.610	200	63	87	7.4	3,8
125	90	753 900 881	0.461	215	80	90	7.4	5,4
125	110	753 900 880	0.507	215	85	90	7.4	6,6
140	75	753 900 886	0.560	230	70	112	8.3	4,5
140	90	753 900 887	0.642	230	79	112	8.3	5,4
140	110	753 900 884	0.715	230	82	112	8.3	6,6
140	125	753 900 885	0.754	235	87	115	8.3	7,4
160	90	753 900 888	0.752	248	85	120	9.5	5,4
160	110	753 900 890	0.930	245	85	100	9.5	6,6
160	125	753 900 889	0.930	245	90	100	9.5	7,4
160	140	753 900 831	0.995	260	110	120	9.5	8,3
180	90	753 900 873	1.010	237	79	105	10.7	5,4
180	110	753 900 874	1.600	270	92	120	10.7	6,6
180	125	753 900 891	1.165	255	90	105	10.7	7,4
180	140	753 900 875	1.720	270	110	120	10.7	8,3
180	160	753 900 832	2.100	255	100	105	10.7	9,5
200	140	753 900 866	1.800	275	110	120	11.9	8,3
200	160	753 900 892	1.664	265	100	115	11.9	9,5
200	180	753 900 893	2.580	265	105	115	11.9	10,7
225	140	753 900 867	2.021	280	100	120	13.4	8,3
225	160	753 900 896	2.020	280	100	120	13.4	9,5
225	180	753 900 895	2.240	280	105	120	13.4	10,7
225	200	753 900 894	2.237	280	115	120	13.4	11,9
250	160	753 900 800	2.850	290	100	130	14.8	9,5
250	180	753 900 868	3.100	295	105	130	14.8	10,7
250	200	753 900 801	3.210	302	112	130	14.8	11,9
250	225	753 900 802	2.385	332	120	162	14.8	13,4
280	200	753 900 898	3.800	333	112	140	16.6	11,9
280	225	753 900 899	4.062	335	120	140	16.6	13,4
280	250	753 900 803	4.352	340	130	140	16.6	14,8
315	200	753 900 804	5.390	380	134	180	18.7	11,9
315	225	753 900 807	6.200	365	120	150	18.7	13,4
315	250	753 900 805	6.420	365	130	150	18.7	14,8
315	280	753 900 806	5.940	365	140	150	18.7	16,6
355	250	753 900 808	7.082	390	130	165	21.1	14,8
355	280	753 900 809	6.728	390	140	165	21.1	16,6
355	315	753 900 810	7.240	390	150	165	21.1	18,7
400	280	753 900 811	7.930	415	140	180	23.7	16,6
400	315	753 900 812	9.949	415	150	180	23.7	18,7
400	355	753 900 813	9.620	420	165	180	23.7	21,1
450	280	753 900 814	11.500	389	140	195	26.7	16,6
450	315	753 900 815	11.805	390	150	195	26.7	18,7
450	355	753 900 816	11.900	393	164	195	26.7	21,1
450	400	753 900 817	12.964	395	179	195	26.7	23,7
500	315	753 900 818	15.500	422	150	212	29.7	18,7
500	355	753 900 819	15.700	424	164	212	29.7	21,1
500	400	753 900 820	16.200	426	179	212	29.7	23,7
500	450	753 900 821	17.000	428	195	212	29.7	26,7
560	355	753 900 822	21.400	459	164	230	33.2	21,1
560	400	753 900 823	21.700	461	179	230	33.2	23,7
560	450	753 900 824	22.300	463	195	230	33.2	26,7
560	500	753 900 825	23.200	466	212	230	33.2	29,7
630	400	753 900 826	29.700	502	179	250	37.4	23,7
630	450	753 900 827	30.100	503	195	250	37.4	26,7

table continued on the next page

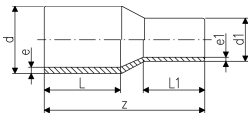

d (mm)	d1 (mm)	Code	Weight (kg)	z (mm)	L1 (mm)	L (mm)	e (mm)	e1 (mm)
630	500	753 900 828	30.800	506	212	250	37.4	29,7
630	560	753 900 829	31.900	506	230	250	37.4	33,3
710	500	753 900 833	58.796	790	300	300	42.1	29,7
710	560	753 900 834	60.578	770	300	300	42.1	33,2
710	630	753 900 835	62.448	740	300	300	42.1	37,4
800	560	753 900 836	75.842	800	300	300	47.4	33,2
800	630	753 900 837	78.255	780	300	300	47.4	37,4
800	710	753 900 838	80.504	750	300	300	47.4	42,1
900	630	753 900 839	99.282	820	300	300	53.3	37,4
900	710	753 900 840	100.908	790	300	300	53.3	42,1
900	800	753 900 841	103.578	760	300	300	53.3	47,4
1000	710	753 900 842	124.232	820	300	300	59.3	42,1
1000	800	753 900 843	125.277	780	300	300	59.3	47,4
1000	900	753 900 844	126.638	740	300	300	59.3	53,3

End caps

Cap PE100 SDR11



- Long spigot version
- 10 bar Gas / 16 bar Water

Note:

* Fabricated fitting made from pipe

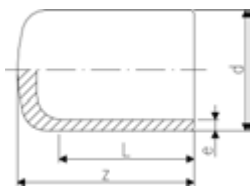

d (mm)	Code	Weight (kg)	z (mm)	L (mm)	e (mm)	
20	753 961 006	0.010	52	52	3.0	
25	753 961 007	0.015	52	52	3.0	
32	753 961 008	0.020	54	54	3.0	
40	753 961 009	0.033	57	57	3.7	
50	753 961 010	0.054	63	63	4.6	
63	753 961 011	0.086	65	65	5.8	
75	753 961 012	0.146	80	72	6.8	
90	753 961 013	0.240	90	81	8.2	
110	753 961 014	0.373	98	86	10.0	
125	753 961 015	0.546	105	92	11.4	
140	753 961 016	0.727	136	92	12.7	
160	753 961 017	1.034	120	102	14.6	
180	753 961 018	1.351	128	107	16.4	
200	753 961 019	1.845	138	115	18.2	
225	753 961 020	2.514	148	122	20.5	
250	753 961 021	3.927	205	130	22.7	
280	753 960 922	8.045	235	139	25.4	
315	753 960 923	6.861	255	150	28.6	
*	355	753 960 924	9.780	280	165	32.3
*	400	753 960 925	13.370	310	180	36.4
*	450	753 960 926	20.800	275	195	40.9
*	500	753 960 927	28.400	297	212	45.5
*	560	753 960 928	39.100	325	230	50.9
*	630	753 960 929	59.700	355	250	57.3



Cap PE100 SDR17/17,6

- Long spigot version
- 5 bar Gas / 10 bar Water

Note:

* Fabricated fitting made from pipe

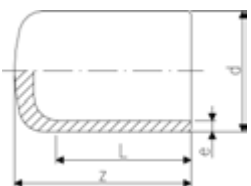



d (mm)	Code	Weight (kg)	z (mm)	L (mm)	e (mm)	
50	753 960 810	0.036	70	55	3.0	
63	753 960 811	0.058	82	63	3.8	
75	753 960 812	0.105	92	70	4.5	
90	753 960 813	0.214	90	81	5.4	
110	753 960 814	0.272	98	86	6.6	
125	753 960 815	0.487	105	92	7.4	
140	753 960 816	0.481	136	92	8.3	
160	753 960 817	0.920	120	102	9.5	
180	753 960 818	1.216	128	107	10.7	
200	753 960 819	1.687	138	115	11.9	
225	753 960 820	2.265	148	122	13.4	
250	753 960 821	2.547	205	130	14.8	
280	753 960 822	3.523	235	139	16.6	
315	753 960 823	4.758	255	150	18.7	
355	753 960 824	6.510	280	165	21.1	
400	753 960 825	9.347	310	180	23.7	
*	450	753 960 826	17.798	265	195	26.7
*	500	753 960 827	21.400	287	212	29.7
*	560	753 960 828	29.400	310	230	33.2
*	630	753 960 829	41.400	340	250	37.4
*	710	753 960 830	53.950	310	190	42.1
*	800	753 960 831	73.281	320	190	47.4
*	900	753 960 832	98.923	330	190	53.5
*	1000	753 960 833	123.925	340	190	59.3

ELGEF Plus stop-off valves

Stop-off valves PE100

Page

	Ball valves	90
	Extension spindles	91
	Accessories	93



Ball valves

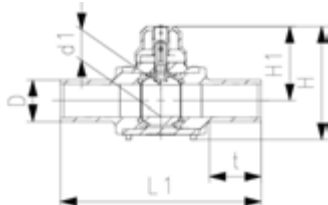

Ball valve

- PE 100 SDR 11 (ISO S5) - d20 up to d225
- 10 bar Gas / 16 bar Water
- d20 - d110 in accordance with DVGW GW336 / DVGW VP302 / DVGW W364
- d160 up to d225 are supplied with base plate and straps
- d1 = diameter of bore
- Regarding pressure rate and application local standards and regulations have to be considered
- * In accordance with ANSI B16.40

d (mm)	Code	Weight (kg)	d1 (mm)	L1 (mm)	H (mm)	H1 (mm)	t (mm)	
20	193 103 206	0.487	23	264	134	96	72	
25	193 103 207	0.490	23	264	134	96	72	
32	193 103 208	0.506	23	274	134	96	76	
40	193 103 209	0.616	30	301	142	100	85	
50	193 103 210	0.829	38	327	156	107	92	
63	193 103 211	1.174	48	350	173	114	101	
75	193 103 212	1.434	48	376	173	114	114	
90	193 103 213	2.918	68	439	240	158	128	
110	193 103 214	4.416	83	497	267	171	148	
125	193 103 040	4.220	62	400	280	195	106	
160	193 103 042	10.541	88	450	360	235	116	
180	193 103 043	10.524	88	540	360	235	117	
200	193 103 044	12.023	88	540	360	235	164	
*	225	193 103 045	24.400	120	880	470	322	240

Ball valve extension spindle



- Extension spindle made out of PVC
- 100% plastic solution for a non-corrosive system

Length (mm)	Code	Weight (kg)
400	173 103 080	0.770

Ball valve accessory kit



- Extension spindle made out of PVC
- 100% plastic solution for a non-corrosive system

Article	Code	Weight (kg)
Kit	173 103 056	1.695



Ball valve operational key

- Made out of PVC
- Suitable for all dimensions

Length (mm)	Code	Weight (kg)
200	173 103 082	0.378
500	173 103 083	0.753
1240	173 103 084	1.714



Ball valve "clearway"

- PE 100 SDR 11 (ISO S5) - d20 up to d225
- 10 bar Gas / 16 bar Water
- d1 = diameter of bore
- For extension spindles with polygon connection
- * In accordance with ANSI B16.40, MOP 6,9 bar Gas

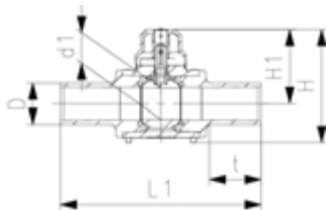

d (mm)	Code	Weight (kg)	d1 (mm)	L1 (mm)	H (mm)	H1 (mm)	t (mm)
110	193 104 039	8.973	88	425	350	229	100
160	193 104 042	24.254	132	600	473	320	98

Extension Spindle



Extension spindle for ball valve Telescopic

- For ELGEF Plus ball valve d125-d225mm
- For ELGEF Plus ball valve "Full Bore" d110mm and d160mm
- Continuously adjustable and self-supporting
- Pullout- and dirt-safe
- Rod hot-dip galvanized
- PE-casing and PE-centering cap with gasket
- Polygon-bush from galvanized steel
- PE-sleeve, fitted for all dimensions
- Torque max.140Nm

d-d (mm)	Pipe cover	Code	Weight (kg)	L (m)
125 - 225	0.75-1.10	173 103 075	2.100	0.60 - 0.96
125 - 225	1.10-1.80	173 103 076	3.108	0.95 - 1.60
125 - 225	1.65-2.75	173 103 077	7.200	1.40 - 2.50



Extension spindle for ball valve Telescopic

- For ELGEF Plus ball valve d20-d110mm
- Extension spindle acc. to DVGW GW336
- Steel square connection 20x20mm for d20-75
- Steel square connection 25x25mm for d90-d110
- Continuously adjustable and self-supporting
- Pullout- and dirt-safe
- Rod hot-dip galvanized
- PE-casing and PE-centering cap with gasket
- Inclusive clip-pin out of stainless steel
- Torque max.140Nm

d-d (mm)	Pipe cover (mm)	Code	L (m)
20 - 75	0.75-1.10	173 103 175	0.54 - 0.93
20 - 75	1.10-1.70	173 103 176	0.87 - 1.55
20 - 75	1.60-2.50	173 103 177	1.32 - 2.39
90 - 110	0.75-1.10	173 103 185	0.55 - 0.85
90 - 110	1.10-1.70	173 103 186	0.80 - 1.38
90 - 110	1.60-2.50	173 103 187	1.30 - 2.33



Extension spindle for tapping valves rigid

- PE-casing with anti-sand cap
- PE-sleeve, suitable for tapping valve
- Square bar steel, hot-dip galvanized
- Clip-pin from stainless steel 1.4301
- Bush CJS400-15 with slot and clip-pin (tool-free connection)

Pipe cover (m)	Code	Weight (kg)	L (m)
0.75	160 050 620	0.897	0.43
1.00	160 050 621	1.544	0.74
1.25	160 050 622	1.944	0.99
1.50	160 050 623	2.246	1.18



Extension spindle for tapping valve telescopic

- Continuously adjustable and self-supporting
- Pullout- and dirt-safe
- Rod hot-dip galvanized
- PE-casing and PE-centering cap with gasket
- Clip-pin from stainless steel 1.4301
- Bush GJS400-15 with slot and clip-pin (tool-free connection)
- PE-sleeve, suitable for tapping valve

Pipe cover (m)	Code	Weight (kg)	L (m)
0.75-1.00	160 050 520	1.475	0.45 - 0.70
1.00-1.50	160 050 521	2.356	0.76 - 1.30
1.30-1.90	160 050 522	2.881	0.93 - 1.55
1.70-2.70	160 050 523	2.000	1.30 - 2.35

Accessories

Base plate with straps

Code	Weight (kg)
173 103 081	0.945

Stem square cap



- For operation with operating key "C" in accordance with DIN 3223-C
- conical inner square
- Galvanized

L (mm)	Code	Weight (kg)
28	173 103 105	0.563

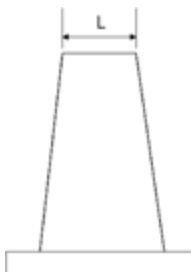

Polygon-adapter



- Polygon connection for Extension spindle ELGEF Plus ball valve d20-d110mm
- Fixation to steel square with grub screws
- Galvanized

d-d (mm)	Code	Weight (kg)
20 - 75	173 103 195	0.493
90 - 110	173 103 196	0.515

Utility product ranges

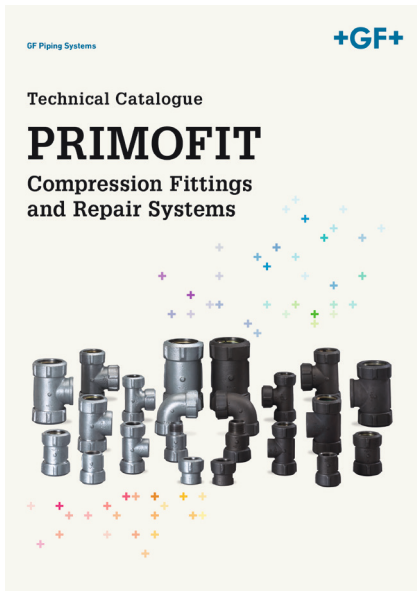

Technical Catalogue PRIMOFIT



Product Range iJOINT



Machines & Tools



Product Catalogue WAGA

Further Product Ranges you will find at:
www.gfps.com/download-center

ecoFIT

All you need in PE

- Polyethylene welded system for industrial applications



ecoFIT system

System specification



* Standards:







	PE100	PE80
Material		
Color	RAL 9005	RAL 9005
Density	~ 0.95 g/cm ³ (EN ISO 1183 / ASTM D 792)	~ 0.93 g/cm ³ (EN ISO 1183 / ASTM D 792)
Thermal expansion coefficient	0.15–0.20 mm/m K (DIN 53752)	0.15–0.20 mm/m K (DIN 53752)
Thermal conductivity at 23 °C	0.38 W/m K (EN 12664)	0.43 W/m K (EN 12664)
Thermal expansion	0.16–0.18 mm/m K	0.16–0.18 mm/m K
Yield stress at 23 °C	25 N/mm ² (EN ISO 527)	18 N/mm ² (EN ISO 527)
Tensile E-modul at 23 °C	900 N/mm ² (EN ISO 527)	700 N/mm ² (EN ISO 527)
Charpy notched impact strength at 23 °C	83 kJ/m ² (EN ISO 179)	110 kJ/m ² (EN ISO 179)
Charpy notched impact strength at -40 °C	13 kJ/m ² (EN ISO 179)	7 kJ/m ² (EN ISO 179)
Limiting Oxygen Index (LOI)	17.4 % (ISO 4589)	17.4 % (ISO 4589)
Dimensions	d20–d800 in accordance to EN ISO 15494	d20–d110 in accordance to EN ISO 15494
Surface condition	accordance to EN ISO 15494	accordance to EN ISO 15494
Material and product approvals	<ul style="list-style-type: none"> - DIBt (Deutsches Institut für Bautechnik) - FM Approvals (Factory Mutual) - IIP (Istituto Italiano dei Plastici) - GL (Germanischer Lloyd) - LR (Lloyd's Regist. of Shipping) - RINA (Registro Italiano Navale) - DNV (Det Norske Veritas) - CCS (China Classific. Society) - ABS (American Bureau of Shipping) - NK (Nippon Kaiji Kyokai) - RMROS (Russian Maritime Register of Shipping) 	<ul style="list-style-type: none"> - DIBt (Deutsches Institut für Bautechnik)
Packaging	Fittings and valves are bagged	Fittings and valves are bagged
Marking and labeling	All components are embossed with a permanent identification during the production process to ensure full traceability: <ul style="list-style-type: none"> <li style="width: 50%;">- Brand name <li style="width: 50%;">- Lot No. <li style="width: 50%;">- Material <li style="width: 50%;">- Product description <li style="width: 50%;">- Dimensions <li style="width: 50%;">- Article number <li style="width: 50%;">- Pressure rating <li style="width: 50%;">- Standard and approvals 	

* Approvals / Acceptance:



* An overview of all standards and approvals is stated online: www.gfps.com

PE for industrial systems

PE for industrial systems		Page
	ecoFit pipes	99
	ecoFit socket welding system	103
	ecoFit butt welding system	109
	Valves with PE ends	130



ecoFIT pipes PE100

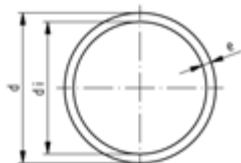

ecoFIT pressure pipe SDR 17,6/PN10/S8,3

Model:

- Material: PE100
- Dimension: acc. to DIN 8074/75
- Colour: black
- Pipe length: 6000mm, with plain ends
- **Note 1:** DIBT Z-40.23-406 Approval
- Attention: Pressure rates refer to operating temperatures at 20°C. Higher temperatures and aggressive flow media reduce pressure load (see above DIN and our technical documentation). Pressure load capacity has to be determined in consideration with safety demands of the respective applications and calculated in accordance.

Note	d (mm)	Code	Weight (kg/m)	e (mm)
1	25	193 017 307	0.139	1.8
1	32	193 017 308	0.198	2.0
1	40	193 017 309	0.288	2.3
1	50	193 017 310	0.445	2.9
1	63	193 017 311	0.695	3.6
1	75	193 017 312	0.987	4.3
1	90	193 017 313	1.400	5.1
1	110	193 017 314	2.100	6.3
1	125	193 017 315	2.690	7.1
1	140	193 017 316	3.370	8.0
1	160	193 017 317	4.400	9.1
1	180	193 017 318	5.540	10.2
1	200	193 017 319	6.860	11.4
1	225	193 017 320	8.640	12.8
	250	193 017 321	10.700	14.2
	280	193 017 322	13.300	15.9
	315	193 017 323	16.900	17.9
	355	193 017 324	21.400	20.1
	400	193 017 325	27.200	22.7
	450	193 017 326	34.300	25.5
	500	193 017 327	42.300	28.3

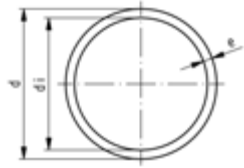

ecoFIT pressure pipe SDR 11/PN16/S5

Model:

- Material: PE100
- Dimension: acc. to DIN 8074/75
- Colour: black
- Pipe length: 6000mm, with plain ends
- **Note 1:** DIBT Z-40.23-406 Approval
- Attention: Pressure rates refer to operating temperatures at 20°C. Higher temperatures and aggressive flow media reduce pressure load (see above DIN and our technical documentation). Pressure load capacity has to be determined in consideration with safety demands of the respective applications and calculated in accordance.

Note	d (mm)	Code	Weight (kg/m)	e (mm)
1	16	193 017 355	0.084	1.8
1	20	193 017 356	0.118	2.0
1	25	193 017 357	0.173	2.3
1	32	193 017 358	0.282	3.0
1	40	193 017 359	0.434	3.7
1	50	193 017 360	0.673	4.6
1	63	193 017 361	1.060	5.8
1	75	193 017 362	1.480	6.8
1	90	193 017 363	2.140	8.2
1	110	193 017 364	3.180	10.0
1	125	193 017 365	4.120	11.4
1	140	193 017 366	5.130	12.7
1	160	193 017 367	6.740	14.6
1	180	193 017 368	8.510	16.4
1	200	193 017 369	10.500	18.2
1	225	193 017 370	13.300	20.5
	250	193 017 371	16.300	22.7
	280	193 017 372	20.500	25.4
	315	193 017 373	25.900	28.6
	355	193 017 374	32.900	32.2
	400	193 017 375	41.700	36.3
	450	193 017 376	52.800	40.9
	500	193 017 377	65.200	45.4

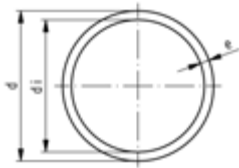

ecoFIT pipe SDR11/PN16/S5

Model:

- Material: PE100
- Dimension: acc. to DIN 8074/75
- Colour: black
- Pipe length: 5m, with plain ends
- **Note 1:** DIBT Z-40.23-406 Approval
- Attention: Pressure rates refer to operating temperatures at 20°C. Higher temperatures and aggressive flow media reduce pressure load (see above DIN and our technical documentation). Pressure load capacity has to be determined in consideration with safety demands of the respective applications and calculated in accordance.

Note	d (mm)	PN (bar)	Code	Weight (kg/m)	e (mm)
1	16	16	193 017 155	0.084	1.8
1	20	16	193 017 156	0.118	2.0
1	25	16	193 017 157	0.173	2.3
1	32	16	193 017 158	0.282	3.0
1	40	16	193 017 159	0.434	3.7
1	50	16	193 017 160	0.673	4.6
1	63	16	193 017 161	1.060	5.8
1	75	16	193 017 162	1.480	6.8
1	90	16	193 017 163	2.140	8.2
1	110	16	193 017 164	3.180	10.0
1	125	16	193 017 165	4.120	11.4
1	140	16	193 017 166	5.130	12.7
1	160	16	193 017 167	6.740	14.6
1	180	16	193 017 168	8.510	16.4
1	200	16	193 017 169	10.500	18.2
1	225	16	193 017 170	13.300	20.5
	250	16	193 017 171	16.300	22.7
	280	16	193 017 172	20.500	25.4
	315	16	193 017 173	25.900	28.6
	355	16	193 017 174	32.900	32.2
	400	16	193 017 175	41.700	36.3
	450	16	193 017 176	52.800	40.9
	500	16	193 017 177	65.200	45.4

ecoFIT stiffener

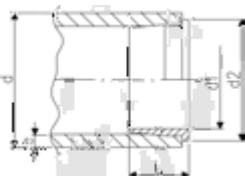

Model:

- Material: PE100
- Used as support during d20 and d25 socket fusion jointing to prevent the pipe from collapsing during the heating and jointing process.

d (mm)	Code	Weight (kg/m)	L (mm)	e (mm)	d1 (mm)	D2 (mm)	d2 (mm)
20	733 900 006	0.001	10	1.9	14	18	18
25	733 900 007	0.001	11	2.3	18	22	23

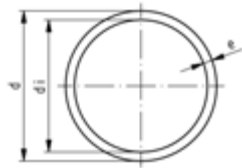

ecoFIT pipe SDR17,6/PN10/S8,3

Model:

- Material: PE100
- Dimension: acc. to DIN 8074/75
- Colour: black
- Pipe length: 5m, with plain ends
- **Note 1:** DIBT Z-40.23-406 Approval
- Attention: Pressure rates refer to operating temperatures at 20°C. Higher temperatures and aggressive flow media reduce pressure load (see above DIN and our technical documentation). Pressure load capacity has to be determined in consideration with safety demands of the respective applications and calculated in accordance.

Note	d (mm)	Code	Weight (kg/m)	e (mm)
1	25	193 017 107	0.139	1.8
1	32	193 017 108	0.198	2.0
1	40	193 017 109	0.288	2.3
1	50	193 017 110	0.445	2.9
1	63	193 017 111	0.695	3.6
1	75	193 017 112	0.987	4.3
1	90	193 017 113	1.400	5.1
1	110	193 017 114	2.100	6.3
1	125	193 017 115	2.690	7.1
1	140	193 017 116	3.370	8.0
1	160	193 017 117	4.400	9.1
1	180	193 017 118	5.540	10.2
1	200	193 017 119	6.860	11.4
1	225	193 017 120	8.640	12.8
	250	193 017 121	10.700	14.2
	280	193 017 122	13.300	15.9
	315	193 017 123	16.900	17.9
	355	193 017 124	21.400	20.1
	400	193 017 125	27.200	22.7
	450	193 017 126	34.300	25.5
	500	193 017 127	42.300	28.3

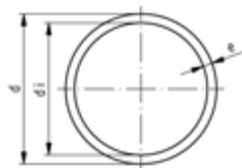

ecoFIT pipe SDR7,4/PN20/S3,2

Model:

- Material: PE100
- Dimension: acc. to DIN 8074/75
- Colour: black
- Pipe length: 5000mm, with plain ends
- Attention: Pressure rates refer to operating temperatures at 20°C. Higher temperatures and aggressive flow media reduce pressure load (see above DIN and our technical documentation). Pressure load capacity has to be determined in consideration with safety demands of the respective applications and calculated in accordance.

* SDR 6

	d (mm)	Code	Weight (kg/m)	e (mm)
*	10	193 017 203	0.048	1.8
	12	193 017 204	0.060	1.8
	16	193 017 205	0.103	2.3
	20	193 017 206	0.164	3.0
	25	193 017 207	0.243	3.5

ecoFIT socket fusion fittings

ecoFIT elbow 90°



Model:

- Material: PE80

d (mm)	PN (bar)	Code	Weight (kg)	D (mm)	L (mm)	z (mm)
20	10	733 100 106	0.022	31	28	14
25	10	733 100 107	0.031	36	32	16
32	10	733 100 108	0.048	44	38	20
40	10	733 100 109	0.078	54	44	24
50	10	733 100 110	0.129	66	51	28
63	10	733 100 111	0.228	82	62	35
75	10	733 100 112	0.311	93	76	45
90	10	733 100 113	0.498	110	88	53
110	10	733 100 114	0.864	134	106	65

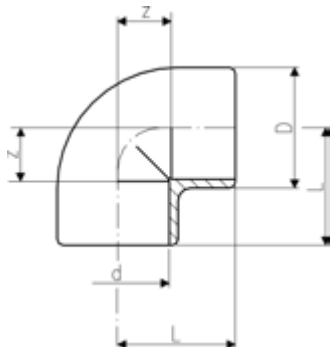

ecoFIT elbow 45°



Model:

- Material: PE80

d (mm)	PN (bar)	Code	Weight (kg)	D (mm)	L (mm)	z (mm)
20	10	733 150 106	0.018	31	21	7
25	10	733 150 107	0.026	36	24	8
32	10	733 150 108	0.043	44	28	10
40	10	733 150 109	0.061	53	33	13
50	10	733 150 110	0.087	64	36	13
63	10	733 150 111	0.184	82	43	16
75	10	733 150 112	0.229	93	51	20
90	10	733 150 113	0.357	114	58	23
110	10	733 150 114	0.653	134	68	27

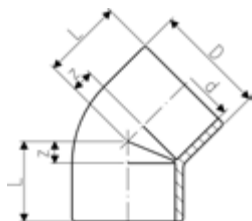

ecoFIT tee 90° equal



Model:

- Material: PE80

d (mm)	PN (bar)	Code	Weight (kg)	D (mm)	L (mm)	z (mm)
20	10	733 200 106	0.028	31	28	14
25	10	733 200 107	0.041	36	32	16
32	10	733 200 108	0.060	44	38	20
40	10	733 200 109	0.100	54	44	24
50	10	733 200 110	0.166	66	51	28
63	10	733 200 111	0.298	82	62	35
75	10	733 200 112	0.409	93	76	45
90	10	733 200 113	0.749	114	88	53
110	10	733 200 114	1.112	134	106	65



ecoFIT socket equal

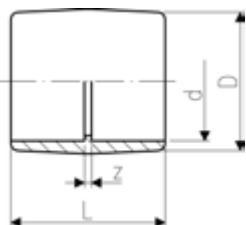

Model:

- Material: PE80

d (mm)	PN (bar)	Code	Weight (kg)	D (mm)	L (mm)	z (mm)
20	10	733 910 106	0.014	31	35	7
25	10	733 910 107	0.018	36	39	7
32	10	733 910 108	0.027	44	43	7
40	10	733 910 109	0.043	54	48	8
50	10	733 910 110	0.074	66	54	8
63	10	733 910 111	0.124	82	62	8
75	10	733 910 112	0.152	93	70	8
90	10	733 910 113	0.234	112	81	11
110	10	733 910 114	0.419	134	96	14

ecoFIT reducer

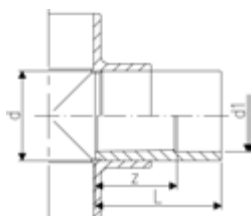
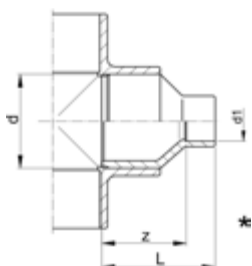

Model:

- Material: PE80
- With socket fusion spigot and fusion socket metric

d (mm)	d1 (mm)	PN (bar)	Code	Weight (kg)	L (mm)	z (mm)
25	20	10	733 910 337	0.013	39	23
32	25	10	733 910 341	0.021	43	27
*	40	20	733 910 348	0.023	48	34
*	40	25	733 910 347	0.027	48	32
	40	32	733 910 346	0.032	48	30
*	50	32	733 910 353	0.042	54	36
	50	40	733 910 352	0.049	54	34
*	63	20	733 910 362	0.057	64	50
*	63	25	733 910 361	0.060	64	48
*	63	32	733 910 360	0.065	64	46
*	63	40	733 910 359	0.070	64	44
	63	50	733 910 358	0.086	64	41
	75	63	733 910 364	0.103	62	35
*	90	63	733 910 371	0.180	88	62
	90	75	733 910 370	0.144	70	39
	110	90	733 910 376	0.254	81	45

ecoFIT end cap



Model:

- Material: PE80

d (mm)	PN (bar)	Code	Weight (kg)	D (mm)	L (mm)
20	10	733 960 106	0.010	30	27
25	10	733 960 107	0.016	36	30
32	10	733 960 108	0.025	44	34
40	10	733 960 109	0.038	53	38
50	10	733 960 110	0.061	65	44
63	10	733 960 111	0.097	80	51
75	10	733 960 112	0.150	91	66
90	10	733 960 113	0.274	111	77
110	10	733 960 114	0.405	137	93

ecoFIT unions for socket fusion

ecoFIT adaptor union metric

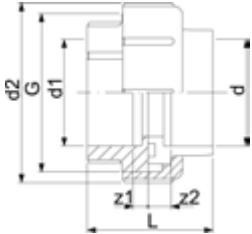

Model:

- Material: PE80
- Union End: Fusion socket, PE80 metric
- Union bush: brass with fusion socket insert, PE80 metric
- Union Nut: brass
- Gasket: O-ring NBR (Nitrile-rubber)

d	d1	PN	Code	Weight	G	L	z1	D2	d2	z2
(mm)	(mm)	(bar)		(kg)	(inch)	(mm)	(mm)	(mm)	(mm)	(mm)
20	20	10	733 580 106	0.163	1 1/4	46	6	46	46	3
25	25	10	733 580 107	0.214	1 1/2	49	6	52	52	3
32	32	10	733 580 108	0.294	2	51	6	64	64	3
40	40	10	733 580 109	0.473	2 1/2	56	8	79	79	3
50	50	10	733 580 110	0.491	2 2/3	61	8	85	85	3
63	63	10	733 580 111	0.730	3 1/2	69	8	104	104	3

ecoFIT adaptor union metric Rp

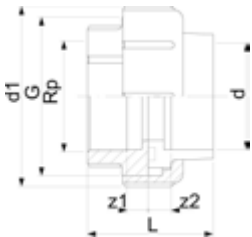

Model:

- Material: PE80/brass
- Union End: Fusion socket, PE80 metric
- Union bush: nickel-plated, parallel female thread Rp
- Union Nut: brass
- Gasket: O-ring NBR (Nitrile-rubber)

d	Rp	PN	Code	Weight	G	d1	L	z1	z2
(mm)	(inch)	(bar)		(kg)	(inch)	(mm)	(mm)	(mm)	(mm)
20	½	10	733 580 206	0.209	1 1/4	46	46	6	10
25	¾	10	733 580 207	0.269	1 1/2	52	48	6	9
32	1	10	733 580 208	0.376	2	64	51	6	8
40	1 ¼	10	733 580 209	0.596	2 1/2	79	56	8	7
50	1 ½	10	733 580 210	0.666	2 3/4	85	59	8	7
63	2	10	733 580 211	0.960	3 1/2	104	65	8	5

ecoFIT adaptor union metric R

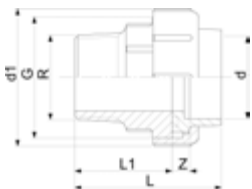

Model:

- Material: PE80/brass
- Union End: Fusion socket, PE80 metric
- Union bush: nickel-plated, taper male thread R
- Union Nut: brass
- Gasket: O-ring NBR (Nitrile-rubber)

d	R	PN	Code	Weight	d1	G	L	L1	z
(mm)	(inch)	(bar)		(kg)	(mm)	(inch)	(mm)	(mm)	(mm)
20	½	10	733 580 706	0.260	46	1 1/4	62	40	6
25	¾	10	733 580 707	0.324	52	1 1/2	65	41	6
32	1	10	733 580 708	0.470	64	2	71	45	6
40	1 ¼	10	733 580 709	0.754	79	2 1/2	78	48	8
50	1 ½	10	733 580 710	0.781	85	2 3/4	81	43	8
63	2	10	733 580 711	1.166	104	3 1/2	91	54	8



ecoFIT union end

Model:

- Material: PE80
- With fusion socket metric
- Suitable for unions, tank connectors and diaphragm valves Type 514

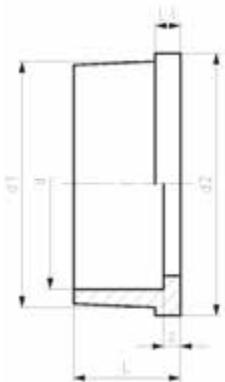

d (mm)	PN (bar)	Code	Weight (kg)	d1 (mm)	d2 (mm)	L (mm)	L1 (mm)	z (mm)
20	10	734 600 106	0.006	28	30	19	5	5
25	10	734 600 107	0.013	36	39	21	5	5
32	10	734 600 108	0.015	42	45	23	6	5
40	10	734 600 109	0.026	53	57	25	6	5
50	10	734 600 110	0.027	59	63	28	7	5
63	10	734 600 111	0.044	74	79	32	8	5



O-Ring gasket

Model:

- For flange adaptors
- Hardness approx. 65° Shore

d (mm)	DN (mm)	EPDM Code	Weight (kg)	FKM Code	Weight (kg)	D (mm)	D1 (mm)	D2 (mm)	closest inch (inch)
16	10	748 410 000	0.002	749 410 000	0.005	26	19	3.53	3/8
20	15	748 410 001	0.002	749 410 001	0.002	31	23	3.53	1/2
25	20	748 410 007	0.002	749 410 007	0.002	35	28	3.53	3/4
32	25	748 410 002	0.003	749 410 002	0.003	43	36	3.53	1
40	32	748 410 003	0.004	749 410 003	0.002	55	44	5.34	1 1/4
50	40	748 410 012	0.004	749 410 012	0.008	64	53	5.34	1 1/2
63	50	748 410 013	0.006	749 410 013	0.011	80	69	5.34	2
75	65	748 410 014	0.007	749 410 014	0.012	93	82	5.34	2 1/2
90	80	748 410 015	0.008	749 410 015	0.015	112	101	5.34	3
110	100	748 410 016	0.016	749 410 016	0.031	134	120	6.99	4
315	300			749 410 174	0.083	356	342	6.99	12

ecoFIT adaptor fittings for socket fusion

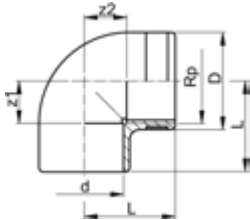

ecoFIT elbow 90° metric Rp

Model:

- Material: PE80
- With fusion socket metric and parallel female thread Rp, reinforced
- Reinforcing ring stainless (A2)
- Connection to plastic or metal threads
- Do not use thread sealing pastes that are harmful to PE
- Install with low mechanical stress and avoid large cyclic temperature changes

d (mm)	Rp (inch)	PN (bar)	Code	Weight (kg)	D (mm)	L (mm)	z1 (mm)	z2 (mm)
20	¾	10	733 100 206	0.024	30	28	14	14
25	¾	10	733 100 207	0.033	35	32	16	16
32	1	10	733 100 208	0.061	44	38	20	20
40	1 ¼	10	733 100 209	0.094	54	44	24	24

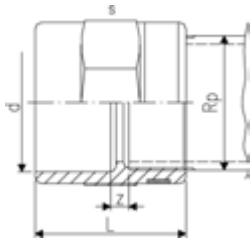

ecoFIT adaptor socket metric Rp

Model:

- Material: PE80
- Reinforcing ring stainless (A2)
- Connection to plastic or metal threads
- With fusion socket metric and parallel female thread Rp, reinforced
- Do not use thread sealing pastes that are harmful to PE
- Install with low mechanical stress and avoid large cyclic temperature changes

d (mm)	Rp (inch)	PN (bar)	Code	Weight (kg)	L (mm)	s (mm)	z (mm)
20	¾	10	733 910 206	0.020	35	32	7
25	¾	10	733 910 207	0.026	39	36	7
32	1	10	733 910 208	0.042	45	46	7
40	1 ¼	10	733 910 209	0.068	53	55	7
50	1 ½	10	733 910 210	0.098	54	65	9
63	2	10	733 910 211	0.155	62	80	9

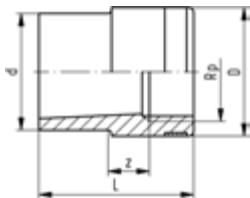

ecoFIT reducing bush metric Rp

Model:

- Material: PE80
- Reinforcing ring stainless (A2)
- Connection to plastic or metal threads
- Do not use thread sealing pastes that are harmful to PE
- Install with low mechanical stress and avoid large cyclic temperature changes
- With fusion spigot metric and BSP parallel female thread, reinforced

d (mm)	Rp (inch)	PN (bar)	Code	Weight (kg)	L (mm)	z (mm)
20	¾	10	733 910 434	0.012	33	7
25	¾	10	733 910 437	0.015	37	6
32	¾	10	733 910 441	0.028	43	8
40	1	10	733 910 446	0.046	49	9
50	1 ¼	10	733 910 452	0.071	55	10

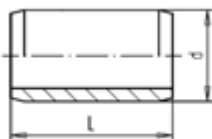

ecoFIT barrel nipple metric

Model:

- Material: PE100
- With fusion spigots on both sides
- For the shortest possible distance between fittings

* In these two sizes, stiffeners Code No. 733 900 006 (20 x 1,9) and 733 900 007 (25 x 2.3) must be used with socket fusion joints.

	d (mm)	PN (bar)	Code	Weight (kg)	L (mm)
*	20	10	753 910 906	0.005	40
*	25	10	753 910 907	0.006	40
	32	10	753 910 908	0.010	50
	40	10	753 910 909	0.017	50
	50	10	753 910 910	0.029	60
	63	10	753 910 911	0.058	70
	75	10	753 910 912	0.095	74
	90	10	753 910 913	0.163	89
	110	10	753 910 914	0.305	110

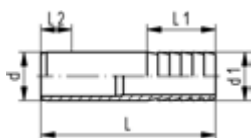

ecoFIT hose connector metric

Model:

- Material: PE100
- With socket fusion spigot metric and parallel hose connection

d	d1	PN	Code	Weight	L	L1	L2
(mm)	(mm)	(bar)		(kg)	(mm)	(mm)	(mm)
20	20	10	753 960 406	0.006	55	27	14
25	25	10	753 960 407	0.015	68	36	16
32	32	10	753 960 408	0.024	77	36	18
40	40	10	753 960 409	0.035	80	42	20
50	50	10	753 960 410	0.056	90	48	23
63	60	10	753 960 411	0.093	100	50	27

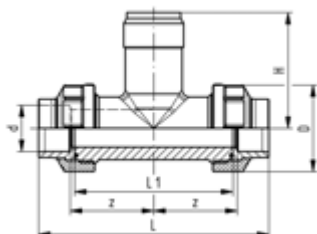

ecoFIT installation fitting type 310 For socket systems metric

Range of use:

- Compatible Signet flow sensors: type 2551, 2537, 515, 8510, 2536, 8512
- Compatible Signet pH/ORP sensors: type 2724, 2725, 2726, 2734, 2736, 2735

Attention:

- sensor length depends on installation fitting

Model:

- Material: PP-H/PE80
- Threaded outlet 1 ¼" NPSM
- Union end with fusion socket PE80
- Body and union nut PP-H

d	DN	EPDM Code	Weight	FKM Code	D	z	L	L1	H	Sensor Type
(mm)	(mm)		(kg)		(mm)	(mm)	(mm)	(mm)	(mm)	
20	15	733 310 006	0.136	733 310 036	48	50	128	90	76	flow X0, pH XX
25	20	733 310 007	0.190	733 310 037	58	55	421	100	78	flow X0, pH XX
32	25	733 310 008	0.250	733 310 038	65	60	156	110	81	flow X0, pH XX
40	32	733 310 009	0.356	733 310 039	79	60	160	110	85	flow X0, pH XX
50	40	733 310 010	0.510	733 310 040	91	65	176	120	89	flow X0, pH XX
63	50	733 310 011	0.800	733 310 041	105	70	194	130	95	flow X0, pH XX

ecoFIT butt welding system

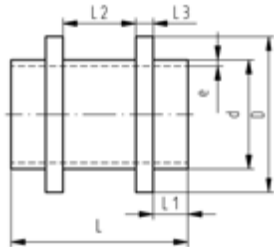
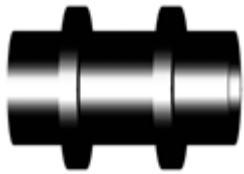

ecoFIT fixpoint fitting SDR11

Model:

- Material: PE100
- Conventional butt-welding according to DVS 2207
- Machined
- IR = Infrared-(IR Plus) compatible. Choose fusion parameters: PE100

d (mm)	FM	Code	Weight (kg)	D (mm)	L (mm)	L1 (mm)	L2 (mm)	L3 (mm)	e (mm)
63	IR	753 665 558	0.182	90	122	30	42	10	5.8
75	IR	753 665 559	0.265	110	122	30	42	10	6.8
90	IR	753 665 560	0.357	125	122	30	42	10	8.2
110	IR	753 665 561	0.610	140	142	30	52	15	10.0
125	IR	753 665 562	0.811	160	152	35	52	15	11.4
140	IR	753 665 563	1.068	180	162	40	52	15	12.7
160	IR	753 665 564	1.349	200	162	40	52	15	14.6
180	IR	753 665 565	2.001	225	182	45	52	20	16.4
200	IR	753 665 566	2.469	250	182	45	52	20	18.2
225	IR	753 665 567	3.438	280	192	45	52	25	20.5
250		753 665 568	3.858	280	212	50	62	25	22.7
280		753 665 569	5.217	315	222	50	62	30	25.4
315		753 665 570	6.627	355	222	50	62	30	28.6
355		753 665 571	7.731	400	192	30	62	35	32.2
400		753 665 572	10.890	450	212	30	72	40	36.3
450		753 665 573	14.775	500	232	35	72	45	40.9
500		753 665 574	20.268	560	252	40	72	50	45.4
560		753 665 575	28.608	630	282	45	82	55	50.8
630		753 665 576	39.129	710	302	50	82	60	57.2

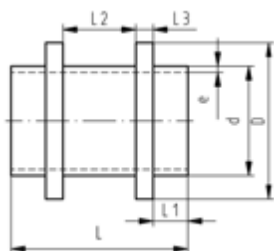
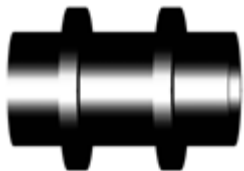

ecoFIT fixpoint fitting SDR17/17.6

Model:

- Material: PE100
- Conventional butt-welding according to DVS 2207
- IR = Infrared-(IR Plus) compatible. Choose fusion parameters: PE100
- Machined

d (mm)	FM	Code	Weight (kg)	D (mm)	L (mm)	L1 (mm)	L2 (mm)	L3 (mm)	e (mm)
63	IR	753 665 577	0.144	90	122	30	42	10	3.8
75	IR	753 665 578	0.212	110	122	30	42	10	4.5
90	IR	753 665 579	0.279	125	122	30	42	10	5.4
110	IR	753 665 580	0.457	140	142	30	52	15	6.6
125	IR	753 665 581	0.618	160	152	35	52	15	7.4
140	IR	753 665 582	0.815	180	162	40	52	15	8.3
160	IR	753 665 583	1.014	200	162	40	52	15	9.5
180	IR	753 665 584	1.528	225	182	45	52	20	10.7
200	IR	753 665 585	1.887	250	182	45	52	20	11.9
225	IR	753 665 586	2.661	280	192	45	52	25	13.4
250		753 665 587	2.796	280	212	50	62	25	14.8
280		753 665 588	3.829	315	222	50	62	30	16.6
315		753 665 589	4.871	355	222	50	62	30	18.7
355		753 665 590	5.812	400	192	30	62	35	21.1
400		753 665 591	8.180	450	212	30	72	40	23.7
450		753 665 592	11.015	500	232	35	72	45	26.7
500		753 665 593	15.251	560	252	40	72	50	29.7
560		753 665 594	21.557	630	282	45	82	55	33.2
630		753 665 595	29.574	710	302	50	82	60	37.4



ecoFIT bend 90° SDR11

Model:

- Material: PE100
- Conventional butt-welding according to DVS 2207
- IR = Infrared-(IR Plus) compatible. Choose fusion parameters: PE100

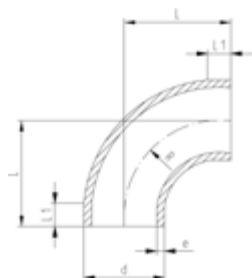

d (mm)	FM	Code	Weight (kg)	L (mm)	L1 (mm)	R (mm)	e (mm)
20	IR	753 018 706	0.007	38	23	15.00	1.9
25	IR	753 018 707	0.013	42	23	19.00	2.3
32	IR	753 018 708	0.025	46	22	24.00	2.9
40	IR	753 018 709	0.041	51	21	30.00	3.7
50	IR	753 018 710	0.065	58	21	37.00	4.6
63	IR	753 018 711	0.124	66	21	45.00	5.8
75	IR	753 018 742	0.190	75	21	71.25	6.8
90	IR	753 018 743	0.325	90	22	85.50	8.2
110	IR	753 018 744	0.590	110	25	104.50	10.0
125	IR	753 018 715	0.818	125	28	116.00	11.4
140	IR	753 018 716	1.148	140	33	131.00	12.7
160	IR	753 018 717	1.699	160	33	151.00	14.6
180	IR	753 018 718	2.394	180	33	171.00	16.4
200	IR	753 018 719	3.264	200	33	190.00	18.2
225	IR	753 018 720	4.535	220	33	210.00	20.5
250		753 018 621	6.713	256	48	232.00	22.7
280		753 018 622	9.885	286	52	263.00	25.4
315		753 018 623	14.158	321	48	297.00	28.6
355		753 018 624	18.000	345	70	330.00	32.3
400		753 018 625	24.020	365	70	350.00	36.3
450		753 018 626	35.360	425	70	400.00	40.9
500		753 018 627	47.370	470	90	445.00	45.5



ecoFIT bend 90° SDR17/17.6

Model:

- Material: PE100
- Conventional butt-welding according to DVS 2207
- IR = Infrared-(IR Plus) compatible. Choose fusion parameters: PE100

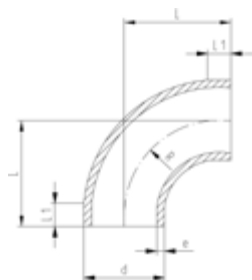

d (mm)	FM	Code	Weight (kg)	L (mm)	L1 (mm)	R (mm)	e (mm)
50	IR	753 018 635	0.052	58	21	37.00	2.9
63	IR	753 018 636	0.087	66	21	45.00	3.6
75	IR	753 018 637	0.133	75	21	71.25	4.5
90	IR	753 018 638	0.226	90	22	85.50	5.4
110	IR	753 018 639	0.407	110	25	104.50	6.6
125	IR	753 018 515	0.556	125	28	116.00	7.3
140	IR	753 018 516	0.785	140	33	131.00	8.2
160	IR	753 018 517	1.156	160	33	151.00	9.4
180	IR	753 018 518	1.619	180	33	171.00	10.6
200	IR	753 018 519	2.208	200	33	190.00	11.7
225	IR	753 018 520	3.039	220	33	210.00	12.9
250		753 018 521	4.645	256	48	232.00	14.2
280		753 018 522	7.020	286	48	262.00	15.9
315		753 018 523	10.099	321	48	297.00	17.9
355		753 018 524	12.580	345	70	330.00	21.1
400		753 018 525	16.680	365	70	350.00	23.7
450		753 018 526	24.760	425	70	400.00	26.7
500		753 018 527	33.640	470	90	445.00	29.7



ecoFIT elbow 90° SDR11

Model:

- Material: PE100
- Conventional butt-welding according to DVS 2207
- IR = Infrared-(IR Plus) compatible. Choose fusion parameters: PE100

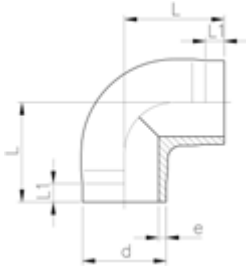

d (mm)	FM	Code	Weight (kg)	L (mm)	L1 (mm)	e (mm)
20	IR	753 108 606	0.009	38	25	1.9
25	IR	753 108 607	0.013	42	26	2.3
32	IR	753 108 608	0.026	46	27	2.9
40	IR	753 108 609	0.047	51	22	3.7
50	IR	753 108 610	0.086	58	23	4.6
63	IR	753 108 611	0.150	66	21	5.8



ecoFIT elbow 45° SDR11

Model:

- Material: PE100
- Conventional butt-welding according to DVS 2207
- IR = Infrared-(IR Plus) compatible. Choose fusion parameters: PE100

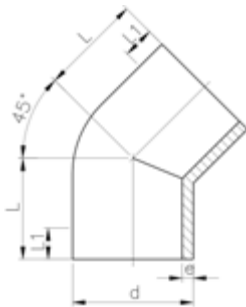

d (mm)	FM	Code	Weight (kg)	L (mm)	L1 (mm)	e (mm)
20	IR	753 158 606	0.007	32	24	1.9
25	IR	753 158 607	0.013	34	25	2.3
32	IR	753 158 608	0.019	36	25	2.9
40	IR	753 158 609	0.036	39	25	3.7
50	IR	753 158 610	0.059	42	26	4.6
63	IR	753 158 611	0.103	47	29	5.8
75	IR	753 158 612	0.146	49	29	6.8
90	IR	753 158 613	0.241	57	34	8.2
110	IR	753 158 614	0.442	70	43	10.0
125	IR	753 158 615	0.638	79	48	11.4
140	IR	753 158 616	0.902	88	55	12.7
160	IR	753 158 617	1.340	100	60	14.6
200	IR	753 158 619	2.612	124	75	18.2
225	IR	753 158 620	3.638	140	85	20.5



ecoFIT elbow 45° SDR17.6

Model:

- Material: PE100
- Conventional butt-welding according to DVS 2207
- IR = Infrared-(IR Plus) compatible. Choose fusion parameters: PE100

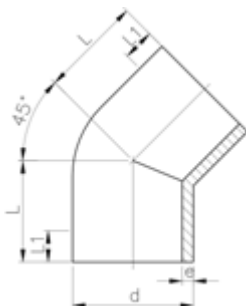

d (mm)	FM	Code	Weight (kg)	L (mm)	L1 (mm)	e (mm)
50	IR	753 158 535	0.045	42	26	2.9
63	IR	753 158 536	0.091	47	29	3.6
75	IR	753 158 412	0.125	49	29	4.7
90	IR	753 158 413	0.198	57	34	5.6
110	IR	753 158 414	0.375	70	43	6.9
125	IR	753 158 540	0.542	79	48	7.1
140	IR	753 158 541	0.784	88	55	8.0
160	IR	753 158 542	1.190	100	60	9.1
200	IR	753 158 544	2.331	124	75	11.4
225	IR	753 158 545	3.282	140	85	12.8

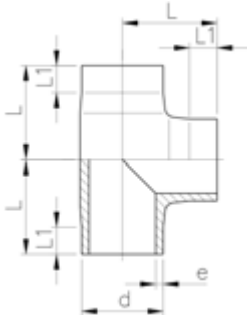

ecoFIT tee 90° equal SDR11

Model:

- Material: PE100
- Conventional butt-welding according to DVS 2207
- IR = Infrared-(IR Plus) compatible. Choose fusion parameters: PE100

d (mm)	FM	Code	Weight (kg)	L (mm)	L1 (mm)	e (mm)
20	IR	753 208 606	0.013	38	24	1.9
25	IR	753 208 607	0.021	42	26	2.3
32	IR	753 208 608	0.042	46	26	2.9
40	IR	753 208 609	0.065	51	22	3.7
50	IR	753 208 610	0.111	58	22	4.6
63	IR	753 208 611	0.202	66	21	5.8
75	IR	753 208 612	0.312	75	20	6.8
90	IR	753 208 613	0.553	90	20	8.2
110	IR	753 208 614	1.002	110	20	10.0
125	IR	753 208 615	1.509	125	25	11.4
140	IR	753 208 616	2.105	140	28	12.7
160	IR	753 208 617	3.085	160	28	14.6
180	IR	753 208 668	5.062	190	70	16.4
200	IR	753 208 619	5.982	200	35	18.2
225	IR	753 208 620	8.090	220	35	20.5
250		753 208 671	13.326	272	90	22.7
280		753 208 672	20.458	313	108	25.4
315		753 208 673	27.400	348	114	28.6
355		753 208 624	32.600	345	105	32.3
400		753 208 625	42.900	365	105	36.4
450		753 208 626	63.300	425	135	40.9
500		753 208 627	86.000	470	155	45.5

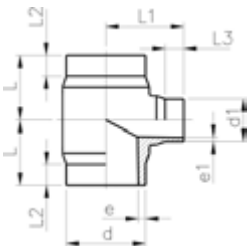

ecoFIT tee 90° reduced SDR11

Model:

- Material: PE100
- Conventional butt-welding according to DVS 2207
- IR = Infrared-(IR Plus) compatible. Choose fusion parameters: PE100

d (mm)	d1 (mm)	FM	Code	Weight (kg)	L (mm)	L1 (mm)	L2 (mm)	L3 (mm)	e (mm)	e1 (mm)
63	32	IR	753 208 351	0.161	65	70	25	25	5.8	2.9
63	50	IR	753 208 352	0.180	65	70	25	25	5.8	4.6
75	32	IR	753 208 353	0.255	70	75	25	25	6.8	2.9
75	50	IR	753 208 354	0.265	70	75	25	25	6.8	4.6
75	63	IR	753 208 355	0.278	70	75	25	25	6.8	5.8
90	50	IR	753 208 357	0.435	80	85	25	25	8.2	4.6
90	63	IR	753 208 358	0.448	80	85	25	25	8.2	5.8
90	75	IR	753 208 359	0.462	80	85	25	25	8.2	6.8
110	32	IR	753 208 360	0.685	90	95	30	25	10.0	2.9
110	50	IR	753 208 361	0.694	90	95	30	25	10.0	4.6
110	63	IR	753 208 362	0.709	90	95	30	25	10.0	5.8
110	75	IR	753 208 363	0.717	90	95	30	25	10.0	6.8
110	90	IR	753 208 364	0.734	90	95	30	25	10.0	8.2
160	63	IR	753 208 371	2.269	142	135	50	30	14.6	5.8
160	75	IR	753 208 372	2.255	142	135	50	30	14.6	6.8
160	90	IR	753 208 373	2.317	142	135	50	30	14.6	8.2
160	110	IR	753 208 374	2.353	142	135	50	30	14.6	10.0
225	90	IR	753 208 388	4.759	155	165	40	30	20.5	8.2
225	110	IR	753 208 389	4.796	155	165	40	30	20.5	10.0
225	160	IR	753 208 391	4.854	155	165	40	30	20.5	14.6
250	110		753 221 031	8.199	228	197	140	37	22.7	10.0
250	160		753 221 032	8.564	229	219	117	60	22.7	14.6



ecoFIT tee 90° reduced SDR17.6

Model:

- Material: PE100
- Conventional butt-welding according to DVS 2207
- IR = Infrared-(IR Plus) compatible. Choose fusion parameters: PE100
- 5 bar Gas / 10 bar Water
- * Branch SDR11

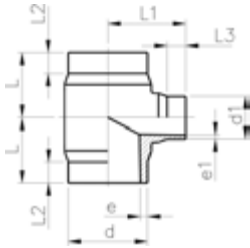

	d	d1	FM	Code	Weight	L	L1	L2	L3	e	e1
	(mm)	(mm)			(kg)	(mm)	(mm)	(mm)	(mm)	(mm)	(mm)
*	63	32	IR	753 208 301	0.163	65	70	25	25	3.6	2.9
	63	50	IR	753 208 302	0.171	65	70	25	25	3.6	2.9
*	75	32	IR	753 208 303	0.231	70	75	25	25	4.3	2.9
	75	50	IR	753 208 304	0.250	70	75	25	25	4.3	2.9
	75	63	IR	753 208 305	0.263	70	75	25	25	4.3	3.6
	90	50	IR	753 208 307	0.411	80	85	25	25	5.1	2.9
	90	63	IR	753 208 308	0.329	80	85	25	25	5.1	3.6
	90	75	IR	753 208 309	0.339	80	85	25	25	5.1	4.3
*	110	32	IR	753 208 310	0.643	90	95	30	25	6.3	2.9
	110	50	IR	753 208 311	0.655	90	95	30	25	6.3	2.9
	110	63	IR	753 208 312	0.516	90	95	30	25	6.3	3.6
	110	75	IR	753 208 313	0.521	90	95	30	25	6.3	4.3
	110	90	IR	753 208 314	0.529	90	95	30	25	6.3	5.1
	160	63	IR	753 208 321	2.103	142	135	50	30	9.1	3.6
	160	75	IR	753 208 322	2.142	142	135	50	30	9.1	4.3
	160	90	IR	753 208 323	1.668	142	135	50	30	9.1	5.1
	160	110	IR	753 208 324	1.687	142	135	50	30	9.1	6.3
	225	90	IR	753 208 338	3.439	155	165	40	30	12.8	5.1
	225	110	IR	753 208 339	3.448	155	165	40	30	12.8	6.3
	225	160	IR	753 208 341	3.471	155	165	40	30	12.8	9.1



ecoFIT tee 90° equal SDR17/17.6

Model:

- Material: PE100
- Conventional butt-welding according to DVS 2207
- IR = Infrared-(IR Plus) compatible. Choose fusion parameters: PE100

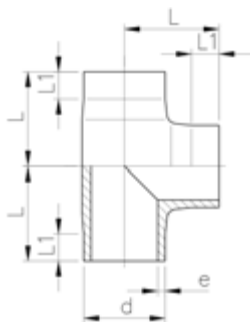

d	FM	Code	Weight	L	L1	e
(mm)			(kg)	(mm)	(mm)	(mm)
50	IR	753 208 535	0.080	59	26	2.9
63	IR	753 208 536	0.187	71	25	3.6
75	IR	753 208 412	0.232	74	20	4.8
90	IR	753 208 413	0.408	90	20	5.6
110	IR	753 208 414	0.724	110	20	6.9
125	IR	753 208 540	1.175	124	27	7.1
140	IR	753 208 541	1.623	141	33	8.0
160	IR	753 208 542	2.431	160	40	9.1
180	IR	753 208 543	3.756	190	70	10.2
200	IR	753 208 544	5.243	210	70	11.4
225	IR	753 208 545	6.030	248	80	12.8
250		753 208 546	9.964	272	90	14.2
280		753 208 547	14.265	313	108	15.9
315		753 208 548	22.284	348	114	17.9
355		753 208 524	21.800	345	105	21.1
400		753 208 525	28.600	365	105	23.7
450		753 208 526	42.400	425	135	26.7
500		753 208 527	57.600	470	155	29.7

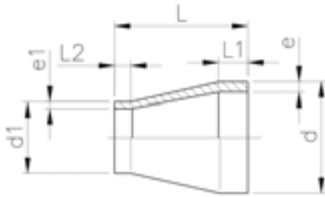

ecoFIT reducer SDR11

Model:

- Material: PE100
- Conventional butt-welding according to DVS 2207
- IR = Infrared-(IR Plus) compatible. Choose fusion parameters: PE100
- Up to d 315 injection moulded, above machined

d	d1	FM	Code	Weight	L	L1	L2	e	e1
(mm)	(mm)			(kg)	(mm)	(mm)	(mm)	(mm)	(mm)
25	20	IR	753 908 637	0.008	50	20	18	2.3	1,9
32	20	IR	753 908 642	0.010	50	20	18	2.9	1,9
32	25	IR	753 908 641	0.006	50	20	18	2.9	2,3
40	20	IR	753 908 648	0.017	58	20	20	3.7	1,9
40	25	IR	753 908 647	0.017	55	20	18	3.7	2,3
40	32	IR	753 908 646	0.019	55	20	18	3.7	2,9
50	25	IR	753 908 654	0.025	60	20	18	4.6	2,3
50	32	IR	753 908 653	0.026	60	20	18	4.6	2,9
50	40	IR	753 908 652	0.032	60	20	18	4.6	3,7
63	32	IR	753 908 660	0.046	65	20	18	5.8	2,9
63	40	IR	753 908 659	0.051	65	20	18	5.8	3,7
63	50	IR	753 908 658	0.056	65	20	18	5.8	4,6
75	40	IR	753 908 666	0.070	68	20	20	6.8	3,7
75	50	IR	753 908 665	0.074	65	20	18	6.8	4,6
75	63	IR	753 908 664	0.081	65	20	18	6.8	5,8
90	63	IR	753 908 671	0.125	75	21	17	8.2	5,8
90	75	IR	753 908 670	0.132	75	22	17	8.2	6,8
110	63	IR	753 908 672	0.219	90	28	28	10.6	6,2
110	75	IR	753 908 677	0.219	90	28	17	10.0	6,8
110	90	IR	753 908 676	0.240	90	28	20	10.0	8,2
125	110	IR	753 908 680	0.350	100	32	26	11.4	10,0
140	110	IR	753 908 685	0.437	110	35	28	12.7	10,0
140	125	IR	753 908 684	0.474	110	35	28	12.7	11,4
160	110	IR	753 908 690	0.612	120	40	25	14.6	10,0
160	140	IR	753 908 688	0.674	120	40	33	14.6	12,7
180	90	IR	753 908 877	0.678	157	45	22	16.4	8,2
180	110	IR	753 908 878	0.991	157	45	28	16.4	10,0
180	125	IR	753 908 879	0.528	136	45	32	16.4	11,4
180	140	IR	753 908 880	0.963	136	45	35	16.4	12,7
180	160	IR	753 908 881	1.094	136	45	40	16.4	14,6
200	160	IR	753 908 692	1.247	150	50	35	18.2	14,6
200	180	IR	753 908 883	1.419	151	50	45	18.2	16,4
225	110	IR	753 908 695	1.559	171	55	45	20.5	10,0
225	160	IR	753 908 696	1.590	160	55	37	20.5	14,6
225	180	IR	753 908 885	1.999	171	55	45	20.5	16,4
225	200	IR	753 908 697	1.844	160	55	48	20.5	18,2
250	160		753 908 890	2.416	194	60	40	22.7	14,6
250	180		753 900 001	2.513	175	60	55	22.7	16,4
250	200		753 900 002	2.450	180	60	60	22.7	18,2
250	225		753 908 887	2.766	182	60	55	22.7	20,5
280	200		753 900 004	3.540	205	70	50	25.4	18,2
280	225		753 908 892	1.943	105	30	20	25.4	20,5
280	250		753 908 891	1.802	70	30	18	25.4	22,7
315	200		753 900 007	3.996	225	80	50	28.6	20,5
315	225		753 908 897	3.491	130	30	30	28.6	20,5
315	250		753 908 896	2.379	100	30	20	28.6	22,7
315	280		753 908 895	1.684	63	30	18	28.6	25,4
355	225		753 900 011	4.700	245	90	55	32.3	20,5
355	250		753 900 012	4.400	245	90	60	32.3	22,7
355	280		753 900 013	4.100	245	90	70	32.3	25,4
355	315		753 900 014	3.700	245	90	80	32.3	28,6
400	225		753 900 015	7.963	260	95	60	36.4	20,5
400	250		753 900 016	6.800	260	95	70	36.4	22,7
400	280		753 900 017	6.200	260	95	70	36.4	25,4
400	315		753 900 018	10.829	260	95	80	36.4	28,6

table continued on the next page

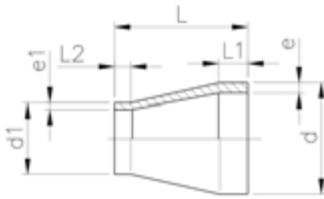

d	d1	FM	Code	Weight	L	L1	L2	e	e1
(mm)	(mm)			(kg)	(mm)	(mm)	(mm)	(mm)	(mm)
400	355		753 900 019	4.800	260	95	90	36.4	32,3
450	280		753 900 020	9.000	230	60	70	40.9	25,4
450	315		753 900 021	8.000	230	60	80	40.9	28,6
450	355		753 900 022	7.400	230	60	90	40.9	32,3
450	400		753 900 023	6.600	230	60	95	40.9	36,4
500	355		753 900 025	10.800	230	60	90	45.5	32,3
500	400		753 900 026	10.000	230	60	95	45.5	36,4
500	450		753 900 027	8.300	200	60	60	45.5	40,9
710	500		753 900 035	24.157	190	84	40	64.5	45,4
710	560		753 900 036	21.770	170	81	40	64.5	50,8
710	630		753 900 037	17.845	140	71	40	64.5	57,2



ecoFIT flush style reducer SDR11

Model:

- Material: PE100
- Flush style design
- Conventional butt-welding according to DVS 2207
- Clamping on welding machine needs to be done always on the bigger diameter (d1)
- The butt fusion machine must be suitable to weld both dimensions (d1 and d2)

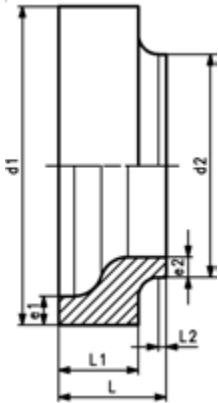

d1	d2	Code	Weight	L	L1	L2	e1	e2
(mm)	(mm)		(kg)	(mm)	(mm)	(mm)	(mm)	(mm)
355	225	753 909 809	5.230	130	95	10.0	32.2	20.5
355	250	753 909 810	3.752	115	80	10.0	32.3	22.7
355	280	753 909 811	4.066	115	80	10.0	32.3	25.4
355	315	753 909 812	4.149	115	80	15.0	32.3	28.6
400	225	753 909 816	7.964	145	110	10.0	36.3	20.5
400	250	753 909 817	6.861	135	100	10.0	36.4	22.7
400	280	753 909 818	6.679	135	100	10.0	36.4	25.4
400	315	753 909 819	6.460	135	100	10.0	36.4	28.6
400	355	753 909 820	6.101	135	100	13.0	36.4	32.3
450	225	753 909 822	11.965	165	125	10.0	40.9	20.5
450	250	753 909 823	11.087	160	120	10.0	40.9	22.7
450	280	753 909 824	9.604	150	100	15.0	40.9	25.4
450	315	753 909 825	9.091	150	100	15.0	40.9	28.6
450	355	753 909 826	8.656	150	100	15.0	40.9	32.3
450	400	753 909 827	8.369	150	100	15.0	40.9	36.4
500	225	753 909 829	16.053	180	130	10.0	45.4	20.5
500	250	753 909 830	15.784	180	130	10.0	45.4	22.7
500	280	753 909 831	14.691	175	125	10.0	45.4	25.4
500	315	753 909 832	10.921	165	115	10.0	45.5	28.6
500	355	753 909 833	11.321	165	115	10.0	45.5	32.3
500	400	753 909 834	12.453	165	115	10.0	45.5	36.4
500	450	753 909 835	12.640	165	115	25.0	45.5	40.9
560	315	753 909 836	22.204	210	160	10.0	50.8	28.6
560	355	753 909 837	19.976	200	150	10.0	50.8	32.2
560	400	753 909 838	17.215	185	135	10.0	50.8	36.3
560	450	753 909 839	14.263	165	115	10.0	50.8	40.9
560	500	753 909 840	13.955	165	115	10.0	50.8	45.4
630	315	753 909 841	29.984	220	170	10.0	57.2	28.6
630	355	753 909 842	29.376	220	170	10.0	57.2	32.2
630	400	753 909 843	26.541	210	160	10.0	57.2	36.3
630	450	753 909 844	23.034	195	145	10.0	57.2	40.9
630	500	753 909 845	19.243	175	125	10.0	57.2	45.4
630	560	753 909 846	17.438	165	115	20.0	57.2	50.8

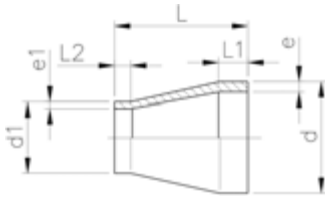

ecoFIT reducer SDR17/17.6

Model:

- Material: PE100
- Conventional butt-welding according to DVS 2207
- IR = Infrared-(IR Plus) compatible. Choose fusion parameters: PE100
- Up to d 315 injection moulded, above machined

d (mm)	d1 (mm)	FM	Code	Weight (kg)	L (mm)	L1 (mm)	L2 (mm)	e (mm)	e1 (mm)
50	40	IR	753 908 926	0.024	55	12	12	2.9	2,3
63	40	IR	753 908 927	0.036	65	16	12	3.6	2,3
63	50	IR	753 908 928	0.039	65	16	12	3.6	2,9
75	40	IR	753 908 904	0.041	71	19	12	4.3	2,3
75	50	IR	753 908 465	0.049	65	20	20	4.3	2,9
75	63	IR	753 908 464	0.056	65	20	20	4.3	3,6
90	63	IR	753 908 471	0.083	75	20	19	5.1	3,6
90	75	IR	753 908 470	0.092	75	20	20	5.1	4,3
110	63	IR	753 908 472	0.157	90	28	28	6.9	4,0
110	75	IR	753 908 477	0.157	89	28	18	6.3	4,3
110	90	IR	753 908 476	0.164	90	28	20	6.3	5,1
125	110	IR	753 908 912	0.272	108	32	28	7.1	6,3
140	110	IR	753 908 917	0.330	115	35	28	8.0	6,3
140	125	IR	753 908 916	0.374	115	35	32	8.0	7,1
160	110	IR	753 908 922	0.456	124	40	28	9.1	6,3
160	140	IR	753 908 920	0.499	124	40	35	9.1	8,0
180	90	IR	753 908 975	0.897	157	45	22	10.2	5,1
180	110	IR	753 908 976	0.690	157	45	28	10.2	6,3
180	125	IR	753 908 977	0.616	136	45	32	10.2	7,1
180	140	IR	753 908 978	0.647	136	45	35	10.2	8,0
180	160	IR	753 908 979	0.713	136	45	40	10.2	9,1
200	160	IR	753 908 931	0.860	145	50	40	11.4	9,1
200	180	IR	753 908 981	0.971	151	50	45	11.4	10,2
225	110	IR	753 908 938	1.382	160	55	35	12.8	6,3
225	160	IR	753 908 933	1.120	160	55	40	12.8	9,1
225	180	IR	753 908 985	1.364	171	55	45	12.8	10,2
225	200	IR	753 908 932	1.234	171	55	50	12.8	11,4
250	160		753 908 939	1.601	194	60	40	14.2	9,1
250	180		753 902 801	1.690	175	60	55	14.8	10,7
250	200		753 902 802	1.899	180	60	60	14.8	11,9
250	225		753 908 937	1.853	182	60	55	14.2	12,8
280	200		753 902 804	2.585	205	70	50	16.6	11,9
280	225		753 908 944	1.423	105	30	20	15.9	12,8
280	250		753 908 943	1.002	70	30	18	15.9	14,2
315	200		753 902 807	2.907	225	80	50	18.7	11,9
315	225		753 908 950	2.154	130	30	20	17.9	12,8
315	250		753 908 949	1.702	100	30	20	17.9	14,2
315	280		753 908 999	1.598	63	30	18	17.9	15,9
355	225		753 902 811	4.700	245	90	55	21.1	13,4
355	250		753 902 812	9.425	245	90	60	21.1	14,8
355	280		753 902 813	4.280	245	90	70	21.1	16,6
355	315		753 902 814	3.700	245	90	80	21.1	18,7
400	225		753 902 815	4.600	260	95	60	23.7	13,4
400	250		753 902 816	4.400	260	95	70	23.7	14,8
400	280		753 902 817	5.922	260	95	70	23.7	16,6
400	315		753 902 818	3.520	260	95	80	23.7	18,7
400	355		753 902 819	7.163	260	95	90	23.7	21,1
450	280		753 902 820	6.340	230	60	70	26.7	16,6
450	315		753 902 821	5.400	230	60	80	26.7	18,7
450	355		753 902 822	5.000	230	60	90	26.7	21,1
450	400		753 902 823	8.098	230	60	95	26.7	23,7
500	315		753 902 824	8.100	230	60	80	29.7	18,7
500	355		753 902 825	8.424	230	60	90	29.7	21,1
500	400		753 902 826	7.974	230	60	95	29.7	23,7
500	450		753 902 827	5.500	200	60	60	29.7	26,7

table continued on the next page

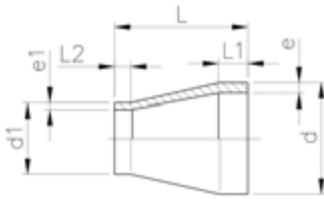

d (mm)	d1 (mm)	FM	Code	Weight (kg)	L (mm)	L1 (mm)	L2 (mm)	e (mm)	e1 (mm)
560	400		753 902 828	9.900	230	60	95	33.2	23,7
560	450		753 902 829	8.600	200	60	60	33.2	26,7
560	500		753 902 830	7.600	200	60	60	33.2	29,7
630	400		753 902 831	15.100	230	60	95	37.4	23,7
630	450		753 902 832	13.700	200	60	60	37.4	26,7
630	500		753 902 833	12.000	200	60	60	37.4	29,7
630	560		753 902 834	9.800	200	60	60	37.4	33,2
710	500		753 902 835	16.750	190	84	40	42.1	29,7
710	560		753 902 836	15.014	170	81	40	42.1	33,2
710	630		753 902 837	12.215	140	71	40	42.1	37,4
800	560		753 902 838	22.731	200	85	40	47.4	33,2
800	630		753 902 839	20.475	180	85	40	47.4	37,4
800	710		753 902 840	16.774	150	78	40	47.4	42,1
900	630		753 902 841	32.055	220	96	40	53.3	37,4
900	710		753 902 842	27.731	190	89	40	53.3	42,1
900	800		753 902 843	22.854	160	85	40	53.3	47,4
1000	710		753 902 844	40.412	220	91	40	59.3	42,1
1000	800		753 902 845	33.910	180	86	40	59.3	47,4
1000	900		753 902 846	25.824	140	75	40	59.3	53,3



ecoFIT flush style reducer SDR17/17.6

Model:

- Material: PE100
- Flush style design
- Conventional butt-welding according to DVS 2207
- Clamping on welding machine needs to be done always on the bigger diameter (d1)
- The butt fusion machine must be suitable to weld both dimensions (d1 and d2)

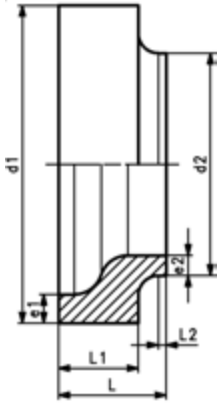

d1 (mm)	d2 (mm)	Code	Weight (kg)	L (mm)	L1 (mm)	L2 (mm)	e1 (mm)	e2 (mm)
355	225	753 909 859	3.922	120	85	10	21.1	13.4
355	250	753 909 860	3.318	115	80	10	21.1	14.8
355	280	753 909 861	3.134	115	80	10	21.1	16.6
355	315	753 909 862	2.716	115	80	15	21.1	18.7
400	225	753 909 866	6.299	135	100	10	23.7	13.4
400	250	753 909 867	5.754	135	100	10	23.7	14.8
400	280	753 909 868	5.468	135	100	10	23.7	16.6
400	315	753 909 869	5.125	135	100	10	23.7	18.7
400	355	753 909 870	4.614	135	100	13	23.7	21.1
450	225	753 909 872	9.323	150	110	10	26.7	13.4
450	250	753 909 873	9.000	150	110	10	27.7	14.8
450	280	753 909 874	8.066	150	110	15	26.7	16.6
450	315	753 909 875	7.354	150	110	15	26.7	18.7
450	355	753 909 876	6.724	150	110	15	26.7	21.1
450	400	753 909 877	6.238	150	110	15	26.7	23.7
500	225	753 909 879	12.120	165	115	10	29.7	13.4
500	250	753 909 880	11.834	165	115	10	29.7	14.8
500	280	753 909 881	11.459	165	115	10	29.7	16.6
500	315	753 909 882	10.502	165	115	10	29.7	18.7
500	355	753 909 883	10.154	165	115	10	29.7	21.1
500	400	753 909 884	8.642	165	115	10	29.7	23.7
500	450	753 909 885	7.978	165	115	25	29.7	26.7
560	315	753 909 886	19.966	210	160	10	33.2	18.7
560	355	753 909 887	17.764	200	150	10	33.2	21.1
560	400	753 909 888	15.168	185	135	10	33.2	23.7
560	450	753 909 889	11.650	165	115	10	33.2	26.7
560	500	753 909 890	10.623	165	115	20	33.2	29.7
630	315	753 909 891	27.625	220	170	10	37.4	18.7
630	355	753 909 892	26.454	220	170	10	37.4	21.1
630	400	753 909 893	23.648	210	160	10	37.4	23.7
630	450	753 909 894	19.957	195	145	10	37.4	26.7
630	500	753 909 895	15.910	175	125	10	37.4	29.7
630	560	753 909 896	13.272	165	115	20	37.4	33.2

Reducing Bushes excentric, PE100 SDR11

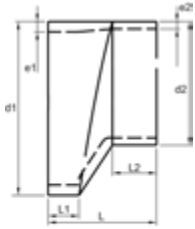

Model:

- Conventional butt fusion according to DVS2207
- Machined

d1 (mm)	d2 (mm)	PN (bar)	Code	L (mm)	L1 (mm)	L2 (mm)	e1 (mm)	e2 (mm)
63	50	16	700 647 600	120	35	35	5,8	4,6
75	50	16	700 647 601	120	40	35	6,8	4,6
75	63	16	700 647 602	120	40	35	6,8	5,8
90	63	16	700 647 603	140	50	50	8,2	5,8
90	75	16	700 647 604	140	50	50	8,2	6,8
110	75	16	700 647 605	140	50	50	10	6,8
110	90	16	700 647 606	140	50	50	10	8,2
125	90	16	700 647 607	140	50	50	11,4	5,1
125	110	16	700 647 608	140	50	50	11,4	10
140	90	16	700 647 609	140	50	50	12,7	8,2
140	110	16	700 647 610	140	50	50	12,7	10
160	90	16	700 647 611	140	50	54	14,6	8,2
160	110	16	700 647 612	120	40	45	14,6	10
160	125	16	700 647 613	110	40	44	14,6	11,4
160	140	16	700 647 614	90	40	33	14,6	12,7
180	125	16	700 647 615	130	40	52	16,4	11,4
180	140	16	700 647 616	110	40	41	16,4	12,7
180	160	16	700 647 617	90	40	33	16,4	16,4
200	140	16	700 647 618	140	40	50	18,2	12,7
200	160	16	700 647 619	120	40	41	18,2	14,6
200	180	16	700 647 620	100	40	43	18,2	16,4
225	160	16	700 647 621	140	40	57	20,5	14,6
225	180	16	700 647 622	120	40	48	20,5	16,4
225	200	16	700 647 623	100	40	40	20,5	18,2
250	180	16	700 647 624	150	40	54	22,7	16,4
250	200	16	700 647 625	130	40	55	22,7	18,2
250	225	16	700 647 626	110	40	40	22,7	20,5
280	200	16	700 647 627	160	40	58	25,4	18,2
280	225	16	700 647 628	130	40	52	25,4	20,5
280	250	16	700 647 629	110	40	47	25,4	22,7
315	225	16	700 647 630	160	40	62	28,6	20,5
315	250	16	700 647 631	140	40	57	28,6	22,7
315	280	16	700 647 632	120	40	54	28,6	25,4
355	250	16	700 647 633	180	40	74	32,2	22,7
355	250	16	700 647 634	150	40	61	32,2	25,4
355	315	16	700 647 635	120	40	51	32,2	28,6
400	280	16	700 647 636	200	40	85	36,3	25,4
400	315	16	700 647 637	170	40	75	36,3	28,6
400	355	16	700 647 638	130	40	58	36,3	32,2
450	315	16	700 647 639	210	40	86	40,9	28,6
450	355	16	700 647 640	180	40	79	40,9	32,2
450	400	16	700 647 641	140	40	65	40,9	36,3
500	315	16	700 647 642	260	40	107	45,4	28,6
500	355	16	700 647 643	220	40	91	45,4	32,2
500	400	16	700 647 644	190	40	86	45,4	36,3
500	450	16	700 647 645	140	40	65	45,4	40,9
560	450	16	700 647 646	200	40	91	50,8	40,9
560	500	16	700 647 647	150	40	70	50,8	45,4
630	500	16	700 647 648	220	40	99	57,2	45,4
630	560	16	700 647 649	170	40	84	57,2	50,8

Reducing Bushes excentric, PE100 SDR17.6

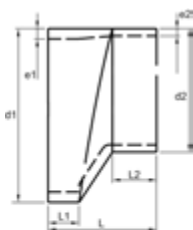

Model:

- Machined
- Conventional butt fusion according to DVS2207

d1 (mm)	d2 (mm)	PN (bar)	Code	L (mm)	L1 (mm)	L2 (mm)	e1 (mm)	e2 (mm)
63	50	10	700 647 650	120	35	35	3,6	2,9
75	50	10	700 647 651	120	40	35	4,3	2,9
75	63	10	700 647 652	120	40	35	4,3	3,6
90	63	10	700 647 653	140	50	50	5,1	3,6
90	75	10	700 647 654	140	50	50	5,1	4,3
110	75	10	700 647 655	140	50	50	6,3	4,3
110	90	10	700 647 656	140	50	50	6,3	5,1
125	90	10	700 647 657	140	50	50	7,1	5,1
125	110	10	700 647 658	140	50	50	7,1	6,3
140	90	10	700 647 659	140	50	50	8,0	5,1
140	110	10	700 647 660	140	50	50	8,0	6,3
160	90	10	700 647 661	140	50	54	9,5	5,4
160	110	10	700 647 662	120	40	45	9,5	6,6
160	125	10	700 647 663	110	40	44	9,5	7,4
160	140	10	700 647 664	90	40	33	9,5	8,3
180	125	10	700 647 665	130	40	52	10,7	7,4
180	140	10	700 647 666	110	40	41	10,7	8,3
180	160	10	700 647 667	90	40	33	10,7	9,5
200	140	10	700 647 668	140	40	50	11,9	8,3
200	160	10	700 647 669	120	40	41	11,9	9,5
200	180	10	700 647 670	100	40	43	11,9	10,7
225	160	10	700 647 671	140	40	57	13,4	9,5
225	180	10	700 647 672	120	40	48	13,4	10,7
225	200	10	700 647 673	100	40	40	13,4	11,9
250	180	10	700 647 674	150	40	54	14,8	10,7
250	200	10	700 647 675	130	40	55	14,8	11,9
250	225	10	700 647 676	110	40	40	14,8	13,4
280	200	10	700 647 677	160	40	58	16,6	11,9
280	225	10	700 647 678	130	40	52	16,6	13,4
280	250	10	700 647 679	110	40	47	16,6	14,8
315	225	10	700 647 680	160	40	62	18,7	13,4
315	250	10	700 647 681	140	40	57	18,7	14,8
315	280	10	700 647 682	120	40	54	18,7	16,6
355	250	10	700 647 683	180	40	74	21,1	14,8
355	280	10	700 647 684	150	40	61	21,1	16,6
355	315	10	700 647 685	120	40	51	21,1	18,7
400	280	10	700 647 686	200	40	85	23,7	16,6
400	315	10	700 647 687	170	40	75	23,7	18,7
400	355	10	700 647 688	130	40	58	23,7	21,1
450	315	10	700 647 689	210	40	86	26,7	18,7
450	355	10	700 647 690	180	40	79	26,7	21,1
450	400	10	700 647 691	140	40	65	26,7	23,7
500	315	10	700 647 692	260	40	107	29,7	18,7
500	355	10	700 647 693	220	40	91	29,7	21,1
500	400	10	700 647 694	190	40	86	29,7	23,7
500	450	10	700 647 695	140	40	65	29,7	26,7
560	450	10	700 647 696	200	40	91	33,2	26,7
560	500	10	700 647 697	150	40	70	33,2	29,7
630	500	10	700 647 698	220	40	99	37,4	29,7
630	560	10	700 647 699	170	40	84	37,4	33,2

End Cap PE100, SDR11

Model:

- Material: PE100
- Conventional butt fusion according to DVS2207
- Machined

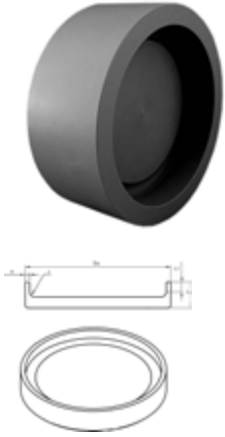

d (mm)	PN (bar)	Code	L1 (mm)	e (mm)	r (mm)	L (mm)
63	16	700 665 184	15	5.8	5	30
75	16	700 665 185	15	6.8	5	30
90	16	700 665 186	15	8.2	5	30
110	16	700 665 187	15	10.0	5	30
125	16	700 665 188	15	11.4	5	35
140	16	700 665 189	15	12.7	5	40
160	16	700 665 190	15	14.6	6	40
180	16	700 665 191	15	16.4	6	45
200	16	700 665 192	15	18.2	6	50
225	16	700 665 193	15	20.5	8	50
250	16	700 665 194	15	22.7	8	55
280	16	700 665 195	15	25.4	8	60
315	16	700 665 196	15	28.6	8	65
355	16	700 665 197	15	32.2	8	70
400	16	700 665 198	15	36.3	10	75
450	16	700 665 199	15	40.9	10	80
500	16	700 665 200	14	45.4	10	90
560	16	700 665 201	14	50.8	10	100
630	16	700 665 202	15	57.2	10	110

End Cap PE100, SDR17.6

Model:

- Material: PE100
- Conventional butt fusion according to DVS2207
- Machined

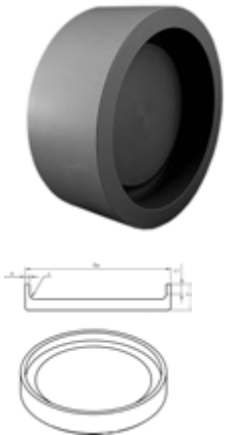

d (mm)	PN (bar)	Code	L (mm)	L1 (mm)	r (mm)	e (mm)
63	10	700 665 260	30	15	5	3.6
75	10	700 665 261	30	15	5	4.3
90	10	700 665 262	30	15	5	5.1
110	10	700 665 263	30	15	5	6.3
125	10	700 665 264	30	15	5	7.1
140	10	700 665 265	30	15	5	8.0
160	10	700 665 266	35	15	6	9.1
180	10	700 665 267	40	15	6	10.2
200	10	700 665 268	40	15	6	11.4
225	10	700 665 269	45	15	8	12.8
250	10	700 665 270	45	15	8	14.2
280	10	700 665 271	45	15	8	15.9
315	10	700 665 272	55	15	8	17.9
355	10	700 665 273	55	15	8	20.1
400	10	700 665 274	60	15	10	22.7
450	10	700 665 275	70	15	10	26.7
500	10	700 665 276	75	14	10	29.7
560	10	700 665 277	80	14	10	33.2
630	10	700 665 278	90	15	10	37.4

ecoFIT adaptor fittings for butt fusion

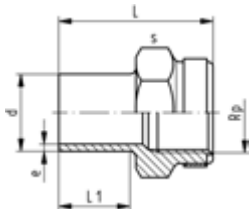

ecoFIT adaptor socket SDR11 metric Rp

Model:

- Material: PE100
- With butt fusion spigot **SDR11** and BSP parallel female thread Rp, reinforced
- Reinforcing ring stainless (A2)
- Connection to plastic or metal threads
- Do not use thread sealing pastes that are harmful to PE
- Install with low mechanical stress and avoid large cyclic temperature changes

d	DN	Rp	FM	PN	Code	Weight	L	L1	s	e
(mm)	(mm)	(inch)		(bar)		(kg)	(mm)	(mm)	(mm)	(mm)
20	15	½	IR	16	753 910 266	0.018	49	23	32	1.9
25	20	¾	IR	16	753 910 267	0.022	51	23	36	2.3
32	25	1	IR	16	753 910 268	0.038	55	23	46	3.0
40	32	1 ¼	IR	16	753 910 269	0.068	57	23	55	3.7
50	40	1 ½	IR	16	753 910 270	0.083	60	23	64	4.6
63	50	2	IR	16	753 910 271	0.134	62	23	80	5.8

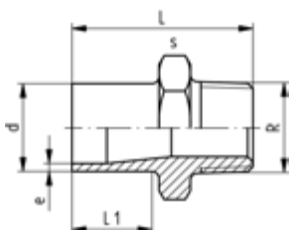

ecoFIT adaptor nipple SDR11 metric R

Model:

- Material: PE100
- With butt fusion spigot SDR11 and tapered male thread
- Do not use thread sealing pastes that are harmful to PE
- Install with low mechanical stress and avoid large cyclic temperature changes

d	R	DN	FM	Code	Weight	L	L1	s	e
(mm)	(inch)	(mm)			(kg)	(mm)	(mm)	(mm)	(mm)
20	½	15	IR	753 910 556	0.013	51	23	32	1.9
25	¾	20	IR	753 910 557	0.026	52	23	36	2.3
32	1	25	IR	753 910 558	0.028	55	23	46	3.0
40	1 ¼	32	IR	753 910 559	0.043	58	23	55	3.7
50	1 ½	40	IR	753 910 560	0.063	60	23	65	4.6
63	2	50	IR	753 910 561	0.104	67	26	80	5.8

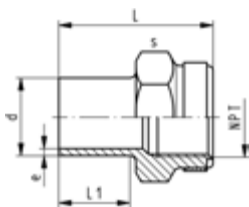

ecoFIT adaptor socket SDR11 metric NPT

Model:

- Material: PE100
- Conventional butt-welding according to DVS 2207
- IR = Infrared-(IR Plus) compatible. Choose fusion parameters: PE100
- NPT tapered female thread to ASTM F 1498
- Reinforcing ring stainless (A2)
- Connection to plastic or metal threads
- Do not use thread sealing pastes that are harmful to PE
- Install with low mechanical stress and avoid large cyclic temperature changes

d	NPT	FM	Code	Weight	L	L1	s	e
(mm)	(inch)			(kg)	(mm)	(mm)	(mm)	(mm)
20	½	IR	753 914 266	0.018	48	23	32	1.9
25	¾	IR	753 914 267	0.022	50	23	36	2.3
32	1	IR	753 914 268	0.038	54	23	46	2.9
40	1 ¼	IR	753 914 269	0.058	56	23	55	3.7
50	1 ½	IR	753 914 270	0.083	60	23	65	4.6
63	2	IR	753 914 271	0.134	62	23	80	5.8

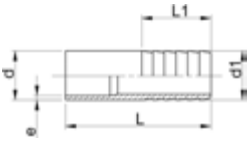

ecoFIT hose connector SDR11 metric

Model:

- Material: PE100
- With butt fusion spigot **SDR11** and parallel hose connection

d (mm)	d1 (mm)	DN (mm)	FM	Code	Weight (kg)	L (mm)	L1 (mm)	e (mm)
20	20	15	IR	753 968 606	0.007	64	27	1.9
25	25	20	IR	753 968 607	0.015	75	36	2.3
32	32	25	IR	753 968 608	0.023	82	36	2.9
40	40	32	IR	753 968 609	0.034	84	42	3.7
50	50	40	IR	753 968 610	0.057	90	48	4.6
63	60	50	IR	753 968 611	0.095	100	50	5.8

ecoFIT installation fittings

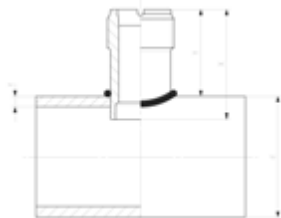
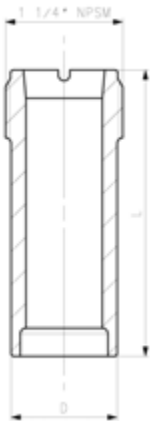

ecoFIT installation fitting type 314

Model:

- Material: PE100
- Threaded outlet 1 1/4" NPSM
- For conventional hot gas back welding according to DVS 2207 part 3

Attention:

- pH sensors can also be used for dimensions above d180/DN150 and below d75/DN65 with 753 314 000. The length might have to be adjusted (sensor has to touch the medium)
- only for pressureless or low pressure application
- pressure rate depends on quality of hot gas back welding
- please consult the instruction manual
- Installation by trained and certified welders only
- sensor length depends on installation fitting

Range of use:

- Compatible Signet flow sensors: type 2551, 2537, 515, 8510, 2536, 8512
- Compatible Signet pH/ORP sensors: type 2724, 2725, 2726, 2734, 2736, 2735

d (mm)	DN	Code	Weight (kg)	D (mm)	L (mm)	Sensor Type
75 - 180	65 - 150	753 314 000	0.040	37	68	flow X0, pH XX
200 - 355	200 - 350	753 314 001	0.057	37	102	flow X1
400 - 630	350 - 600	753 314 002	0.934	37	178	flow X2

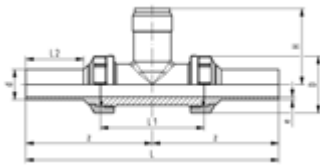

ecoFIT installation fitting type 318 SDR11 For butt fusion systems metric

Attention:

- sensor length depends on installation fitting

Model:

- Material: PE100
- Threaded outlet 1 ¼" NPSM
- Union end with butt fusion spigot PE100
- Body and union nut PP-H

Range of use:

- Compatible Signet pH/ORP sensors: type 2724, 2725, 2726, 2734, 2736, 2735
- Compatible Signet flow sensors: type 2551, 2537, 515, 8510, 2536, 8512

DN (mm)	PN (bar)	FM	d (mm)	EPDM Code	Weight (kg)	FKM Code
15	10	IR	20	753 318 006	0.136	753 318 036
20	10	IR	25	753 318 007	0.190	753 318 037
25	10	IR	32	753 318 008	0.250	753 318 038
32	10	IR	40	753 318 009	0.356	753 318 039
40	10	IR	50	753 318 010	0.510	753 318 040
50	10	IR	63	753 318 011	0.800	753 318 041

D (mm)	z (mm)	L (mm)	L1 (mm)	L2 (mm)	H (mm)	e (mm)	Sensor Type
48	112	224	90	52	76	1.9	flow X0, pH XX
58	121	242	100	53	78	2.3	flow X0, pH XX
65	128	256	110	55	81	2.9	flow X0, pH XX
79	136	272	110	60	85	3.7	flow X0, pH XX
91	147	294	120	66	89	4.6	flow X0, pH XX
105	158	316	130	70	95	5.8	flow X0, pH XX

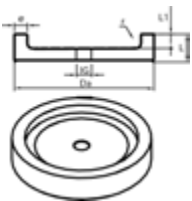

End Cap PE100, SDR17.6 with female thread

Model:

- Material: PE100
- Conventional butt fusion according to DVS2207
- Machined
- metric - Rp
- other thread-dimensions and NPT-thread available on request

d (mm)	Rp (inch)	PN (bar)	Code	r (mm)	L (mm)	L1 (mm)	e (mm)
63	½	10	700 665 279	5	30	15	3.6
75	½	10	700 665 280	5	30	15	4.3
90	½	10	700 665 281	5	30	15	5.1
110	½	10	700 665 282	5	30	15	6.3
125	½	10	700 665 283	5	30	15	7.1
140	½	10	700 665 284	5	30	15	8.0
160	½	10	700 665 285	6	35	15	9.1
180	½	10	700 665 286	6	40	15	10.2
200	½	10	700 665 287	6	40	15	11.4
225	½	10	700 665 288	8	45	15	12.8
250	½	10	700 665 289	8	45	15	14.2
280	½	10	700 665 290	8	45	15	15.9
315	½	10	700 665 291	8	55	15	17.9
355	½	10	700 665 292	8	55	15	20.1
400	½	10	700 665 293	10	60	15	22.7
450	½	10	700 665 294	10	70	15	26.7
500	½	10	700 665 295	10	75	14	29.7
560	½	10	700 665 296	10	80	14	33.2
630	½	10	700 665 297	10	90	15	37.2



End Cap PE100, SDR11 with female thread

Model:

- Material: PE100
- Conventional butt fusion according to DVS2207
- Machined
- metric - Rp
- other thread-dimensions and NPT-thread available on request

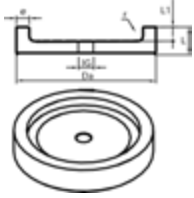

d (mm)	Rp (inch)	PN (bar)	Code	L (mm)	L1 (mm)	e (mm)	r (mm)
63	½	16	700 665 203	30	15	5.8	5
75	½	16	700 665 204	30	15	6.8	5
90	½	16	700 665 205	30	15	8.2	5
110	½	16	700 665 206	30	15	10.0	5
125	½	16	700 665 207	35	15	11.4	5
140	½	16	700 665 208	40	15	12.7	5
160	½	16	700 665 209	40	15	14.6	6
180	½	16	700 665 210	45	15	16.4	6
200	½	16	700 665 211	50	15	18.2	6
225	½	16	700 665 212	50	15	20.5	8
250	½	16	700 665 213	55	15	22.7	8
280	½	16	700 665 214	60	15	25.4	8
315	½	16	700 665 215	65	15	28.6	8
355	½	16	700 665 216	70	15	32.2	8
400	½	16	700 665 217	75	15	36.3	10
450	½	16	700 665 218	80	15	40.9	10
500	½	16	700 665 219	90	14	45.4	10
560	½	16	700 665 220	100	14	50.8	10
630	½	16	700 665 221	110	15	57.2	10



Instrument Installation Fittings PE, SDR17.6 with female thread

Model:

- Material: PE100
- Conventional butt fusion according to DVS2207
- Machined
- metric - Rp
- other thread-dimensions and NPT-thread available on request

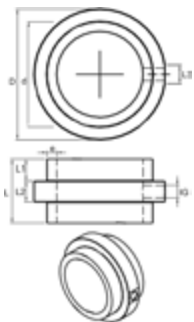

d (mm)	Rp (inch)	PN (bar)	Code	D (mm)	L (mm)	L1 (mm)	L2 (mm)	e (mm)
63	½	10	700 665 462	90	90	30	30	3.6
75	½	10	700 665 463	110	90	30	30	4.3
90	½	10	700 665 464	125	100	30	40	5.1
110	½	10	700 665 465	140	100	30	40	6.3
125	½	10	700 665 466	160	110	35	40	7.1
140	½	10	700 665 467	180	125	40	45	8.0
160	½	10	700 665 468	200	125	40	45	9.1
180	½	10	700 665 469	225	135	45	45	10.2
200	½	10	700 665 470	250	135	45	45	11.4
225	½	10	700 665 471	280	135	45	45	12.8
250	½	10	700 665 472	280	145	50	45	14.2
280	½	10	700 665 473	315	155	50	55	15.9
315	½	10	700 665 474	355	155	50	55	17.9
355	½	10	700 665 475	400	115	30	55	20.1
400	½	10	700 665 476	450	130	30	70	22.7



Instrument Installation Fittings PE, SDR11 with female thread

Model:

- Material: PE100
- Conventional butt fusion according to DVS2207
- Machined
- metric - Rp
- other thread-dimensions and NPT-thread available on request

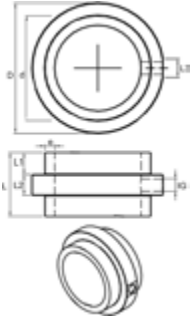

d	Rp	PN	Code	D	L	L1	L2	e
(mm)	(inch)	(bar)		(mm)	(mm)	(mm)	(mm)	(mm)
63	½	16	700 665 425	90	90	30	30	5.8
75	½	16	700 665 426	110	90	30	30	6.8
90	½	16	700 665 427	125	100	30	40	8.2
110	½	16	700 665 428	140	100	30	40	10.0
125	½	16	700 665 429	160	110	35	40	11.4
140	½	16	700 665 430	180	125	40	45	12.7
160	½	16	700 665 431	200	125	40	45	14.6
180	½	16	700 665 432	225	135	45	45	16.4
200	½	16	700 665 433	250	135	45	45	18.2
225	½	16	700 665 434	280	135	45	45	20.5
250	½	16	700 665 435	280	145	50	45	22.7
280	½	16	700 665 436	315	155	50	55	25.4
315	½	16	700 665 437	355	155	50	55	28.6
355	½	16	700 665 438	400	115	30	55	32.2
400	½	16	700 665 439	450	130	30	70	36.3

Unions



ecoFIT union SDR11

Model:

- Material: PE100
- Conventional butt-welding according to DVS 2207
- IR = Infrared- (IR Plus) compatible.
- Gasket: O-ring EPDM
- **For the dimensions d75-110 please see instructions for the installation**

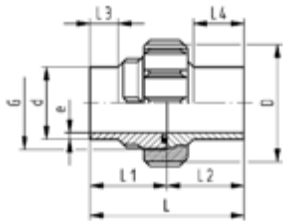

d	PN	FM	EPDM Code	Weight (kg)	FKM Code	Weight (kg)
(mm)	(bar)					
20	16	IR	753 518 606	0.048	753 528 606	0.042
25	16	IR	753 518 607	0.078	753 528 607	0.052
32	16	IR	753 518 608	0.108	753 528 608	0.083
40	16	IR	753 518 609	0.176	753 528 609	0.151
50	16	IR	753 518 610	0.241	753 528 610	0.196
63	16	IR	753 518 611	0.402	753 528 611	0.406
75	10	IR	753 518 612	0.537	753 528 612	0.520
90	10	IR	753 518 613	0.540	753 528 613	0.562
110	10	IR	753 518 614	0.783	753 528 614	0.760

d	D	G	L	L1	L2	L3	L4	e
(mm)	(mm)	(inch)	(mm)	(mm)	(mm)	(mm)	(mm)	(mm)
20	48	1	107	54.0	53	26	38	1.9
25	58	1 1/4	113	57.0	56	26	42	2.3
32	65	1 1/2	119	60.0	59	25	41	3.0
40	79	2	126	63.0	63	25	42	3.7
50	91	2 1/4	131	65.0	65	25	44	4.6
63	111	2 3/4	137	69.0	68	25	45	5.8
75	135	S107,5x3,6	132	66.0	66	24	34	6.8
90	135	S107,5x3,6	131	65.5	66	24	45	8.2
110	158	S127,5x3,6	131	65.5	66	25	40	10.0

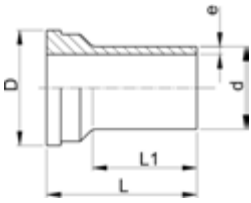

ecoFIT union end S5/SDR11

Model:

- Material: PE100
- IR = Infrared- (IR Plus) compatible.
- **For the dimensions d75-110 please see instructions for the installation**
- Conventional butt-welding according to DVS 2207

d (mm)	PN (bar)	FM	Code	Weight (kg)	D (mm)	L (mm)	L1 (mm)	e (mm)
20	16	IR	753 508 606	0.011	30	54	38	1.9
25	16	IR	753 508 607	0.018	39	57	42	2.3
32	16	IR	753 508 608	0.027	45	60	41	2.9
40	16	IR	753 508 609	0.044	57	63	42	3.7
50	16	IR	753 508 610	0.061	63	66	44	4.6
63	16	IR	753 508 611	0.100	78	69	45	5.8
75	10	IR	753 608 612	0.147	101	66	34	6.8
90	10	IR	753 608 613	0.156	101	66	55	8.2
110	10	IR	753 608 614	0.226	121	66	55	10.0

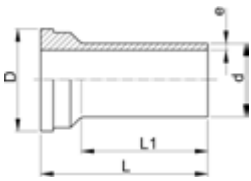

ecoFIT Union end long SDR11

Model:

- Material: PE100
- Suitable for unions, tank connectors and diaphragm valves Type 514
- For butt-, IR Plus® and electrofusion

d (mm)	PN (bar)	FM	Code	Weight (kg)	D (mm)	L (mm)	L1 (mm)	e (mm)
20	16	IR	753 508 616	0.006	30	67	52	1.9
25	16	IR	753 508 617	0.019	39	71	53	2.3
32	16	IR	753 508 618	0.027	45	73	55	2.9
40	16	IR	753 508 619	0.048	57	81	60	3.7
50	16	IR	753 508 620	0.069	63	87	66	4.6
63	16	IR	753 508 621	0.120	78	93	70	5.8

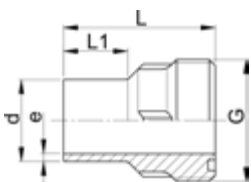

ecoFIT union bush SDR11

Model:

- Material: PE100
- Conventional butt-welding according to DVS 2207
- IR = Infrared- (IR Plus) compatible.
- Gasket: O-ring EPDM
- **For the dimensions d75-110 please see instructions for the installation**

d (mm)	PN (bar)	FM	Code	Weight (kg)	G (inch)	L (mm)	L1 (mm)	e (mm)
20	16	IR	753 648 606	0.016	1	54	26	1.9
25	16	IR	753 648 607	0.025	1 1/4	57	26	2.3
32	16	IR	753 648 608	0.035	1 1/2	60	25	2.9
40	16	IR	753 648 609	0.057	2	63	25	3.7
50	16	IR	753 648 610	0.077	2 1/4	66	25	4.6
63	16	IR	753 648 611	0.128	2 3/4	69	25	5.8
75	10	IR	753 648 612	0.181	S107,5x3,6	66	24	6.8
90	10	IR	753 648 613	0.192	S107,5x3,6	66	24	8.2
110	10	IR	753 648 614	0.272	S127,5x3,6	66	25	10.0

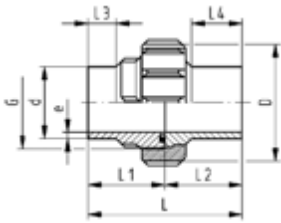

ecoFIT union SDR17.6

Model:

- Material: PE100
- Conventional butt-welding according to DVS 2207
- Gasket: O-ring EPDM
- **For the dimensions d75-110 please see instructions for the installation**
- IR = Infrared- (IR Plus) compatible.

d (mm)	PN (bar)	FM	EPDM Code	FKM Code	Weight (kg)	D (mm)	G (inch)	L (mm)	L1 (mm)	L2 (mm)	e (mm)
75	10	IR	753 518 412	753 528 412	0.476	135	S107,5x3,6	132	66	66	4.3
90	10	IR	753 518 413	753 528 413	0.483	135	S107,5x3,6	131	66	66	5.1
110	10	IR	753 518 414	753 528 414	0.663	158	S127,5x3,6	131	66	66	6.3

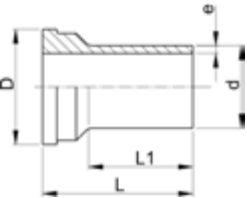

ecoFIT union end SDR17.6

Model:

- Material: PE100
- IR = Infrared- (IR Plus) compatible.
- **For the dimensions d75-110 please see instructions for the installation**
- Conventional butt-welding according to DVS 2207

d (mm)	PN (bar)	FM	Code	Weight (kg)	D (mm)	L (mm)	L1 (mm)	e (mm)
75	10	IR	753 608 412	0.124	101	66	34	4.3
90	10	IR	753 608 413	0.131	101	66	57	5.1
110	10	IR	753 608 414	0.178	121	66	55	6.3

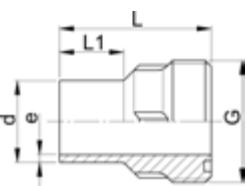

ecoFIT union bush SDR17.6

Model:

- Material: PE100
- Conventional butt-welding according to DVS 2207
- IR = Infrared- (IR Plus) compatible.
- **For the dimensions d75-110 please see instructions for the installation**

PN (bar)	d (mm)	FM	Code	Weight (kg)	G (inch)	L (mm)	L1 (mm)	e (mm)
10	75	IR	753 648 412	0.158	S107.5x3.6	66	24	4.3
10	90	IR	753 648 413	0.161	S107.5x3.6	66	24	5.1
10	110	IR	753 648 414	0.216	S127.5x3.6	66	25	6.3



ecoFIT union nut

Model:

- Material: PE-GF
- PE glass-fibre reinforced
- For the dimensions d75-110 please see instructions for the installation
- * PP glass fibre reinforced

	d-d (mm)	Code	Weight (kg)	G (inch)	D (mm)	L (mm)
	20	733 690 406	0.022	1	48	24
	25	733 690 407	0.036	1 1/4	58	26
	32	733 690 408	0.042	1 1/2	65	28
	40	733 690 409	0.068	2	79	31
	50	733 690 410	0.097	2 1/4	91	35
	63	733 690 411	0.164	2 3/4	111	39
*	75 - 90	727 690 442	0.202	S107,5x3,6	135	40
*	90 - 110	727 690 443	0.277	S127,5x3,6	158	43

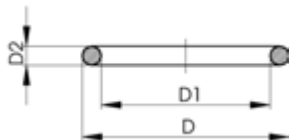

O-Ring gasket





Model:

- For unions and adaptor unions
- Hardness approx. 65° Shore
- EPDM minimum temperature -40°C
- FKM minimum temperature -15°C

* For unions PVC-U, PVC-C and ABS: 21 51 01, 21 51 11, 21 53 03, 21 53 08, 21 55 04, 21 55 13, 21 55 18, 23 51 01 and 29 51 01 only

	d (mm)	DN (mm)	EPDM Code	Weight (kg)	FKM Code	Weight (kg)	D (mm)	D1 (mm)	D2 (mm)	closest inch (inch)
	10 - 12	8	748 410 004	0.002	749 410 004	0.020	18	12	2.62	1/4
	16	10	748 410 005	0.004	749 410 005	0.002	21	16	2.62	3/8
	20	15	748 410 006	0.002	749 410 006	0.002	27	20	3.53	1/2
	25	20	748 410 007	0.002	749 410 007	0.002	35	28	3.53	3/4
	32	25	748 410 008	0.003	749 410 008	0.002	40	33	3.53	1
	40	32	748 410 009	0.003	749 410 009	0.007	51	41	5.34	1 1/4
	50	40	748 410 010	0.004	749 410 010	0.060	58	47	5.34	1 1/2
	63	50	748 410 011	0.005	749 410 011	0.003	70	60	5.34	2
	75	65	748 410 014	0.007	749 410 014	0.012	93	82	5.34	2 1/2
	90	80	748 410 015	0.008	749 410 015	0.015	112	101	5.34	3
*	90	80	748 410 248	0.008	749 410 248	0.020	105	95	5.34	3
	110	100	748 410 016	0.016	749 410 016	0.031	134	120	6.99	4

Valves with PE ends

Valves with PE ends		Page
	PVC-U body	131
	ABS body	148
	PP body	151
	Valve ends	166



PVC-U body



DN10/15 - 50

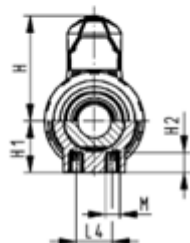
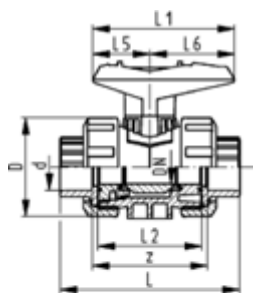

ecoFIT
Ball valve type 546
With mounting inserts
With fusion sockets PE100 metric

Model:

- Material: PVC-U/PE
- For easy installation and removal
- Ball seals PTFE
- Integrated stainless steel mounting inserts
- z-dimension, valve end and union nut are not compatible with type 346

Option:

- Individual configuration of the valve (see diagram)
- Multifunctional module with integrated limit switches
- Pneumatic or electric actuators from GF

d (mm)	DN (mm)	PN (bar)	kv-value ($\Delta p=1$ bar) (l/min)	EPDM Code	Weight (kg)	FKM Code	Weight (kg)
16	10	16	71	161 546 761	0.150	161 546 771	0.150
20	15	16	185	161 546 762	0.149	161 546 772	0.151
25	20	16	350	161 546 763	0.220	161 546 773	0.220
32	25	16	700	161 546 764	0.310	161 546 774	0.329
40	32	16	1000	161 546 765	0.550	161 546 775	0.550
50	40	16	1600	161 546 766	0.750	161 546 776	0.750
63	50	16	3100	161 546 767	1.360	161 546 777	1.360

d (mm)	D (mm)	H (mm)	H1 (mm)	H2 (mm)	L (mm)	L1 (mm)	L2 (mm)	L4 (mm)	L5 (mm)	L6 (mm)	M	z (mm)	closest inch (inch)
16	50	57	27	12	93	77	56	25	32	45	M6	67	3/8
20	50	57	27	12	95	77	56	25	32	45	M6	66	1/2
25	58	67	30	12	108	97	65	25	39	58	M6	77	3/4
32	68	73	36	12	119	97	71	25	39	58	M6	83	1
40	84	90	44	15	137	128	85	45	54	74	M8	99	1 1/4
50	97	97	51	15	147	128	89	45	54	74	M8	105	1 1/2
63	124	116	64	15	168	152	101	45	66	87	M8	113	2



DN10/15 - 50

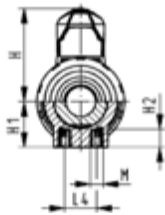
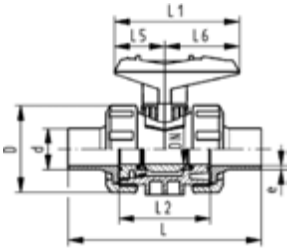

ecoFIT
Ball valve type 546
With mounting inserts
With butt fusion spigots PE100 SDR11 metric

Model:

- Material: PVC-U/PE
- For easy installation and removal
- Ball seals PTFE
- Integrated stainless steel mounting inserts
- z-dimension, valve end and union nut are not compatible with type 346

Option:

- Individual configuration of the valve (see diagram)
- Multifunctional module with integrated limit switches
- Pneumatic or electric actuators from GF

d (mm)	DN (mm)	PN (bar)	kv-value ($\Delta p=1$ bar) (l/min)	EPDM Code	Weight (kg)	FKM Code	Weight (kg)
20	15	16	185	161 546 782	0.151	161 546 792	0.153
25	20	16	350	161 546 783	0.231	161 546 793	0.220
32	25	16	700	161 546 784	0.329	161 546 794	0.333
40	32	16	1000	161 546 785	0.583	161 546 795	0.586
50	40	16	1600	161 546 786	0.817	161 546 796	0.826
63	50	16	3100	161 546 787	1.505	161 546 797	1.517

d (mm)	D (mm)	H (mm)	H1 (mm)	H2 (mm)	L (mm)	L1 (mm)	L2 (mm)	L4 (mm)	L5 (mm)	L6 (mm)	M	e (mm)	closest inch (inch)
20	50	57	27	12	130	77	56	25	32	45	M6	1.9	½
25	58	67	30	12	134	97	65	25	39	58	M6	2.3	¾
32	68	73	36	12	150	97	71	25	39	58	M6	2.9	1
40	84	90	44	15	171	128	85	45	54	74	M8	3.7	1 ¼
50	97	97	51	15	191	128	89	45	54	74	M8	4.6	1 ½
63	124	116	64	15	220	152	101	45	66	87	M8	5.8	2



DN10/15 - 50

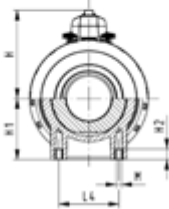
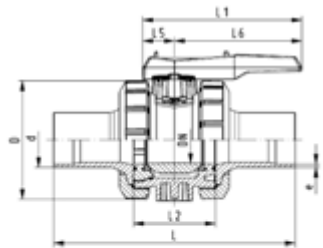
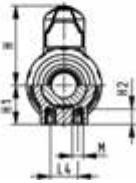
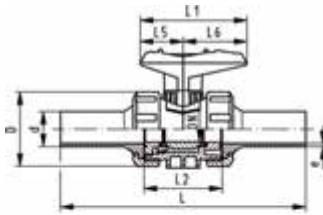

ecoFIT
Ball valve type 546
With mounting inserts
With butt fusion spigots long
PE100 SDR11 metric

Model:

- Material: PVC-U/PE
- For easy installation and removal
- Ball seals PTFE
- Integrated stainless steel mounting inserts
- Valve end and union nut are **not compatible** with type 346 (DN10/15-50) and type 370 (DN65-100)

Option:

- Individual configuration of the valve (see diagram)
- Multifunctional module with integrated limit switches
- Pneumatic or electric actuators from GF

d (mm)	DN (mm)	PN (bar)	kv-value ($\Delta p=1$ bar) (l/min)	EPDM Code	Weight (kg)	FKM Code	Weight (kg)
20	15	16	185	161 546 822	0.162	161 546 832	0.150
25	20	16	350	161 546 823	0.248	161 546 833	0.220
32	25	16	700	161 546 824	0.362	161 546 834	0.310
40	32	16	1000	161 546 825	0.550	161 546 835	0.550
50	40	16	1600	161 546 826	0.886	161 546 836	0.750
63	50	16	3100	161 546 827	1.630	161 546 837	1.360
75	65	16	5000	161 546 828	3.651	161 546 838	5.000
90	80	16	7000	161 546 829	6.840	161 546 839	7.500
110	100	16	11000	161 546 830	8.860	161 546 840	11.800

d (mm)	D (mm)	H (mm)	H1 (mm)	H2 (mm)	L (mm)	L1 (mm)	L2 (mm)	L4 (mm)	L5 (mm)	L6 (mm)	M	e (mm)	closest inch (inch)
20	50	57	27	12	193	77	56	25	32	45	M6	1.9	1/2
25	58	67	30	12	216	97	65	25	39	58	M6	2.3	3/4
32	68	73	36	12	223	97	71	25	39	58	M6	2.9	1
40	84	90	44	15	249	128	85	45	54	74	M8	3.7	1 1/4
50	97	97	51	15	271	128	89	45	54	74	M8	4.6	1 1/2
63	124	116	64	15	321	152	101	45	66	87	M8	5.8	2
75	166	149	85	15	386	270	136	70	64	206	M8	6.8	2 1/2
90	200	161	105	15	421	270	141	70	64	206	M8	8.2	3
110	238	178	123	22	484	320	164	120	64	256	M12	10.0	4



DN10/15 - 50

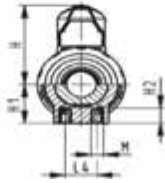
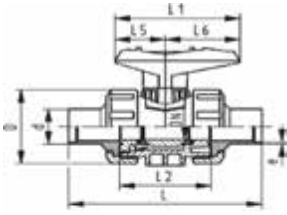

ecoFIT
Ball valve type 546
With mounting inserts
With butt fusion spigots PE100 SDR17.6 metric

Model:

- Material: PVC-U/PE
- For easy installation and removal
- Ball seals PTFE
- Integrated stainless steel mounting inserts
- z-dimension, valve end and union nut are not compatible with type 346

Option:

- Individual configuration of the valve (see diagram)
- Multifunctional module with integrated limit switches
- Pneumatic or electric actuators from GF

d (mm)	DN (mm)	PN (bar)	kv-value ($\Delta p=1$ bar) (l/min)	EPDM Code	Weight (kg)	FKM Code	Weight (kg)
40	32	10	1000	161 546 805	0.582	161 546 815	0.550
50	40	10	1600	161 546 806	0.750	161 546 816	0.750
63	50	10	3100	161 546 807	1.605	161 546 817	1.501

d (mm)	D (mm)	H (mm)	H1 (mm)	H2 (mm)	L (mm)	L1 (mm)	L2 (mm)	L4 (mm)	L5 (mm)	L6 (mm)	M	e (mm)	closest inch (inch)
40	84	90	44	15	171	128	85	45	54	74	M8	2.3	1 ¼
50	97	97	51	15	191	128	89	45	54	74	M8	2.9	1 ½
63	124	116	64	15	220	152	101	45	66	87	M8	3.6	2

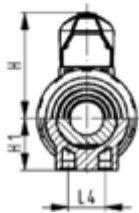
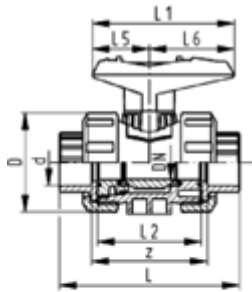

ecoFIT
Ball valve type 546
With fusion sockets PE100 metric

Model:

- Material: PVC-U/PE
- For easy installation and removal
- Ball seals PTFE
- Without mounting inserts
- z-dimension, valve end and union nut are not compatible with type 346

Option:

- Individual configuration of the valve (see diagram)
- Multifunctional module with integrated limit switches
- Pneumatic or electric actuators from GF

d (mm)	DN (mm)	PN (bar)	kv-value ($\Delta p=1$ bar) (l/min)	EPDM Code	Weight (kg)	FKM Code	Weight (kg)
16	10	16	71	800 000 101	0.160	800 000 111	0.170
20	15	16	185	800 000 102	0.170	800 000 112	0.170
25	20	16	350	800 000 103	0.240	800 000 113	0.240
32	25	16	700	800 000 104	0.350	800 000 114	0.340
40	32	16	1000	800 000 105	0.610	800 000 115	0.610
50	40	16	1600	800 000 106	0.840	800 000 116	0.850
63	50	16	3100	800 000 107	1.560	800 000 117	1.550

d (mm)	D (mm)	H (mm)	H1 (mm)	L (mm)	L1 (mm)	L2 (mm)	L4 (mm)	L5 (mm)	L6 (mm)	z (mm)	closest inch (inch)
16	50	57	27	93	77	56	25	32	45	67	¾
20	50	57	27	95	77	56	25	32	45	66	½
25	58	67	30	108	97	65	25	39	58	77	¾
32	68	73	36	119	97	71	25	39	58	83	1
40	84	90	44	137	128	85	45	54	74	99	1 ¼
50	97	97	51	147	128	89	45	54	74	105	1 ½
63	124	116	64	168	152	101	45	66	87	113	2

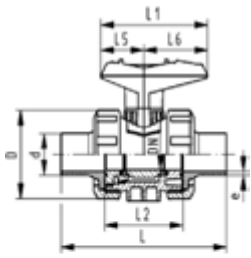

ecoFIT
Ball valve type 546
With butt fusion spigots PE100 SDR11 metric

Model:

- Material: PVC-U/PE
- For easy installation and removal
- Ball seals PTFE
- Without mounting inserts
- z-dimension, valve end and union nut are not compatible with type 346

Option:

- Individual configuration of the valve (see diagram)
- Multifunctional module with integrated limit switches
- Pneumatic or electric actuators from GF

d (mm)	DN (mm)	PN (bar)	kv-value ($\Delta p=1$ bar) (l/min)	EPDM Code	Weight (kg)	FKM Code	Weight (kg)
20	15	16	185	800 000 142	0.116	800 000 152	0.160
25	20	16	350	800 000 143	0.227	800 000 153	0.240
32	25	16	700	800 000 144	0.340	800 000 154	0.340
40	32	16	1000	800 000 145	0.600	800 000 155	0.600
50	40	16	1600	800 000 146	0.830	800 000 156	0.830
63	50	16	3100	800 000 147	1.560	800 000 157	1.560

d (mm)	D (mm)	H (mm)	H1 (mm)	L (mm)	L1 (mm)	L2 (mm)	L4 (mm)	L5 (mm)	L6 (mm)	e (mm)	closest inch (inch)
20	50	57	27	130	77	56	25	32	45	1.9	½
25	58	67	30	134	97	65	25	39	58	2.3	¾
32	68	73	36	150	97	71	25	39	58	3.0	1
40	84	90	44	171	128	85	45	54	74	3.7	1 ¼
50	97	97	51	191	128	89	45	54	74	4.6	1 ½
63	124	116	64	220	152	101	45	66	87	5.8	2

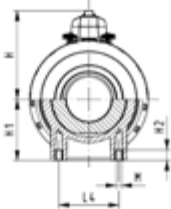
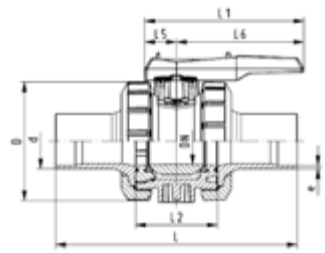
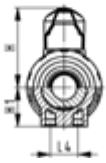
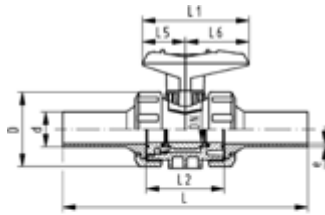

ecoFIT
Ball valve type 546
With butt fusion spigots long
PE100 SDR11 metric

Model:

- Material: PVC-U/PE
- For easy installation and removal
- Ball seals PTFE
- Without mounting inserts
- Valve end and union nut are **not compatible** with type 346 (DN10/15-50) and type 370 (DN65-100)

Option:

- Individual configuration of the valve (see diagram)
- Multifunctional module with integrated limit switches
- Pneumatic or electric actuators from GF

d (mm)	DN (mm)	kv-value ($\Delta p=1$ bar) (l/min)	PN (bar)	EPDM Code	FKM Code	Weight (kg)
20	15	185	16	800 000 282	800 000 292	0.170
25	20	350	16	800 000 283	800 000 293	0.250
32	25	700	16	800 000 284	800 000 294	0.370
40	32	1000	16	800 000 285	800 000 295	0.640
50	40	1600	16	800 000 286	800 000 296	0.910
63	50	3100	16	800 000 287	800 000 297	1.634
75	65	5000	16	800 000 288	800 000 298	5.000
90	80	7000	16	800 000 289	800 000 299	7.500
110	100	11000	16	800 000 290	800 000 300	11.800

d (mm)	D (mm)	H (mm)	H1 (mm)	L (mm)	L1 (mm)	L2 (mm)	L4 (mm)	L5 (mm)	L6 (mm)	e (mm)	closest inch (inch)
20	50	57	27	193	77	56	25	32	45	2.2	1/2
25	58	67	30	216	97	65	25	39	58	2.3	3/4
32	68	73	36	223	97	71	25	39	58	3.0	1
40	84	90	44	249	128	85	45	54	74	3.7	1 1/4
50	97	97	51	271	128	89	45	54	74	4.6	1 1/2
63	124	116	64	321	152	101	45	66	87	5.8	2
75	166	149	85	386	270	136	70	64	206	6.8	2 1/2
90	200	161	105	421	270	141	70	64	206	8.2	3
110	238	178	123	484	320	164	120	64	256	10.0	4

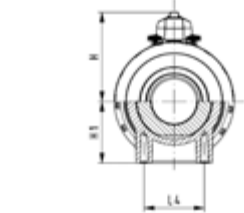
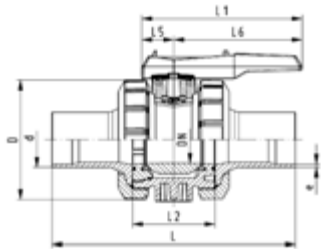

ecoFIT
Ball valve type 546
 With butt fusion spigots long
 PE100 SDR17.6 metric

Model:

- Material: PVC-U/PE
- For easy installation and removal
- Ball seals PTFE
- Without mounting inserts
- Valve end and union nut are **not compatible** with type 346 (DN10/15-50) and type 370 (DN65-100)
- Image and drawing DN65-100 please see "**New product ball valve DN65-100**"

Option:

- Individual configuration of the valve (see diagram)
- Multifunctional module with integrated limit switches
- Pneumatic or electric actuators from GF

d (mm)	DN (mm)	PN (bar)	kv-value ($\Delta p=1$ bar) (l/min)	EPDM Code	FKM Code	Weight (kg)
75	65	16	5000	800 000 218	800 000 228	5.000
90	80	16	7000	800 000 219	800 000 229	7.400
110	100	16	11000	800 000 220	800 000 230	11.700

d (mm)	D (mm)	H (mm)	H1 (mm)	L (mm)	L1 (mm)	L2 (mm)	L4 (mm)	L5 (mm)	L6 (mm)	e (mm)	closest inch (inch)
75	166	149	85	386	270	136	70	64	206	4.3	2 1/2
90	200	161	105	421	270	141	70	64	206	5.1	3
110	238	178	123	484	320	164	120	64	256	6.3	4



DN10/15 - 50

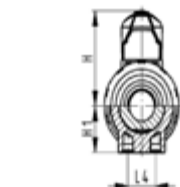
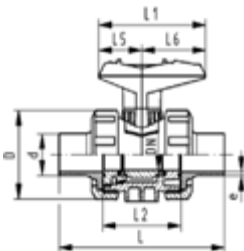

ecoFIT
Ball valve type 546
 With butt fusion spigots PE100 SDR17.6 metric

Model:

- Material: PVC-U/PE
- For easy installation and removal
- Ball seals PTFE
- Without mounting inserts
- z-dimension, valve end and union nut are not compatible with type 346

Option:

- Individual configuration of the valve (see diagram)
- Multifunctional module with integrated limit switches
- Pneumatic or electric actuators from GF

d (mm)	DN (mm)	PN (bar)	kv-value ($\Delta p=1$ bar) (l/min)	EPDM Code	Weight (kg)	FKM Code	Weight (kg)
40	32	10	1000	800 000 125	0.600	800 000 135	0.600
50	40	10	1600	800 000 126	0.830	800 000 136	0.830
63	50	10	3100	800 000 127	1.560	800 000 137	1.560

d (mm)	D (mm)	H (mm)	H1 (mm)	L (mm)	L1 (mm)	L2 (mm)	L4 (mm)	L5 (mm)	L6 (mm)	e (mm)	closest inch (inch)
40	84	90	44	171	128	85	45	54	74	2.3	1 1/4
50	97	97	51	191	128	89	45	54	74	2.9	1 1/2
63	124	116	64	220	152	101	45	66	87	3.6	2



ecoFIT
3-Way ball valve type 543
Horizontal/L-port
With butt fusion spigots long
PE100 SDR11 metric

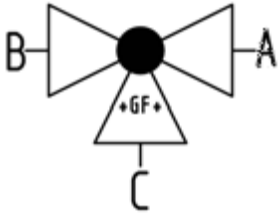

Model:

- Material: PVC-U/PE
- For easy installation and removal (valve end and union nut are compatible with type 546)
- Ball seals PTFE
- Pneumatic or electric actuator available separately
- Angle of operation 360° without turn limiter
- Turn limiter 90° enclosed, in different positions usable as a clip-on ring
- Integrated stainless steel mounting inserts
- Delivery status A-C opened, see flow scheme

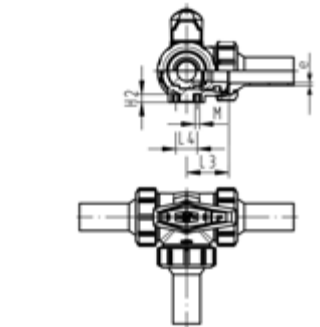
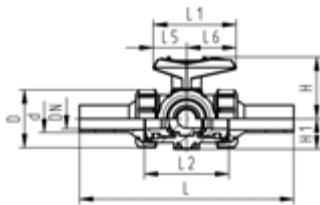
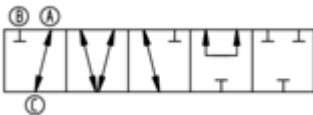

d (mm)	DN (mm)	PN (bar)	kv-value ($\Delta p=1$ bar) (l/min)	EPDM Code	Weight (kg)	FKM Code	Weight (kg)
20	15	10	75	161 543 462	0.254	161 543 472	0.254
25	20	10	150	161 543 463	0.370	161 543 473	0.370
32	25	10	280	161 543 464	0.563	161 543 474	0.563
40	32	10	480	161 543 465	0.953	161 543 475	0.953
50	40	10	620	161 543 466	1.444	161 543 476	1.444
63	50	10	1230	161 543 467	3.141	161 543 477	3.141

d (mm)	D (mm)	L (mm)	L1 (mm)	L2 (mm)	L3 (mm)	L4 (mm)	L5 (mm)	L6 (mm)	H (mm)	H1 (mm)	H2 (mm)	M (mm)	e (mm)	closest inch (inch)
20	50	210	77	73	36	25	32	45	57	28	8	6	1.9	½
25	58	237	97	86	43	25	39	58	67	32	8	6	2.3	¾
32	68	251	97	99	50	25	39	58	73	36	8	6	2.9	1
40	84	283	128	120	60	45	54	74	90	45	9	8	3.7	1 ¼
50	97	319	128	137	69	45	54	74	97	51	9	8	4.6	1 ½
63	124	399	152	179	89	45	66	87	116	65	9	8	5.8	2



ecoFIT
3-Way ball valve type 543
Horizontal/T-port
With butt fusion spigots long
PE100 SDR11 metric

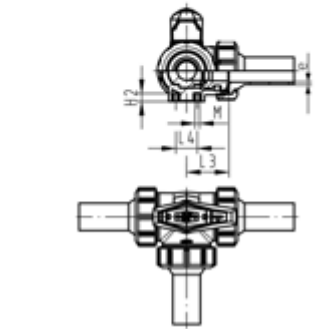
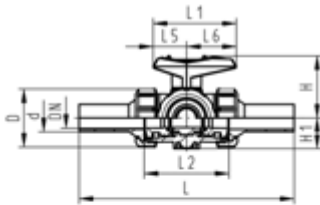
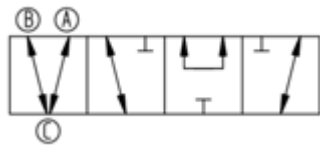
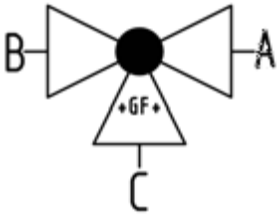

Model:

- Material: PVC-U/PE
- For easy installation and removal (valve end and union nut are compatible with type 546)
- Ball seals PTFE
- Pneumatic or electric actuator available separately
- Angle of operation 360° without turn limiter
- Turn limiter 90° enclosed, in different positions usable as a clip-on ring
- Integrated stainless steel mounting inserts
- Delivery status A-B-C opened, see flow scheme

d (mm)	DN (mm)	PN (bar)	kv-value ($\Delta p=1$ bar) (l/min)	EPDM Code	Weight (kg)	FKM Code	Weight (kg)
20	15	10	200	161 543 482	0.253	161 543 492	0.253
25	20	10	470	161 543 483	0.368	161 543 493	0.368
32	25	10	793	161 543 484	0.556	161 543 494	0.556
40	32	10	1290	161 543 485	0.942	161 543 495	0.942
50	40	10	1910	161 543 486	1.423	161 543 496	1.423
63	50	10	3100	161 543 487	2.770	161 543 497	3.096

d (mm)	D (mm)	L (mm)	L1 (mm)	L2 (mm)	L3 (mm)	L4 (mm)	L5 (mm)	L6 (mm)	H (mm)	H1 (mm)	H2 (mm)	M (mm)	e (mm)	closest inch (inch)
20	50	210	77	73	36	25	32	45	57	28	8	6	1.9	½
25	58	237	97	86	43	25	39	58	67	32	8	6	2.3	¾
32	68	251	97	99	50	25	39	58	73	36	8	6	2.9	1
40	84	283	128	120	60	45	54	74	90	45	9	8	3.7	1 ¼
50	97	319	128	137	69	45	54	74	97	51	9	8	4.6	1 ½
63	124	399	152	179	89	45	66	87	116	65	9	8	5.8	2

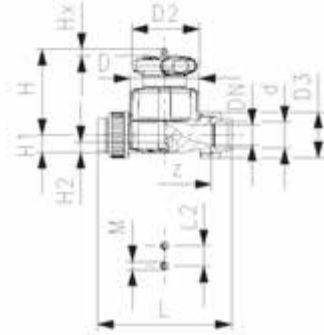

ecoFIT
Diaphragm valve type 514
With fusion sockets PE80 metric

Model:

- Material: PVC-U/PE
- Double flow rate compared to predecessor
- One housing nut replaces four screws
- Handwheel with built-in locking mechanism
- For easy installation and removal
- Short overall length

Option:

- Individual configuration of the valve (see diagram)
- Self adjusting multifunctional module with integrated limit switches
- PN16 available as a configuration

d (mm)	DN (mm)	PN (bar)	kv-value ($\Delta p=1$ bar) (l/min)	EPDM Code	Weight (kg)
20	15	10	125	161 514 212	0.290
25	20	10	271	161 514 213	0.416
32	25	10	481	161 514 214	0.662
40	32	10	759	161 514 215	1.405
50	40	10	1263	161 514 216	2.492
63	50	10	1728	161 514 217	3.331

d (mm)	D (mm)	D2 (mm)	D3 (mm)	L (mm)	L2 (mm)	H (mm)	H1 (mm)	H2 (mm)	M	z (mm)	Lift = Hx (mm)	closest inch (inch)
20	65	65	43	128	25	73	14	12	M6	100	7	½
25	80	65	51	150	25	81	18	12	M6	118	10	¾
32	88	87	58	162	25	107	22	12	M6	126	13	1
40	101	87	72	184	45	115	26	15	M8	144	15	1 ¼
50	117	135	83	210	45	148	32	15	M8	164	19	1 ½
63	144	135	100	248	45	166	39	15	M8	194	25	2



ecoFIT
Diaphragm valve type 514
 With butt and electro fusion ends PE100 SDR11 metric

Model:

- Material: PVC-U/PE
- Double flow rate compared to predecessor
- One housing nut replaces four screws
- Handwheel with built-in locking mechanism
- For easy installation and removal
- Short overall length

Option:

- Individual configuration of the valve (see diagram)
- Self adjusting multifunctional module with integrated limit switches
- PN16 available as a configuration

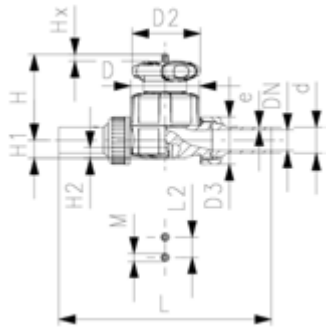

d (mm)	DN (mm)	PN (bar)	kv-value ($\Delta p=1$ bar) (l/min)	EPDM Code	Weight (kg)
20	15	10	125	161 514 312	0.357
25	20	10	271	161 514 313	0.431
32	25	10	481	161 514 314	0.683
40	32	10	759	161 514 315	1.443
50	40	10	1263	161 514 316	1.663
63	50	10	1728	161 514 317	2.568

d (mm)	D (mm)	D2 (mm)	D3 (mm)	L (mm)	L2 (mm)	H (mm)	H1 (mm)	H2 (mm)	M	Lift = Hx (mm)	e (mm)	closest inch (inch)
20	65	65	43	196	25	73	14	12	M6	7	1.9	½
25	80	65	51	221	25	81	18	12	M6	10	2.3	¾
32	88	87	58	234	25	107	22	12	M6	13	2.9	1
40	101	87	72	260	45	115	26	15	M8	15	3.7	1 ¼
50	117	135	83	284	45	148	32	15	M8	19	4.6	1 ½
63	144	135	100	321	45	166	39	15	M8	25	5.8	2



Butterfly valve type 567 PVC-U
Hand lever with ratchet settings

Model:

- Up to DN 300: Overall length according to EN558 (DN 50-200: line 25, DN250, 300 line 16), ISO 5752
- Connecting dimension: ISO 7005 PN 10, EN 1092 PN 10, DIN 2501 PN 10, ANSI/ASME B 16.5 Class 150, BS 1560: 1989, BS 4504, JIS B 2220
- We recommend for the dimensions DN250 and DN300 only 6 bar maximum system pressure for the hand lever version

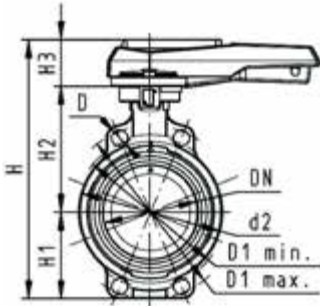

d (mm)	Size (inch)	DN (mm)	PN (bar)	kv-value ($\Delta p=1$ bar) (l/min)	EPDM Code	FKM Code	Weight (kg)
63	2	50	10	1470	161 567 002	161 567 022	1.259
75	2 ½	65	10	2200	161 567 003	161 567 023	1.799
90	3	80	10	3000	161 567 004	161 567 024	1.534
110	4	100	10	6500	161 567 005	161 567 025	2.235
140	5	125	10	11500	161 567 006	161 567 026	2.799
160	6	150	10	16600	161 567 007	161 567 027	3.791
225	8	200	10	39600	161 567 008	161 567 028	6.570
280	10	250	10	55200	161 567 009	161 567 029	12.998
315	12	300	10	80000	161 567 010	161 567 030	19.139

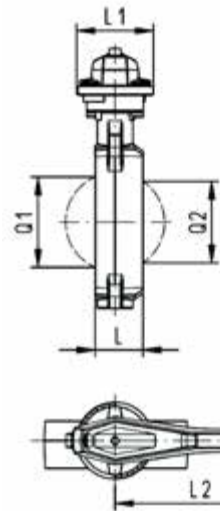

d (mm)	D (mm)	D1 min. (mm)	D1 max. (mm)	d2 (mm)	H (mm)	H1 (mm)	H2 (mm)	H3 (mm)	L (mm)	L1 (mm)	L2 (mm)	Q1 (mm)	Q2 (mm)
63	19	120.0	125.0	104	265	77	134	54	45	106	205	40	35
75	19	139.7	145.0	115	268	83	140	45	46	106	205	54	
90	19	150.0	160.0	131	289	89	146	54	49	106	205	67	50
110	19	175.0	190.5	161	326	104	167	55	56	106	255	88	74
140	23	210.0	215.9	187	353	117	181	55	64	106	255	113	97
160	24	241.3	241.3	215	374	130	189	55	72	106	255	139	123
225	23	290.0	295.0	267	435	158	210	67	73	140	408	178	169
280	25	353.0	362.0	329	554	205	264	85	113	149	408	210	207
315	25	400.0	432.0	379	598	228	285	85	113	149	408	256	253



Lugstyle butterfly valve type 578 PVC-U
Hand lever with ratchet settings

Model:

- Housing material: PP-GF30 with SS316 lug-inserts
- Overall length according to EN 558, ISO 5752 (DN50 - 200 line 25, DN250 - 300 line 10)
- Connecting dimension: ISO 7005 PN10, EN 1092 PN10, DIN 2501 PN10
- We recommend for the dimensions DN250 and DN300 only 6 bar maximum system pressure for the hand lever version

Option:

- Optional accessory: Valve-Integrated position feedback with limit switches (limit switches have to be ordered separately)

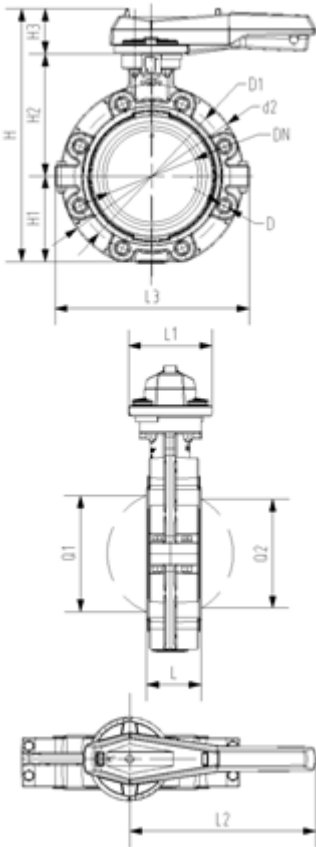

d	Size	DN	PN	kv-value	EPDM	Weight	FKM	Weight
(mm)	(inch)	(mm)	(bar)	($\Delta p=1$ bar)	Code	(kg)	Code	(kg)
				(l/min)				
63	2	50	10	1470	161 578 002	1.800	161 578 022	1.800
75	2 ½	65	10	2200	161 578 003	1.895	161 578 023	1.895
90	3	80	10	3000	161 578 004	2.251	161 578 024	2.251
110	4	100	10	6500	161 578 005	3.146	161 578 025	3.146
140	5	125	10	11500	161 578 006	4.660	161 578 026	4.660
160	6	150	10	16600	161 578 007	6.430	161 578 027	6.430
225	8	200	10	39600	161 578 008	8.625	161 578 028	8.625
280	10	250	10	55200	161 578 009	19.528	161 578 029	19.528
315	12	300	10	80000	161 578 010	26.106	161 578 030	26.106

d	d2	D	D1	D3	H	H1	H2	H3	L	L1	L2	L3	Q1	Q2
(mm)	(mm)		(mm)	(mm)	(mm)	(mm)	(mm)	(mm)	(mm)	(mm)	(mm)	(mm)	(mm)	(mm)
63	160	M16	125	27	265	77	134	62	45	78	112	179	40	
75	180	M16	145	27	277	83	140	62	46	78	112	179	54	35
90	195	M16	160	27	289	89	146	62	49	78	112	179	67	50
110	226	M16	180	27	328	106	167	62	56	78	112	179	88	74
140	258	M16	210	27	357	121	181	62	64	78	112	179	113	97
160	284	M20	240	27	377	133	189	62	72	78	112	179	139	123
225	341	M20	295	27	436	159	210	62	73	78	112	179	178	169
280	412	M20	350	200	536	205	264	69	113	97	130	198	210	207
315	482	M20	400	200	586	234	285	69	113	97	130	198	256	253

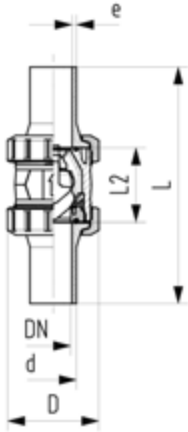

ecoFIT
Check valve type 561
With butt fusion spigots long
PE100 SDR11 metric

Model:

- Material: PVC-U/PE
- Designed for easy installation and removal
- Vibration free even at high flow velocity
- Flow-optimized return cone, double guided
- For vertical installation
- Compact installation length, same as ball valve type 546
- Z-length, end connectors and union nuts **not** compatible with type 360

d (mm)	DN (mm)	PN (bar)	kv-value ($\Delta p=1$ bar) (l/min)	EPDM Code	Weight (kg)	FKM Code	Weight (kg)
20	15	16	180	161 561 142	0.130	800 050 344	0.130
25	20	16	380	161 561 143	0.260	800 050 345	0.250
32	25	16	460	161 561 144	0.300	800 050 346	0.320
40	32	16	850	161 561 145	0.520	800 050 308	0.530
50	40	16	1080	161 561 146	0.780	800 050 347	0.810
63	50	16	1670	161 561 147	1.410	800 050 348	1.530
75	65	10	2950	161 561 148	3.260	800 050 837	3.160
90	80	10	3600	161 561 149	5.170	800 050 838	5.520
110	100	10	4150	161 561 150	8.310	800 050 839	8.930

d (mm)	D (mm)	L (mm)	L2 (mm)	e (mm)	closest inch (inch)
20	50	193	56	2.3	½
25	58	216	65	2.3	¾
32	68	223	71	3.0	1
40	84	249	85	3.7	1 ¼
50	97	271	89	4.6	1 ½
63	124	321	101	5.8	2
75	166	386	136		2 ½
90	200	421	141	8.2	3
110	238	484	164	10.0	4



ecoFIT
Check valve type 562
With butt fusion spigots long
PE100 SDR11 metric

Model:

- Material: PVC-U/PE
- For horizontal or vertical installation
- Spring loaded, spring made of stainless steel (1.4310)
- Spring available in other materials, see spare parts
- Designed for easy installation and removal
- Vibration free even at high flow velocity
- Flow-optimized return cone, double guided
- Compact installation length, same as ball valve type 546
- Z-length, end connectors and union nuts **not** compatible with type 360

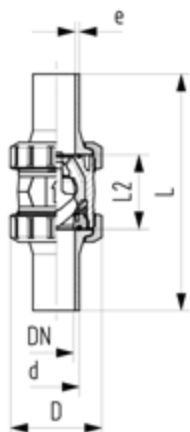

d	DN	PN	kv-value	EPDM	Weight	D	L	L2	e	closest
(mm)	(mm)	(bar)	($\Delta p=1$ bar)	Code	(kg)	(mm)	(mm)	(mm)	(mm)	inch
			(l/min)							(inch)
20	15	16	180	161 562 142	0.130	50	193	56	2.3	½
25	20	16	380	161 562 143	0.260	58	216	65	2.3	¾
32	25	16	460	161 562 144	0.300	68	223	71	3.0	1
40	32	16	850	161 562 145	0.520	84	249	85	3.7	1 ¼
50	40	16	1080	161 562 146	0.780	97	271	89	4.6	1 ½
63	50	16	1670	161 562 147	1.410	124	321	101	5.8	2
75	65	10	2950	161 562 148	3.260	166	386	136	6.8	2 ½
90	80	10	3600	161 562 149	5.170	200	421	141	8.2	3
110	100	16	4150	161 562 150	8.310	238	484	164	10.0	4



ecoFIT
Ventilating and bleed valve Type 591
With butt fusion spigots long
PE100 SDR11 metric

Model:

- Material: PVC-U/PE
- With protection cap up to DN50 made of PP-GF, DN65-100 made of POM
- Floater made of PP-H
- Designed for easy installation and removal
- Compact installation length

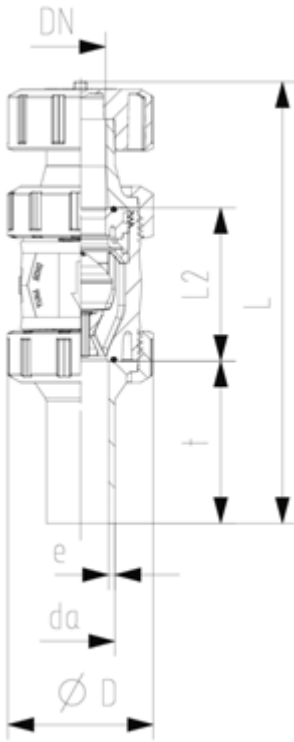

d	DN	PN	EPDM	FKM	D	L	L2	t	e	closest inch
(mm)	(mm)	(bar)	Code	Code	(mm)	(mm)	(mm)	(mm)	(mm)	(inch)
20	15	16	161 591 121	161 591 130	50	175	56	69	2.25	1/2
25	20	16	161 591 122	161 591 131	58	195	65	76	2.30	3/4
32	25	16	161 591 123	161 591 132	68	207	71	76	2.90	1
40	32	16	161 591 124	161 591 133	84	230	85	82	3.70	1 1/4
50	40	16	161 591 125	161 591 134	97	254	89	91	4.60	1 1/2
63	50	16	161 591 126	161 591 135	124	298	101	110	5.80	2
75	65	16	161 591 127	161 591 136	166	334	136	125	6.80	2 1/2
90	80	16	161 591 128	161 591 137	200	360	141	140	8.20	3
110	100	16	161 591 129	161 591 138	238	411	164	160	10.00	4

ABS body

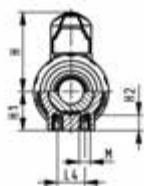
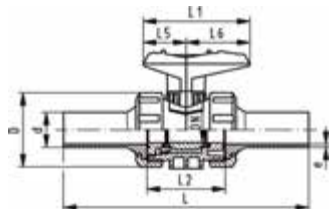

ecoFIT
Ball valve type 546
With mounting inserts
With butt fusion spigots long
PE100 SDR11 metric

Model:

- Material: ABS/PE
- For easy installation and removal
- Ball seals PTFE
- Integrated stainless steel mounting inserts
- Valve end and union nut are **not compatible** with type 346 (DN10/15-50) and type 370 (DN65-100)

Option:

- Individual configuration of the valve (see diagram)
- Multifunctional module with integrated limit switches
- Pneumatic or electric actuators from GF

d (mm)	DN (mm)	PN (bar)	kv-value ($\Delta p=1$ bar) (l/min)	EPDM Code	Weight (kg)
20	15	10	185	800 024 832	0.150
25	20	10	350	800 024 834	0.220
32	25	10	700	800 015 141	0.310
40	32	10	1000	800 015 142	0.530
50	40	10	1600	800 015 179	0.740
63	50	10	3100	800 015 143	1.370
75	65	10	5000	800 045 326	3.900
90	80	10	7000	800 045 327	3.900
110	100	10	11000	800 045 328	3.900

d (mm)	D (mm)	H (mm)	H1 (mm)	H2 (mm)	L (mm)	L1 (mm)	L2 (mm)	L4 (mm)	L5 (mm)	L6 (mm)	M	e (mm)	closest inch (inch)
20	50	57	27	12	193	77	56	25	32	45	M6	1.9	½
25	58	67	30	12	216	97	65	25	39	58	M6	2.3	¾
32	68	73	36	12	223	97	71	25	39	58	M6	2.9	1
40	84	90	44	15	249	128	85	45	54	74	M8	3.7	1 ¼
50	97	97	51	15	271	128	89	45	54	74	M8	4.6	1 ½
63	124	116	64	15	321	152	101	45	66	87	M8	5.8	2
75	166	149	85	15	386	270	136	70	64	206	M8	6.8	2 ½
90	200	161	105	15	421	270	141	70	64	206	M8	8.2	3
110	238	178	123	22	484	320	164	120	64	256	M12	10.0	4



ecoFIT
3-Way ball valve type 543
Horizontal/L-port
With butt fusion spigots long
PE100 SDR11 metric

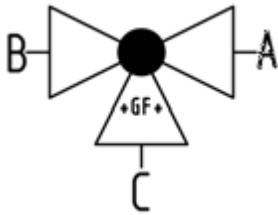

Model:

- Material: ABS/PE
- For easy installation and removal (valve end and union nut are compatible with type 546)
- Ball seals PTFE
- Pneumatic or electric actuator available separately
- Angle of operation 360° without turn limiter
- Turn limiter 90° enclosed, in different positions usable as a clip-on ring
- Integrated stainless steel mounting inserts
- Delivery status A-C opened, see flow scheme



d (mm)	DN (mm)	PN (bar)	kv-value ($\Delta p=1$ bar) (l/min)	EPDM Code	Weight (kg)
20	15	10	75	169 543 302	0.203
25	20	10	150	169 543 303	0.296
32	25	10	280	169 543 304	0.450
40	32	10	480	169 543 305	0.762
50	40	10	620	169 543 306	1.161
63	50	10	1230	169 543 307	2.509

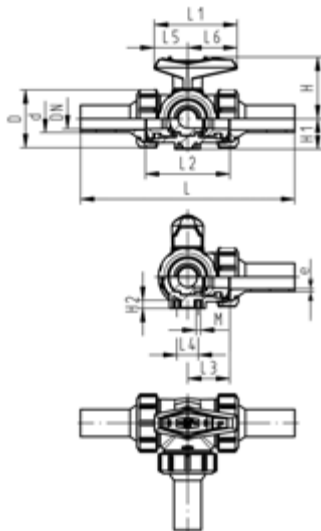

d (mm)	D (mm)	L (mm)	L1 (mm)	L2 (mm)	L3 (mm)	L4 (mm)	L5 (mm)	L6 (mm)	H (mm)	H1 (mm)	H2 (mm)	M	e (mm)	closest inch (inch)
20	50	210	77	73	36	25	32	45	57	28	8	6	2.3	1/2
25	58	237	97	86	43	25	39	58	67	32	8	6	2.3	3/4
32	68	251	97	99	50	25	39	58	73	36	8	6	2.9	1
40	84	283	128	120	60	45	54	74	90	45	9	8	3.7	1 1/4
50	97	319	128	137	69	45	54	74	97	51	9	8	4.6	1 1/2
63	124	399	152	179	89	45	66	87	116	65	9	8	5.8	2



ecoFIT
3-Way ball valve type 543
Horizontal/T-port
With butt fusion spigots long
PE100 SDR11 metric

Model:

- Material: ABS/PE
- For easy installation and removal (valve end and union nut are compatible with type 546)
- Ball seals PTFE
- Pneumatic or electric actuator available separately
- Angle of operation 360° without turn limiter
- Turn limiter 90° enclosed, in different positions usable as a clip-on ring
- Integrated stainless steel mounting inserts
- Delivery status A-B-C opened, see flow scheme

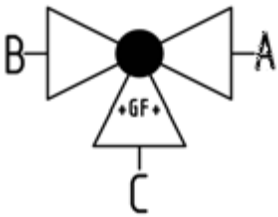
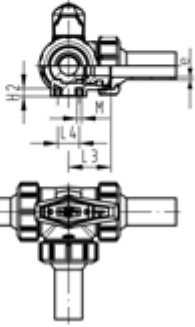
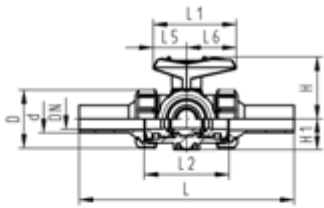

d (mm)	DN (mm)	PN (bar)	kv-value ($\Delta p=1$ bar) (l/min)	EPDM Code	Weight (kg)
20	15	10	200	169 543 322	0.203
25	20	10	470	169 543 323	0.296
32	25	10	793	169 543 324	0.450
40	32	10	1290	169 543 325	0.762
50	40	10	1910	169 543 326	1.161
63	50	10	3100	169 543 327	2.509

d (mm)	D (mm)	L (mm)	L1 (mm)	L2 (mm)	L3 (mm)	L4 (mm)	L5 (mm)	L6 (mm)	H (mm)	H1 (mm)	H2 (mm)	M (mm)	e (mm)	closest inch (inch)
20	50	210	77	73	36	25	32	45	57	28	8	6	1.9	½
25	58	237	97	86	43	25	39	58	67	32	8	6	2.3	¾
32	68	251	97	99	50	25	39	58	73	36	8	6	2.9	1
40	84	283	128	120	60	45	54	74	90	45	9	8	3.7	1 ¼
50	97	319	128	137	69	45	54	74	97	51	9	8	4.6	1 ½
63	124	399	152	179	89	45	66	87	116	65	9	8	5.8	2

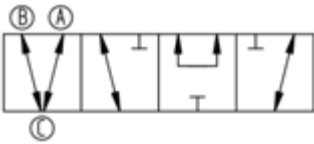

PP body



DN10/15 - 50

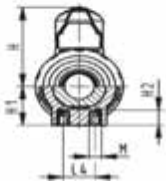
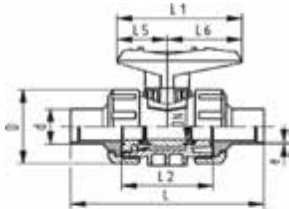

PROGEF
Ball valve type 546
With mounting inserts
With butt fusion spigots PE100 SDR11 metric

Model:

- Material: PP-H/PE
- For easy installation and removal
- Ball seals PTFE
- Integrated stainless steel mounting inserts
- z-dimension, valve end and union nut are not compatible with type 346

Option:

- Individual configuration of the valve (see diagram)
- Multifunctional module with integrated limit switches
- Pneumatic or electric actuators from GF

d (mm)	DN (mm)	PN (bar)	kv-value ($\Delta p=1$ bar) (l/min)	EPDM Code	Weight (kg)	FKM Code	Weight (kg)
20	15	10	185	167 546 142	0.120	167 546 152	0.120
25	20	10	350	167 546 143	0.184	167 546 153	0.180
32	25	10	700	167 546 144	0.262	167 546 154	0.255
40	32	10	1000	167 546 145	0.440	167 546 155	0.440
50	40	10	1600	167 546 146	0.637	167 546 156	0.620
63	50	10	3100	167 546 147	1.176	167 546 157	1.200

d (mm)	D (mm)	H (mm)	H1 (mm)	H2 (mm)	L (mm)	L1 (mm)	L2 (mm)	L4 (mm)	L5 (mm)	L6 (mm)	M	e (mm)	closest inch (inch)
20	50	57	27	12	130	77	56	25	32	45	M6	1.9	½
25	58	67	30	12	143	97	65	25	39	58	M6	2.3	¾
32	68	73	36	12	150	97	71	25	39	58	M6	2.9	1
40	84	90	44	15	171	128	85	45	54	74	M8	3.7	1 ¼
50	97	97	51	15	191	128	89	45	54	74	M8	4.6	1 ½
63	124	116	64	15	220	152	101	45	66	87	M8	5.8	2



DN10/15 - 50

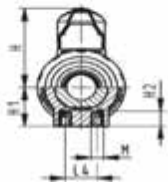
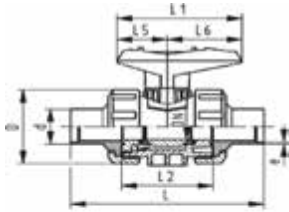

ecoFIT
Ball valve type 546
With mounting inserts
With butt fusion spigots PE100 SDR17.6 metric

Model:

- Material: PP-H/PE
- For easy installation and removal
- Ball seals PTFE
- Integrated stainless steel mounting inserts
- z-dimension, valve end and union nut are not compatible with type 346

Option:

- Individual configuration of the valve (see diagram)
- Multifunctional module with integrated limit switches
- Pneumatic or electric actuators from GF

d (mm)	DN (mm)	PN (bar)	kv-value ($\Delta p=1$ bar) (l/min)	EPDM Code	Weight (kg)	FKM Code	Weight (kg)
50	40	6	1600	167 546 126	0.620	167 546 136	0.620
63	50	6	3100	167 546 127	1.200	167 546 137	1.200

d (mm)	closest inch (inch)	D (mm)	H (mm)	H1 (mm)	H2 (mm)	L (mm)	L1 (mm)	L2 (mm)	L4 (mm)	L5 (mm)	L6 (mm)	M	e (mm)
50	1 ½	97	97	51	15	191	128	89	45	54	74	M8	2.9
63	2	124	116	64	15	220	152	101	45	66	87	M8	3.6



DN10/15 - 50

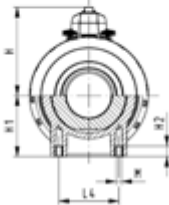
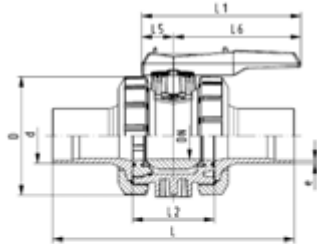
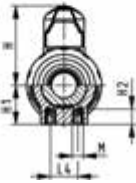
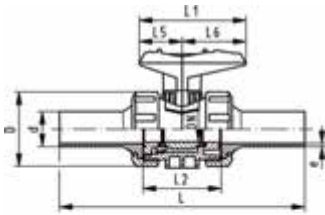

ecoFIT
Ball valve type 546
With mounting inserts
With butt fusion spigots long
PE100 SDR11 metric

Model:

- Material: PP-H/PE
- For easy installation and removal
- Ball seals PTFE
- Integrated stainless steel mounting inserts
- Valve end and union nut are **not compatible** with type 346 (DN10/15-50) and type 370 (DN65-100)

Option:

- Individual configuration of the valve (see diagram)
- Multifunctional module with integrated limit switches
- Pneumatic or electric actuators from GF

d (mm)	DN (mm)	PN (bar)	kv-value ($\Delta p=1$ bar) (l/min)	EPDM Code	Weight (kg)	FKM Code	Weight (kg)
20	15	10	185	167 546 282	0.131	167 546 292	0.130
25	20	10	350	167 546 283	0.195	167 546 293	0.195
32	25	10	700	167 546 284	0.285	167 546 294	0.280
40	32	10	1000	167 546 285	0.485	167 546 295	0.485
50	40	10	1600	167 546 286	0.703	167 546 296	0.695
63	50	10	3100	167 546 287	1.296	167 546 297	1.309
75	65	10	5000	167 546 288	2.788	167 546 298	3.900
90	80	10	7000	167 546 289	5.569	167 546 299	5.900
110	100	10	11000	167 546 290	9.300	167 546 300	9.300

d (mm)	D (mm)	H (mm)	H1 (mm)	H2 (mm)	L (mm)	L1 (mm)	L2 (mm)	L4 (mm)	L5 (mm)	L6 (mm)	M	e (mm)	closest inch (inch)
20	50	57	27	12	193	77	56	25	32	45	M6	1.9	½
25	58	67	30	12	216	97	65	25	39	58	M6	2.3	¾
32	68	73	36	12	223	97	71	25	39	58	M6	2.9	1
40	84	90	44	15	249	128	85	45	54	74	M8	3.7	1 ¼
50	97	97	51	15	271	128	89	45	54	74	M8	4.6	1 ½
63	124	116	64	15	321	152	101	45	66	87	M8	5.8	2
75	166	149	85	15	386	270	136	70	64	206	M8	6.8	2 ½
90	200	161	105	15	421	270	141	70	64	206	M8	8.2	3
110	238	178	123	22	484	320	164	120	64	256	M12	10.0	4



DN10/15 - 50

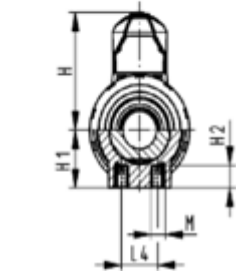
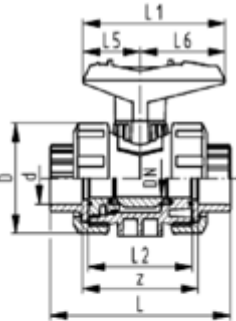

ecoFIT
Ball valve type 546
With mounting inserts
With fusion sockets PE100 metric

Model:

- Material: PP-H/PE
- For easy installation and removal
- Ball seals PTFE
- Integrated stainless steel mounting inserts
- z-dimension, valve end and union nut are not compatible with type 346

Option:

- Individual configuration of the valve (see diagram)
- Multifunctional module with integrated limit switches
- Pneumatic or electric actuators from GF

d (mm)	DN (mm)	PN (bar)	kv-value ($\Delta p=1$ bar) (l/min)	EPDM Code	Weight (kg)	FKM Code	Weight (kg)
16	10	10	71	167 546 161	0.120	167 546 171	0.120
20	15	10	185	167 546 162	0.120	167 546 172	0.120
25	20	10	350	167 546 163	0.180	167 546 173	0.180
32	25	10	700	167 546 164	0.258	167 546 174	0.260
40	32	10	1000	167 546 165	0.450	167 546 175	0.450
50	40	10	1600	167 546 166	0.630	167 546 176	0.630
63	50	10	3100	167 546 167	1.113	167 546 177	1.195

d (mm)	D (mm)	H (mm)	H1 (mm)	H2 (mm)	L (mm)	L1 (mm)	L2 (mm)	L4 (mm)	L5 (mm)	L6 (mm)	M	z (mm)	closest inch (inch)
16	50	57	27	12	93	77	56	25	32	45	M6	67	3/8
20	50	57	27	12	95	77	56	25	32	45	M6	67	1/2
25	58	67	30	12	109	97	65	25	39	58	M6	77	3/4
32	68	73	36	12	119	97	71	25	39	58	M6	83	1
40	84	90	44	15	135	128	85	45	54	74	M8	99	1 1/4
50	97	97	51	15	147	128	89	45	54	74	M8	105	1 1/2
63	124	116	64	15	168	152	101	45	66	87	M8	113	2

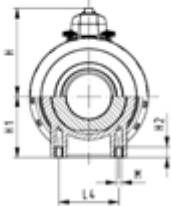
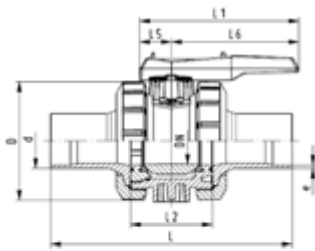

ecoFIT
Ball valve type 546
With mounting inserts
With butt fusion spigots long
PE100 SDR17,6 metric

Model:

- Material: PP-H/PE
- For easy installation and removal
- Ball seals PTFE
- Integrated stainless steel mounting inserts
- z-dimension, valve end and union nut are **not compatible** with type 370 (DN65-100)

Option:

- Individual configuration of the valve (see diagram)
- Multifunctional module with integrated limit switches
- Pneumatic or electric actuators from GF

d (mm)	DN (mm)	PN (bar)	kv-value ($\Delta p=1$ bar) (l/min)	EPDM Code	Weight (kg)	FKM Code	Weight (kg)
75	65	10	5000	167 546 308	3.003	167 546 318	3.900
90	80	10	7000	167 546 309	5.800	167 546 319	2.026
110	100	10	11000	167 546 310	9.200	167 546 320	9.200

d (mm)	D (mm)	H (mm)	H1 (mm)	H2 (mm)	L (mm)	L1 (mm)	L2 (mm)	L4 (mm)	L5 (mm)	L6 (mm)	M (mm)	e (mm)	closest inch (inch)
75	166	149	85	15	386	270	136	70	64	206	8	4.3	2 ½
90	200	161	105	15	421	270	141	70	64	206	8	5.1	3
110	238	178	123	22	484	320	164	120	64	256	12	6.3	4



ecoFIT
3-Way ball valve type 543
Horizontal/L-port
With butt fusion spigots long
PE100 SDR11 metric

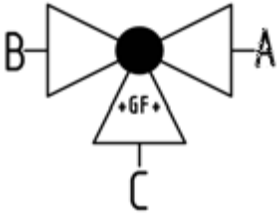

Model:

- Material: PP-H/PE
- For easy installation and removal (valve end and union nut are compatible with type 546)
- Ball seals PTFE
- Pneumatic or electric actuator available separately
- Angle of operation 360° without turn limiter
- Turn limiter 90° enclosed, in different positions usable as a clip-on ring
- Integrated stainless steel mounting inserts
- Delivery status A-C opened, see flow scheme

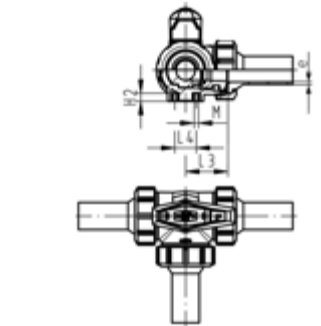
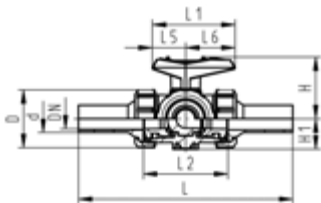

d (mm)	DN (mm)	PN (bar)	kv-value ($\Delta p=1$ bar) (l/min)	EPDM Code	Weight (kg)	FKM Code	Weight (kg)
20	15	10	75	167 543 122	0.179	167 543 132	0.179
25	20	10	150	167 543 123	0.262	167 543 133	0.262
32	25	10	280	167 543 124	0.399	167 543 134	0.399
40	32	10	480	167 543 125	0.675	167 543 135	0.675
50	40	10	620	167 543 126	1.032	167 543 136	1.032
63	50	10	1230	167 543 127	2.125	167 543 137	2.221

d (mm)	D (mm)	L (mm)	L1 (mm)	L2 (mm)	L3 (mm)	L4 (mm)	L5 (mm)	L6 (mm)	H (mm)	H1 (mm)	H2 (mm)	M (mm)	e (mm)	closest inch (inch)
20	50	210	77	72	36	25	32	45	57	28	8	6	1.9	½
25	58	237	97	85	43	25	39	58	67	32	8	6	2.3	¾
32	68	250	97	98	49	25	39	58	73	36	8	6	2.9	1
40	84	282	128	118	59	45	54	74	90	45	9	8	3.7	1 ¼
50	97	317	128	135	68	45	54	74	97	51	9	8	4.6	1 ½
63	124	396	152	176	88	45	66	87	116	65	9	8	5.8	2



ecoFIT
3-Way ball valve type 543
Horizontal/T-port
With butt fusion spigots long
PE100 SDR11 metric

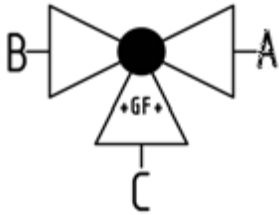

Model:

- Material: PP-H/PE
- For easy installation and removal (valve end and union nut are compatible with type 546)
- Ball seals PTFE
- Pneumatic or electric actuator available separately
- Angle of operation 360° without turn limiter
- Turn limiter 90° enclosed, in different positions usable as a clip-on ring
- Integrated stainless steel mounting inserts
- Delivery status A-B opened, see flow scheme

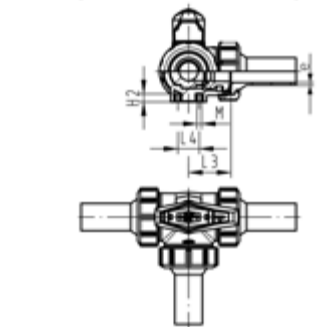
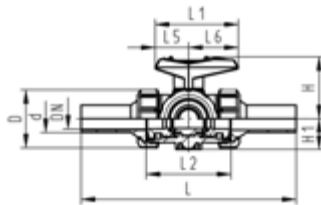
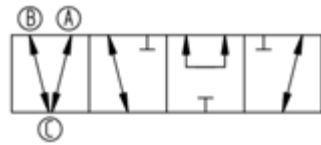

d	DN	PN	kv-value	EPDM	Weight	FKM	Weight
(mm)	(mm)	(bar)	($\Delta p=1$ bar)	Code	(kg)	Code	(kg)
			(l/min)				
20	15	10	200	167 543 322	0.179	167 543 332	0.179
25	20	10	470	167 543 323	0.261	167 543 333	0.261
32	25	10	793	167 543 324	0.395	167 543 334	0.395
40	32	10	1290	167 543 325	0.668	167 543 335	0.668
50	40	10	1910	167 543 326	1.019	167 543 336	1.019
63	50	10	3100	167 543 327	2.192	167 543 337	2.192

d	D	L	L1	L2	L3	L4	L5	L6	H	H1	H2	M	e	closest
(mm)	(mm)	(mm)	(mm)	(mm)	(mm)	(mm)	(mm)	(mm)	(mm)	(mm)	(mm)	(mm)	(mm)	inch
														(inch)
20	50	210	77	72	36	25	32	45	57	28	8	6	1.9	½
25	58	237	97	85	43	25	39	58	67	32	8	6	2.3	¾
32	68	250	97	98	49	25	39	58	73	36	8	6	2.9	1
40	84	282	128	118	59	45	54	74	90	45	9	8	3.7	1 ¼
50	97	317	128	135	68	45	54	74	97	51	9	8	4.6	1 ½
63	124	396	152	176	88	45	66	87	116	65	9	8	5.8	2



ecoFIT
Diaphragm valve type 514
With fusion sockets PE80 metric

Model:

- Material: PP-H/PE
- Double flow rate compared to predecessor
- One housing nut replaces four screws
- Handwheel with built-in locking mechanism
- For easy installation and removal
- Short overall length

Option:

- Individual configuration of the valve (see diagram)
- Self adjusting multifunctional module with integrated limit switches

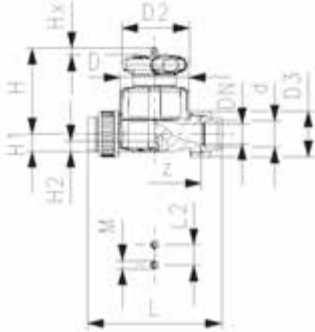

d (mm)	DN (mm)	PN (bar)	kv-value ($\Delta p=1$ bar) (l/min)	EPDM Code	Weight (kg)	PTFE/EPDM Code	Weight (kg)
20	15	10	125	167 514 212	0.263	167 514 232	0.371
25	20	10	271	167 514 213	0.490	167 514 233	0.502
32	25	10	481	167 514 214	1.083	167 514 234	1.103
40	32	10	759	167 514 215	1.279	167 514 235	1.299
50	40	10	1263	167 514 216	2.259	167 514 236	2.289
63	50	10	1728	167 514 217	2.950	167 514 237	2.978

d (mm)	D (mm)	D2 (mm)	D3 (mm)	L (mm)	L2 (mm)	H (mm)	H1 (mm)	H2 (mm)	M	z (mm)	Lift = Hx (mm)	closest inch (inch)
20	65	65	48	128	25	73	14	12	M6	100	7	½
25	80	65	58	150	25	81	18	12	M6	118	10	¾
32	88	87	65	162	25	107	22	12	M6	126	13	1
40	101	87	79	184	45	115	26	15	M8	144	15	1 ¼
50	117	135	91	210	45	148	32	15	M8	164	19	1 ½
63	144	135	111	248	45	166	39	15	M8	194	25	2

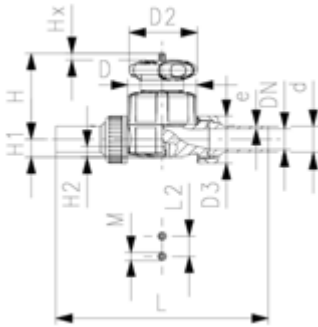

ecoFIT
Diaphragm valve type 514
With butt and electro fusion ends PE100 SDR11 metric

Model:

- Material: PP-H/PE
- Double flow rate compared to predecessor
- One housing nut replaces four screws
- Handwheel with built-in locking mechanism
- For easy installation and removal
- Short overall length

Option:

- Individual configuration of the valve (see diagram)
- Self adjusting multifunctional module with integrated limit switches

d (mm)	DN (mm)	PN (bar)	kv-value ($\Delta p=1$ bar) (l/min)	EPDM Code	Weight (kg)	PTFE/EPDM Code	Weight (kg)
20	15	10	125	167 514 312	0.372	167 514 332	0.381
25	20	10	271	167 514 313	0.502	167 514 333	0.514
32	25	10	481	167 514 314	0.636	167 514 334	1.127
40	32	10	759	167 514 315	0.950	167 514 335	1.337
50	40	10	1263	167 514 316	2.329	167 514 336	2.359
63	50	10	1728	167 514 317	2.167	167 514 337	3.088

d (mm)	D (mm)	D2 (mm)	D3 (mm)	L (mm)	L2 (mm)	H (mm)	H1 (mm)	H2 (mm)	M	Lift = Hx (mm)	e (mm)	closest inch (inch)
20	65	65	48	196	25	73	14	12	M6	7	1.9	½
25	80	65	58	221	25	81	18	12	M6	10	2.3	¾
32	88	87	65	234	25	107	22	12	M6	13	2.9	1
40	101	87	79	260	45	115	26	15	M8	15	3.7	1 ¼
50	117	135	91	284	45	148	32	15	M8	19	4.6	1 ½
63	144	135	111	321	45	166	39	15	M8	25	5.8	2



PROGEF Standard
Butterfly valve type 567
Hand lever with ratchet settings

Model:

- Material: PP-H, DN350-DN600 material PP-R
- Up to DN 300: Overall length according to EN558 (DN 50-200: line 25, DN250, 300 line 16), ISO 5752
- Connecting dimension: ISO 7005 PN 10, EN 1092 PN 10, DIN 2501 PN 10, ANSI/ASME B 16.5 Class 150, BS 1560: 1989, BS 4504, JIS B 2220
- We recommend for the dimensions DN250 and DN300 only 6 bar maximum system pressure for the hand lever version

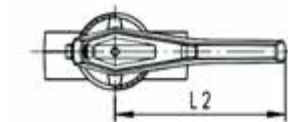
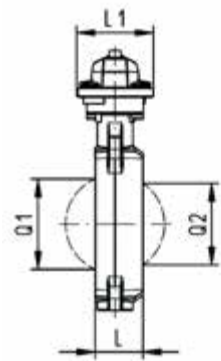
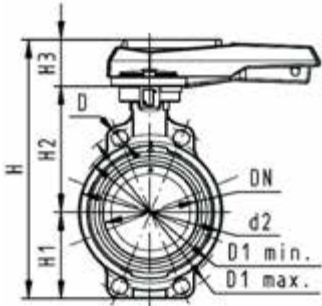

d (mm)	Size (inch)	DN (mm)	PN (bar)	kv-value ($\Delta p=1$ bar) (l/min)	EPDM Code	Weight (kg)	FKM Code	Weight (kg)
63	2	50	10	1470	167 567 002	1.170	167 567 022	1.627
75	2 ½	65	10	2200	167 567 003	1.254	167 567 023	1.061
90	3	80	10	3000	167 567 004	1.384	167 567 024	1.404
110	4	100	10	6500	167 567 005	1.961	167 567 025	1.998
140	5	125	10	11500	167 567 006	2.367	167 567 026	2.429
160	6	150	10	16600	167 567 007	3.741	167 567 027	3.246
225	8	200	10	39600	167 567 008	5.545	167 567 028	5.609
280	10	250	8	55200	167 567 009	11.061	167 567 029	11.841
315	12	300	8	80000	167 567 010	16.548	167 567 030	13.245

d (mm)	PTFE Code	Weight (kg)
63	167 567 202	1.170
75	167 567 203	1.254
90	167 567 204	1.384
110	167 567 205	1.961
140	167 567 206	2.367
160	167 567 207	3.741
225	167 567 208	5.545
280	167 567 209	11.061
315	167 567 210	16.548

d (mm)	d2 (mm)	D (mm)	D1 min. (mm)	D1 max. (mm)	H (mm)	H1 (mm)	H2 (mm)	H3 (mm)	L (mm)	L1 (mm)	L2 (mm)	Q1 (mm)	Q2 (mm)
63	104	19	120	125	264	77	134	54	45	106	205	40	
75	115	19	140	145	277	83	140	54	46	106	205	54	35
90	131	19	150	160	289	89	146	54	49	106	205	67	50
110	161	19	175	191	325	104	167	55	56	106	255	88	74
140	187	23	210	216	352	117	181	55	64	106	255	113	97
160	215	24	241	241	373	130	189	55	72	106	255	139	123
225	267	23	290	295	435	158	210	67	73	140	408	178	169
280	329	25	353	362	554	205	264	85	113	149	408	210	207
315	379	25	400	432	598	228	285	85	113	149	408	256	253



PROGEF Standard
Lugstyle butterfly valve type 578
Hand lever with ratchet settings

Model:

- Housing material: PP-GF30 with SS316 lug-inserts
- Overall length according to EN 558, ISO 5752 (DN50 - 200 line 25, DN250 - 300 line 10)
- Connecting dimension: ISO 7005 PN10, EN 1092 PN10, DIN 2501 PN10
- We recommend for the dimensions DN250 and DN300 only 6 bar maximum system pressure for the hand lever version

Option:

- Optional accessory: Valve-Integrated position feedback with limit switches (limit switches have to be ordered separately)

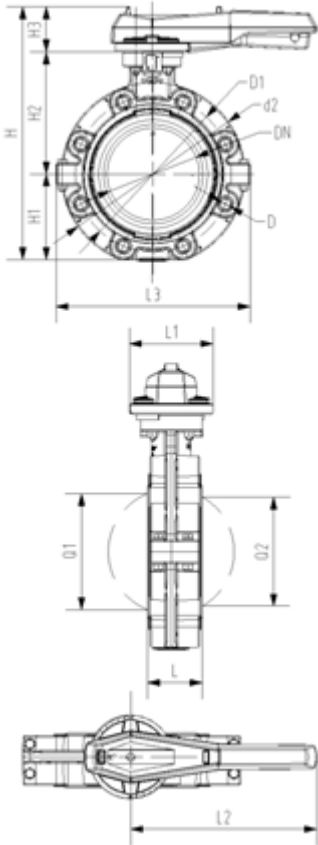

d	Size	DN	PN	kv-value	EPDM	Weight	FKM	Weight
(mm)	(inch)	(mm)	(bar)	($\Delta p=1$ bar)	Code	(kg)	Code	(kg)
				(l/min)				
63	2	50	10	1470	167 578 002	1.800	167 578 022	1.800
75	2 ½	65	10	2200	167 578 003	1.895	167 578 023	1.895
90	3	80	10	3000	167 578 004	2.251	167 578 024	2.251
110	4	100	10	6500	167 578 005	3.146	167 578 025	3.146
140	5	125	10	11500	167 578 006	4.660	167 578 026	4.660
160	6	150	10	16600	167 578 007	6.430	167 578 027	6.430
225	8	200	10	39600	167 578 008	8.625	167 578 028	8.625
280	10	250	8	55200	167 578 009	19.528	167 578 029	19.528
315	12	300	8	80000	167 578 010	26.106	167 578 030	26.106

d	d2	D	D1	H	H1	H2	H3	L	L1	L2	L3	Q1	Q2
(mm)	(mm)	(mm)	(mm)	(mm)	(mm)	(mm)	(mm)	(mm)	(mm)	(mm)	(mm)	(mm)	(mm)
63	160	M16	125	265	77	134	54	45	106	205	150	40	
75	180	M16	145	277	83	140	54	46	106	205	182	54	35
90	195	M16	160	289	89	146	54	49	106	205	210	67	50
110	226	M16	180	328	106	167	55	56	106	255	240	88	74
140	258	M16	210	357	121	181	55	64	106	255	272	113	97
160	284	M20	240	377	133	189	55	72	106	255	297	139	123
225	341	M20	295	436	159	210	67	73	140	408	360	178	169
280	412	M20	350	536	205	264	67	113	140	408	440	210	207
315	482	M20	400	586	234	285	67	113	140	408	510	256	253

ecoFIT
Check valve type 561
With butt fusion spigots long
PE100 SDR11 metric



Model:

- Material: PP-H/PE
- For vertical installation
- Ball is sealing at a minimum water column of 2 m
- Designed for easy installation and removal
- Vibration free even at high flow velocity
- Flow-optimized return cone, double guided
- Compact installation length, same as ball valve type 546
- Z-length, end connectors and union nuts **not** compatible with type 360

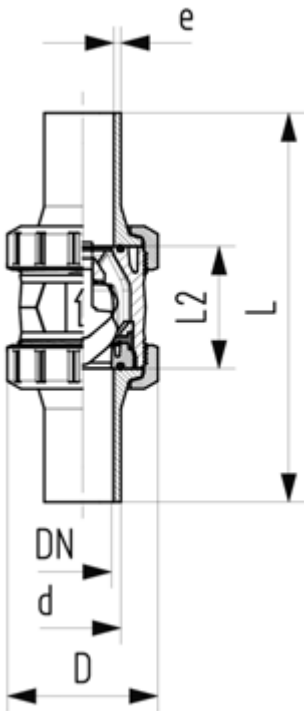

d (mm)	DN (mm)	PN (bar)	kv-value ($\Delta p=1$ bar) (l/min)	EPDM Code	Weight (kg)	FKM Code	Weight (kg)
20	15	10	180	167 561 282	0.090	167 561 292	0.090
25	20	10	380	167 561 283	0.190	167 561 293	0.200
32	25	10	460	167 561 284	0.210	167 561 294	0.220
40	32	10	850	167 561 285	0.380	167 561 295	0.380
50	40	10	1080	167 561 286	0.560	167 561 296	0.570
63	50	10	1670	167 561 287	1.126	167 561 297	1.060
75	65	10	2950	167 561 288	2.420		
90	80	10	3600	167 561 289	3.680		
110	100	10	4150	167 561 290	6.240		

d (mm)	D (mm)	L (mm)	L2 (mm)	e (mm)	closest inch (inch)
20	50	193	56	2.3	½
25	58	216	65	2.3	¾
32	68	223	71	3.0	1
40	84	249	85	3.7	1 ¼
50	97	271	89	4.6	1 ½
63	124	321	101	5.8	2
75	166	386	136	6.8	2 ½
90	200	421	141	8.2	3
110	238	484	164	10.0	4



ecoFIT
Check valve type 561
With butt fusion spigots
PE100 SDR17,6 metric

Model:

- Material: PP-H/PE
- For vertical installation
- Designed for easy installation and removal
- Vibration free even at high flow velocity
- Flow-optimized return cone, double guided
- Compact installation length, same as ball valve type 546
- Z-length, end connectors and union nuts **not** compatible with type 360

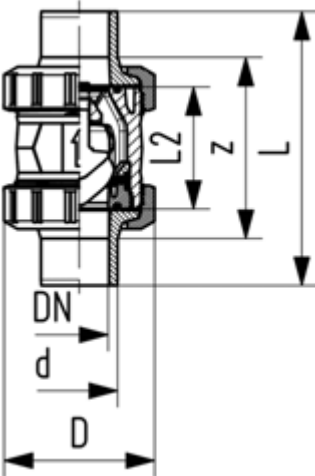

d (mm)	DN (mm)	PN (bar)	kv-value ($\Delta p=1$ bar) (L/min)	EPDM Code	Weight (kg)	FKM Code	Weight (kg)
50	40	10	1080	167 561 266	0.510	167 561 276	0.510
63	50	10	1670	167 561 267	0.940	167 561 277	0.940

d (mm)	D (mm)	L (mm)	L2 (mm)	e (mm)	closest inch (inch)
50	97	191	89	3	1 ½
63	124	220	101	4	2



ecoFIT
Check valve type 562
With butt fusion spigots long
PE100 SDR11 metric

Model:

- Material: PP-H/PE
- For horizontal or vertical installation
- Spring loaded, spring made of stainless steel (1.4310)
- Spring available in other materials, see spare parts
- Designed for easy installation and removal
- Vibration free even at high flow velocity
- Flow-optimized return cone, double guided
- Compact installation length, same as ball valve type 546
- Z-length, end connectors and union nuts **not** compatible with type 360

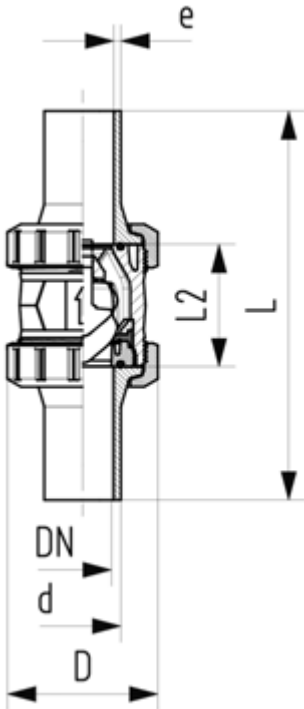

d (mm)	DN (mm)	PN (bar)	kv-value ($\Delta p=1$ bar) (l/min)	EPDM Code	Weight (kg)	FKM Code	Weight (kg)
20	15	10	180	167 562 282	0.090	167 562 292	0.090
25	20	10	380	167 562 283	0.190	167 562 293	0.200
32	25	10	460	167 562 284	0.210	167 562 294	0.220
40	32	10	850	167 562 285	0.380	167 562 295	0.380
50	40	10	1080	167 562 286	0.560	167 562 296	0.570
63	50	10	1670	167 562 287	1.050	167 562 297	1.060

d (mm)	D (mm)	L (mm)	L2 (mm)	e (mm)	closest inch (inch)
20	50	193	56	2.3	½
25	58	216	65	2.3	¾
32	68	223	71	3.0	1
40	84	249	85	3.7	1 ¼
50	97	271	89	4.6	1 ½
63	124	321	101	5.8	2



ecoFIT
Check valve type 562
With butt fusion spigots
PE100 SDR17,6 metric

Model:

- Material: PP-H/PE
- For horizontal or vertical installation
- Spring loaded, spring made of stainless steel (1.4310)
- Spring available in other materials, see spare parts
- Designed for easy installation and removal
- Vibration free even at high flow velocity
- Flow-optimized return cone, double guided
- Compact installation length, same as ball valve type 546
- Z-length, end connectors and union nuts **not** compatible with type 360

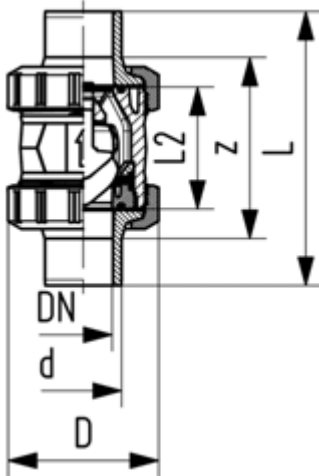

d (mm)	DN (mm)	PN (bar)	kv-value ($\Delta p=1$ bar) (l/min)	EPDM Code	Weight (kg)	FKM Code	Weight (kg)
50	40	10	1080	167 562 266	0.510	167 562 276	0.510
63	50	10	1670	167 562 267	0.940	167 562 277	0.940

d (mm)	D (mm)	L (mm)	L2 (mm)	e (mm)	closest inch (inch)
50	97	191	89	3	1 ½
63	124	220	101	4	2

Valve ends



ecoFIT Valve end 546 and 543 (G40) With fusion socket metric

Model:

- Material: PE100

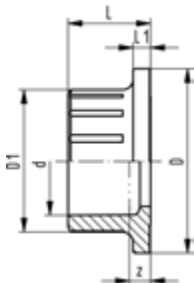

d (mm)	PN (bar)	Code	Weight (kg)	D (mm)	D1 (mm)	L (mm)	L1 (mm)	z (mm)
16	16	193 480 175	0.007	38	23	19	4	5
20	16	193 480 176	0.007	38	27	20	4	5
25	16	193 480 177	0.012	44	33	22	5	6
32	16	193 480 178	0.017	53	41	24	5	6
40	16	193 480 179	0.026	65	51	26	5	7
50	16	193 480 180	0.042	77	62	29	6	8
63	16	193 480 181	0.075	99	77	34	7	8



ecoFIT Valve end 546 and 543 (G41) With butt fusion spigot IR-Plus® SDR11 metric

Model:

- Material: PE100

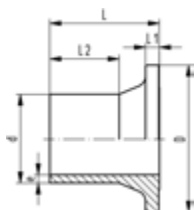

d (mm)	FM	PN (bar)	Code	Weight (kg)	D (mm)	L (mm)	L1 (mm)	L2 (mm)	e (mm)
20	IR	16	193 480 102	0.008	38	37	4	25	1.9
25	IR	16	193 480 103	0.013	44	39	5	25	2.3
32	IR	16	193 480 104	0.019	53	40	5	25	2.9
40	IR	16	193 480 105	0.030	65	43	5	25	3.7
50	IR	16	193 480 106	0.054	77	51	6	25	4.6
63	IR	16	193 480 107	0.096	99	60	7	28	5.8



ecoFIT Valve end 546 and 543 (G42) With butt fusion spigot IR-Plus® SDR17.6 metric

Model:

- Material: PE100

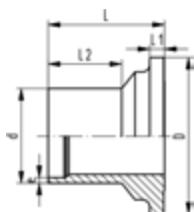

d (mm)	FM	PN (bar)	Code	Weight (kg)	D (mm)	L (mm)	L1 (mm)	L2 (mm)	e (mm)
40	IR	10	193 480 086	0.030	65	43	5	25	2.3
50	IR	10	193 480 087	0.053	77	51	6	25	2.9
63	IR	10	193 480 088	0.096	99	60	7	28	3.6

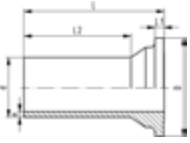

ecoFIT
Valve end 546 and 543 (G43)
With butt fusion spigot long SDR11 metric

Model:

- Material: PE100

d (mm)	PN (bar)	Code	Weight (kg)	D (mm)	L (mm)	L1 (mm)	L2 (mm)	e (mm)
20	16	193 480 152	0.013	38	69	4	53	2.2
25	16	193 480 153	0.023	44	76	5	58	2.3
32	16	193 480 154	0.032	53	76	5	58	2.9
40	16	193 480 155	0.054	65	82	5	61	3.7
50	16	193 480 156	0.086	77	91	6	63	4.6
63	16	193 480 157	0.165	99	110	7	77	5.8
75	16	193 480 158	0.280	125	125	9	89	6.8
90	16	193 480 159	0.447	150	140	10	103	8.2
110	16	193 480 160	0.731	180	160	11	117	10.0

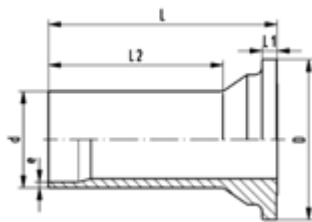

ecoFIT
Valve end 546 and 543 (G44)
With butt fusion spigot long SDR17,6 metric

Model:

- Material: PE100

d (mm)	PN (bar)	Code	Weight (kg)	D (mm)	L (mm)	L1 (mm)	L2 (mm)	e (mm)
75	16	193 480 168	0.260	125	125	9	89	4.3
90	16	193 480 169	0.415	150	140	10	103	5.1
110	16	193 480 170	0.683	180	160	11	117	6.3

Industry product ranges

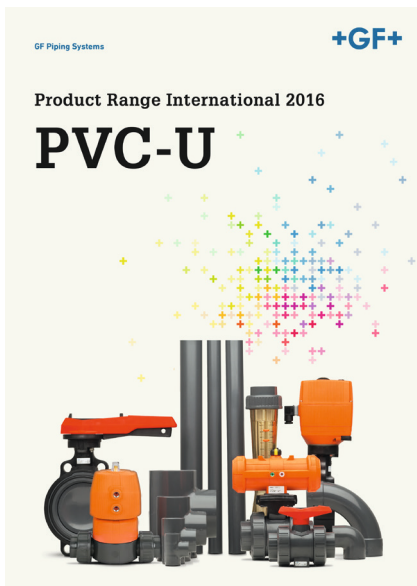

Product Range PVC-U



**Product Range Signet
Measurement and Control**

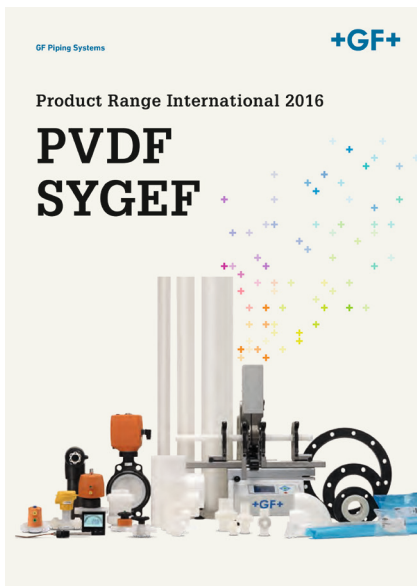

Product Range SYGEF and PVDF



Automation made easy







Further Product Ranges you will find at:
www.gfps.com/download-center

Flanged Connections

The right size for every challenge



Flanged connections

Flanged connections		Page
	Flange adaptors long end	171
	Flange adaptors short end	175
	Flanges for butt fusion systems	182
	Flange adaptors for socket fusion systems	189
	Flanges for socket fusion systems	191
	Gaskets	193



Flange adaptors long end

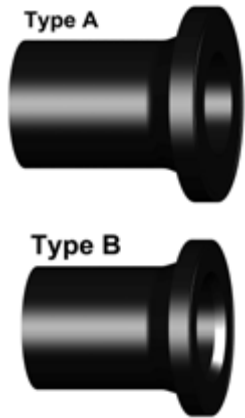

Flange adaptor PE100 SDR11 Combined jointing face: flat and serrated

Model:

- Long spigot
- Material: PE100
- For IR, butt- and electro fusion
- Suitable for flange connections to metric (from d110 also to ANSI/ASME B16.5)
- Gasket d20-d630: Profile flange gasket NBR No. 45 44 07, EPDM No. 48 44 07
- Gasket d710-d1000: flat gasket EPDM No. 48 40 03
- Type A without chamfer, Type B with chamfer
- 10 bar Gas / 16 bar Water
- Up to d315, suitable for butterfly valve type 567/578. Above use ecoFIT adaptor for butterfly valves SDR11 (d355-d1200)

* Not suitable for butterfly valves

** Installation support through moulded ribs

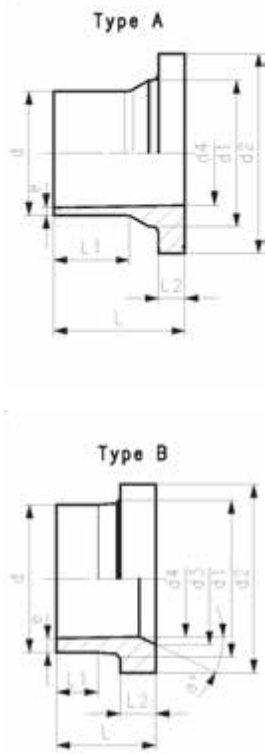

d (mm)	DN (mm)	FM	Code	Weight (kg)
20	15	IR	753 800 006	0.022
25	20	IR	753 800 007	0.037
32	25	IR	753 800 008	0.056
40	32	IR	753 800 009	0.081
50	40	IR	753 800 010	0.119
63	50	IR	753 800 011	0.187
75	65	IR	753 800 012	0.314
90	80	IR	753 800 013	0.471
110	100	IR	753 800 014	0.706
125	100	IR	753 800 015	0.883
140	125	IR	753 800 016	1.348
160	150	IR	753 800 017	1.718
180	150	IR	753 800 018	2.035
200	200	IR	753 800 019	2.899
225	200	IR	753 800 020	3.208
250	250		753 800 021	4.878
280	250		753 800 022	4.925
315	300		753 800 023	7.135
**	355	350	753 800 224	10.400
**	400	400	753 800 225	14.500
**	450	500	753 800 226	23.700
**	500	500	753 800 227	27.100
*	560	600	753 800 028	40.000
*	630	600	753 800 029	42.300
*	710	700	753 800 030	56.379
*	800	800	753 800 033	72.636

d (mm)	DN (mm)	d1 (mm)	d2 (mm)	d3 (mm)	d4 (mm)	L (mm)	L1 (mm)	L2 (mm)	e (mm)	Type
20	15	27	45		16	85.0	41.0	7	1.9	A
25	20	33	58		20	90.5	62.0	9	2.3	A
32	25	40	68		26	91.5	61.0	10	3.0	A
40	32	50	78		32	94.5	61.5	11	3.7	A
50	40	61	88		40	90.0	62.0	12	4.6	A
63	50	75	102		51	98.0	69.0	14	5.8	A
75	65	89	122	66	61	125.0	89.0	16	6.8	B
90	80	105	138	78	73	140.0	103.0	17	8.2	B
110	100	125	158	100	90	160.0	114.0	18	10.0	B
125	100	132	158	114	102	170.0	125.0	25	11.4	B
140	125	155	188	127	114	200.0	147.0	25	12.7	B
160	150	175	212	151	130	200.0	147.0	25	14.6	B
180	150	180	212	158	147	200.0	170.0	30	16.4	B
200	200	232	268	203	163	200.0	128.0	32	18.2	B
225	200	235	268	210	184	200.0	138.0	32	20.5	B

table continued on the next page



	d	DN	d1	d2	d3	d4	L	L1	L2	e	Type
	(mm)	(mm)	(mm)	(mm)	(mm)	(mm)	(mm)	(mm)	(mm)	(mm)	
	250	250	285	320	252	202	220.0	129.0	35	22.7	B
	280	250	291	320	265	229	231.0	144.0	35	25.4	B
	315	300	335	370	300	257	239.0	158.0	35	28.6	B
**	355	350	373	430	342	284	267.0	170.0	40	32.0	B
**	400	400	427	482	387	320	292.0	185.0	46	36.0	B
**	450	500	514	585	400	360	330.0	205.0	60	41.0	B
**	500	500	530	585	442	400	351.0	220.0	60	46.0	B
*	560	600	615	685	490	458	365.0	230.0	60	50.9	B
*	630	600	642	685	545	515	385.0	250.0	60	57.3	B
*	710	700	737	800		581	400.0	280.0	60	64.5	A
*	800	800	840	905		652	400.0	280.0	65	74.0	A

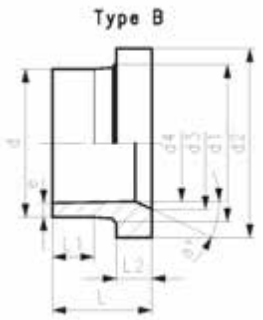

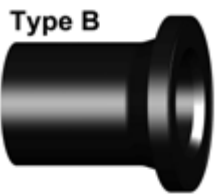
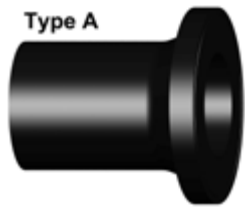

Flange adaptor PE100 SDR17/17.6
Combined jointing face: flat and serrated

Model:

- Long spigot
- Material: PE100
- For IR, butt- and electro fusion
- Suitable for flange connections to metric (from d110 also to ANSI/ASME B16.5)
- Gasket d20-d630: Profile flange gasket NBR No. 45 44 07, EPDM No. 48 44 07
- Gasket d710-d1000: flat gasket EPDM No. 48 40 03
- Type A without chamfer, Type B with chamfer
- 5 bar Gas / 10 bar Water
- Up to d400, suitable for butterfly valve type 567/578. Above use ecoFIT adaptor for butterfly valves SDR17.6 (d450-d1200)

* Not suitable for butterfly valves

** Installation support through moulded ribs

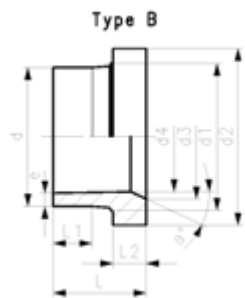
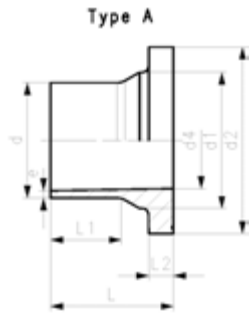

d (mm)	DN (mm)	FM	Code	Weight (kg)
50	40	IR	753 800 085	0.107
63	50	IR	753 800 086	0.168
75	65	IR	753 800 087	0.260
90	80	IR	753 800 088	0.367
110	100	IR	753 800 089	0.571
125	100	IR	753 800 090	0.684
140	125	IR	753 800 091	1.035
160	150	IR	753 800 092	1.342
180	150	IR	753 800 093	1.469
200	200	IR	753 800 094	2.297
225	200	IR	753 800 095	2.456
250	250		753 800 096	3.500
280	250		753 800 097	3.714
315	300		753 800 098	5.470
** 355	350		753 800 299	7.100
** 400	400		753 800 300	9.600
** 450	500		753 800 301	16.400
** 500	500		753 800 302	18.500
* 560	600		753 800 103	27.500
* 630	600		753 800 104	30.000
* 710	700		753 800 105	39.376
* 800	800		753 800 106	50.759
* 900	900		753 800 107	64.202
* 1000	1000		753 800 108	79.495

d (mm)	d1 (mm)	d2 (mm)	d3 (mm)	d4 (mm)	L (mm)	L1 (mm)	L2 (mm)	e (mm)	Type	a°
50	61	88		44	90	62	12	3.0	A	
63	75	102		55	106	70	14	3.8	A	
75	89	122		66	130	75	16	4.5	A	
90	105	138		79	140	103	17	5.4	A	
110	125	158		96	160	117	18	6.6	A	
125	132	158	114	110	170	125	25	7.4	B	30
140	155	188	127	123	200	147	25	8.3	B	30
160	175	212	151	141	200	147	25	9.5	B	30
180	180	212		158	200	170	30	10.7	A	
200	232	268	203	176	200	128	32	11.9	B	30
225	235	268	210	198	200	138	32	13.4	B	30
250	285	320	245	220	220	148	35	14.8	B	25
280	291	320	265	246	230	154	35	16.6	B	30
315	335	370	300	277	242	166	36	18.7	B	30
** 355	373	430	346	310	260	170	33	21.1	B	21
** 400	427	482	395	350	282	185	36	23.7	B	21
** 450	514	585		400	316	205	46	26.7	A	
** 500	530	585		400	337	220	46	29.7	A	
* 560	615	685		493	365	230	60	33.2	A	
* 630	642	685		555	385	250	60	37.4	A	

table continued on the next page

	d	d1	d2	d3	d4	L	L1	L2	e	Type	a°
	(mm)	(mm)	(mm)	(mm)	(mm)	(mm)	(mm)	(mm)	(mm)		
*	710	737	800		626	400	280	50	42.1	A	
*	800	840	905		705	400	280	52	47.4	A	
*	900	944	1005		793	400	260	55	53.3	A	
*	1000	1047	1110		881	400	260	60	59.3	A	

Flange adaptors short end

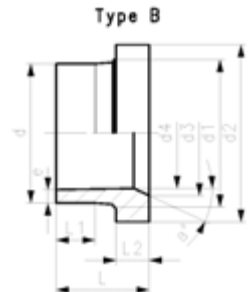
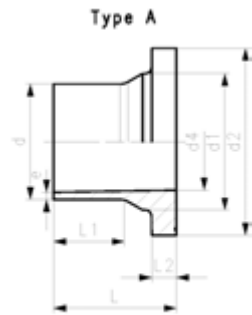

ecoFIT flange adaptor SDR11 Jointing face combination serrated/flat metric

Model:

- Material: PE100
- Conventional butt-welding according to DVS 2207
- IR compatible
- Up to d315, suitable for butterfly valve type 567/578. Above use ecoFIT adaptor for butterfly valves SDR11 (d355-d800)
- Gasket d20-d630: Profile flange gasket NBR No. 45 44 07, EPDM No. 48 44 07
- Gasket d710-d1000: flat gasket EPDM No. 48 40 03
- * Not suitable for butterfly valves

d (mm)	DN (mm)	FM	Code	Weight (kg)
20	15	IR	753 798 306	0.016
25	20	IR	753 798 307	0.034
32	25	IR	753 798 308	0.046
40	32	IR	753 798 309	0.067
50	40	IR	753 798 310	0.098
63	50	IR	753 798 311	0.157
75	65	IR	753 798 312	0.258
90	80	IR	753 798 313	0.347
110	100	IR	753 798 314	0.471
125	100	IR	753 798 315	0.517
140	125	IR	753 798 316	0.780
160	150	IR	753 798 317	0.973
180	150	IR	753 798 318	1.077
200	200	IR	753 798 319	1.734
225	200	IR	753 798 320	1.772
250	250		753 798 321	2.871
280	250		753 798 322	3.760
315	300		753 798 323	4.925
*	355	350	753 798 324	7.000
*	400	400	753 798 325	9.500
*	450	500	753 798 326	18.200
*	500	500	753 798 327	18.700
*	560	600	753 798 833	19.380
*	630	600	753 798 834	16.500
*	710	700	753 798 835	21.586
*	800	800	753 798 836	28.505

d (mm)	DN (mm)	d1 (mm)	d2 (mm)	d3 (mm)	d4 (mm)	L (mm)	L1 (mm)	L2 (mm)	e (mm)	Type	a°
20	15	26	45		16	50	29	7	1.9	A	
25	20	32	58		20	52	27	9	2.3	A	
32	25	40	68		26	54	28	10	2.9	A	
40	32	49	78		32	55	25	11	3.7	A	
50	40	60	88		40	62	32	12	4.6	A	
63	50	75	102		49	68	38	14	5.8	A	
75	65	89	122	66	58	80	43	16	6.8	B	30
90	80	105	138	78	70	80	42	17	8.2	B	30
110	100	125	158	100	87	80	41	18	10.0	B	30
125	100	132	158	114	99	82	35	25	11.4	B	25
140	125	155	188	127	111	89	42	25	12.7	B	27
160	150	175	212	151	127	92	40	25	14.6	B	30
180	150	180	212	154	148	92	40	30	16.4	B	30
200	200	232	268	203	174	100	35	32	18.2	B	30
225	200	235	268	210	196	100	35	32	20.5	B	30
250	250	285	320	252	203	120	45	35	22.7	B	25
280	250	291	320	265	228	120	45	37	25.4	B	30
315	300	335	370	300	256	150	50	50	28.6	B	22

table continued on the next page

	d	DN	d1	d2	d3	d4	L	L1	L2	e	Type	a°
	(mm)	(mm)	(mm)	(mm)	(mm)	(mm)	(mm)	(mm)	(mm)	(mm)		
*	355	350	373	430	342	284	162	70	40	32.2	B	45
*	400	400	427	482	387	320	172	70	46	36.3	B	45
*	450	500	514	585	400	360	225	105	60	40.9	B	15
*	500	500	530	585	442	400	231	105	60	45.4	B	15
*	560	600	615	684	490	458	135	20	60	50.8	B	30
*	630	600	642	684	545	516	135	40	60	57.2	B	30
*	710	700	737	800		581	120	20	60	64.5	A	
*	800	800	840	905		655	120	18	65	72.6	A	

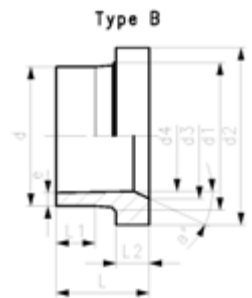
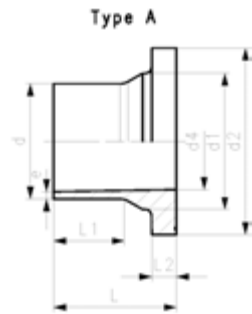

ecoFIT flange adaptor SDR17/17.6
Jointing face combination serrated/flat metric

Model:

- Material: PE100
 - Conventional butt-welding according to DVS 2207
 - IR compatible
 - Up to d400, suitable for butterfly valve type 567/578 and 038/039. Above use ecoFIT adaptor for butterfly valves SDR17.6 (d450-d1200)
 - Gasket d20-d630: Profile flange gasket NBR No. 45 44 07, EPDM No. 48 44 07
 - Gasket d710-d1000: flat gasket EPDM No. 48 40 03
- * Not suitable for butterfly valves

d (mm)	DN (mm)	FM	Code	Weight (kg)
50	40	IR	753 798 210	0.093
63	50	IR	753 798 211	0.118
75	65	IR	753 798 212	0.220
90	80	IR	753 798 213	0.291
110	100	IR	753 798 214	0.389
125	100	IR	753 798 215	0.421
140	125	IR	753 798 216	0.648
160	150	IR	753 798 217	0.703
180	150	IR	753 798 218	0.739
200	200	IR	753 798 219	1.331
225	200	IR	753 798 220	1.304
250	250		753 798 221	2.272
280	250		753 798 222	2.154
315	300		753 798 223	3.819
355	350		753 798 224	4.800
400	400		753 798 225	6.400
* 450	500		753 798 226	12.700
* 500	500		753 798 227	13.000
* 560	600		753 798 858	14.875
* 630	600		753 798 859	12.515
* 710	700		753 798 860	15.878
* 800	800		753 798 861	20.948
* 900	900		753 798 862	29.183
* 1000	1000		753 798 863	36.209

d (mm)	DN (mm)	d1 (mm)	d2 (mm)	d3 (mm)	d4 (mm)	L (mm)	L1 (mm)	L2 (mm)	e (mm)	Type	a°
50	40	60	88	-	44	62	32	12	2.9	A	
63	50	75	102	-	55	68	38	14	3.8	A	
75	65	89	122	-	63	80	43	16	4.5	A	
90	80	105	138	-	76	80	42	17	5.4	A	
110	100	125	158	-	94	80	42	18	6.6	A	
125	100	132	158	114	110	82	35	25	7.4	B	25
140	125	155	188	127	123	89	39	25	8.3	B	27
160	150	175	212	158	138	92	47	18	9.5	B	30
180	150	180	212		158	92	45	20	10.7	A	
200	200	232	268	203	174	100	42	24	11.9	B	30
225	200	235	268	210	196	100	42	24	13.4	B	30
250	250	285	320	252	221	120	45	25	14.8	B	25
280	250	291	320	265	247	120	45	35	16.6	B	30
315	300	335	370	300	278	150	50	50	18.7	B	21
355	350	373	430	346	310	155	70	33	21.1	B	21
400	400	427	482	395	350	162	70	36	23.7	B	21
* 450	500	514	585	400	400	211	105	46	26.7	B	4
* 500	500	530	585	446	442	217	105	46	29.7	A	2
* 560	600	615	685		493	142	60	50	33.2	A	
* 630	600	642	685		555	144	71	50	37.4	A	

table continued on the next page

	d	DN	d1	d2	d3	d4	L	L1	L2	e	Type	a°
	(mm)	(mm)	(mm)	(mm)	(mm)	(mm)	(mm)	(mm)	(mm)	(mm)		
*	710	700	737	800		626	120	20	50	42.1	A	
*	800	800	840	905		705	120	18	52	47.4	A	
*	900	900	944	1005		793	140	15	55	53.3	A	
*	1000	1000	1047	1110		881	140	10	60	59.3	A	



ecoFIT adaptor for butterfly valves SDR11 Joining face flat metric

Model:

- Material: PE100
- Conventional butt-welding according to DVS 2207
- Suitable for butterfly valve type 567/578 and 038/039

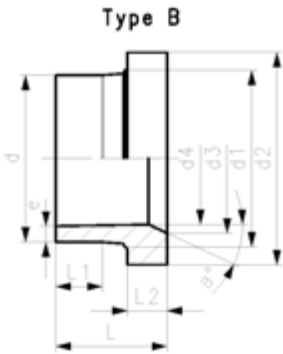

d	DN	Code	Weight	d1	d2	d3	d4	L	L1	L2	e	Type	a°
(mm)	(mm)		(kg)	(mm)	(mm)	(mm)	(mm)	(mm)	(mm)	(mm)	(mm)		
355	350	753 798 924	8.400	373	430	350	284	187	70	65	33.9	B	25
400	400	753 798 925	11.000	427	482	400	320	196	70	70	38.2	B	25
450	450	753 798 926	18.800	467	533	450	360	272	105	107	43.0	B	23
500	500	753 798 927	19.900	530	585	498	400	261	105	90	47.8	B	25
560	600	753 798 728	29.270	615	685	610	458	282	60	147	50.8	B	21
630	600	753 798 729	23.042	642	685	610	515	210	60	132	57.2	B	21
710	700	753 798 730	33.765	737	800	701	581	215	20	155	64.5	B	20
800	800	753 798 731	41.787	840	905	785	655	194	18	140	72.6	B	28



ecoFIT adaptor for butterfly valves SDR17/17.6 Joining face flat metric

Model:

- Material: PE100
- Conventional butt-welding according to DVS 2207
- Suitable for butterfly valve type 567/578 and 038/039

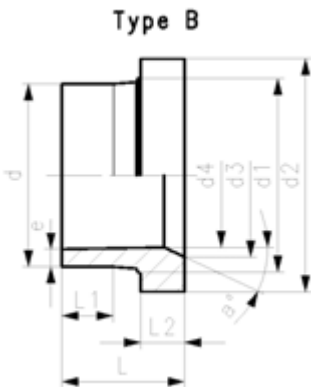

d	DN	Code	Weight	d1	d2	d3	d4	L	L1	L2	e	Type	a°
(mm)	(mm)		(kg)	(mm)	(mm)	(mm)	(mm)	(mm)	(mm)	(mm)	(mm)		
450	500	753 798 951	10.700	467	533	397	397	224	105	59	27.5	B	23
500	500	753 798 952	12.100	530	585	498	440	217	105	46	30.5	B	25
560	600	753 798 753	17.307	615	685	610	493	227	60	92	33.2	B	21
630	600	753 798 754	12.122	642	685	610	555	149	60	71	37.4	B	21
710	700	753 798 755	21.505	737	800	701	625	175	20	105	42.1	B	17
800	800	753 798 756	21.841	840	905	785	705	142	18	74	47.4	B	22
900	900	753 798 757	34.187	944	1005	890	793	189	15	104	53.3	B	18
1000	1000	753 798 758	43.733	1047	1110	994	881	204	10	124	59.3	B	17
1200	1200	753 798 759	106.295	1256	1330	1186	1057	377	160	126	71.2	B	17

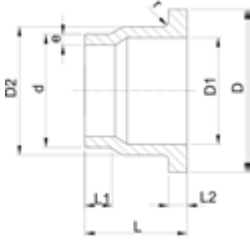

ecoFIT outlet flange adaptor SDR11

Model:

- Material: PE80
- Suitable for wafer check valves Type 369
- Conventional butt-welding according to DVS 2207

Attention:

- In conjunction with outlet flange adaptors, **flange rings for socket systems** must be used.

DN (mm)	d (mm)	Code	Weight (kg)	D (mm)	D1 (mm)	D2 (mm)	L (mm)	L1 (mm)	L2 (mm)	e (mm)	r (mm)
32	40	733 808 034	0.073	80	37	50	64	30	11	3.7	3
40	50	733 808 035	0.104	90	43	61	67	30	12	4.6	3
50	63	733 808 036	0.172	105	54	76	74	30	14	5.8	4
65	75	733 808 037	0.242	125	70	90	78	30	16	6.8	4
80	90	733 808 038	0.348	140	82	108	87	35	17	8.2	4
100	110	733 808 039	0.508	160	105	131	102	41	18	10.0	4
125	140	733 808 041	0.976	190	130	165	124	47	25	12.7	4
150	160	733 808 042	1.337	215	158	188	149	52	25	14.6	4
200	225	733 808 045	2.814	270	206	248	180	55	32	20.5	4
250	280	733 808 047	4.374	325	259	308	240	63	35	25.4	4
300	315	733 808 048	4.960	375	308	346	272	66	35	28.6	4

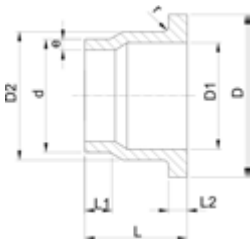

ecoFIT outlet flange adaptor SDR17.6

Model:

- Material: PE80
- Conventional butt-welding according to DVS 2207
- Suitable for wafer check valves Type 369

Attention:

- In conjunction with outlet flange adaptors, **flange rings for socket systems** must be used.

d (mm)	DN (mm)	Code	Weight (kg)	D (mm)	D1 (mm)	D2 (mm)	L (mm)	L1 (mm)	L2 (mm)	e (mm)	r (mm)
40	32	733 808 009	0.060	80	37	50	64	30	11	2.3	3
50	40	733 808 010	0.067	90	43	61	67	30	12	2.9	3
63	50	733 808 011	0.159	105	54	76	74	30	14	3.6	4
75	65	733 808 012	0.219	125	70	90	78	30	16	4.3	4
90	80	733 808 013	0.314	140	82	108	87	35	17	5.1	4
110	100	733 808 014	0.465	160	105	131	102	41	18	6.3	4
140	125	733 808 016	0.862	190	130	165	124	47	18	8.0	4
160	150	733 808 017	1.176	215	158	188	149	52	18	9.1	4
225	200	733 808 020	2.484	270	206	248	180	55	24	12.8	4
280	250	733 808 022	2.230	325	259	308	240	63	25	15.9	4
315	300	733 808 023	2.450	375	308	346	272	66	25	17.9	4

Component Parts for Flange Assembly, Typ 369 PP

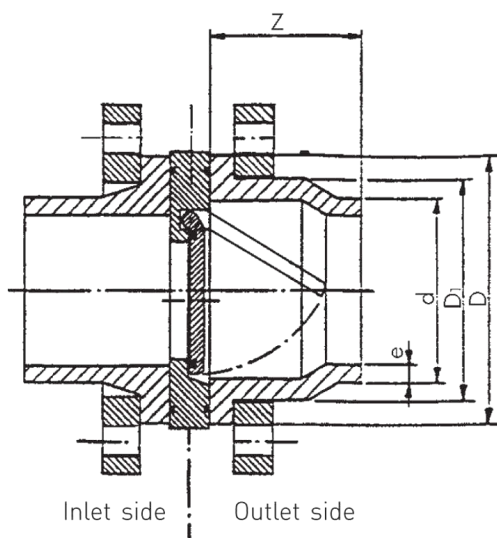

Warning: This outlet flange adaptor has to be installed on the outlet side!

Socket Fusion System PP/PE Inlet side

PP/PE
Flange adaptor
metric

d	DN	Inch	PP Code	PE Code					
40	32	1 1/4	727 790 209	753 790 209					
50	40	1 1/2	727 790 210	753 790 210					
63	50	2	727 790 211	753 790 211					
75	65	2 1/2	727 790 212	753 790 212					
90	80	3	727 790 213	753 790 213					
110	100	4	727 790 214	753 790 214					

Backing flange metric
for socket fusion systems
Connecting dimension
DIN 2501 PN 10

d	DN	Inch	for flange adaptor metric PP-V black	for flange adaptor metric PP with steel ring					
40	32	1 1/4	727 700 409	727 700 209					
50	40	1 1/2	727 700 410	727 700 210					
63	50	2	727 700 411	727 700 211					
75	65	2 1/2	727 700 412	727 700 212					
90	80	3	727 700 413	727 700 213					
110	100	4	727 700 414	727 700 214					

Outlet side

PP/PE
Outlet flange adaptor
with fusion socket
metric

d	DN	Inch	Joining face flat PP Code	Joining face flat PE Code	D	D ₁	Z		
40	32	1 1/4	727 800 009	733 800 009	61	50	35		
50	40	1 1/2	727 800 010	733 800 010	73	61	38		
63	50	2	727 800 011	733 800 011	90	76	41		
75	65	2 1/2	727 800 012	733 800 012	106	90	49		
90	80	3	727 800 013	733 800 013	125	108	65		
110	100	4	727 800 014	733 800 014	150	130	62		

Backing flange metric
for socket fusion systems
Connecting dimension
DIN 2501 PN 10

d	DN	Inch	for outlet flange adaptor PP-V black	for outlet flange adaptor PP with steel ring					
40	32	1 1/4	727 700 409	727 700 209					
50	40	1 1/2	727 700 410	727 700 210					
63	50	2	727 700 411	727 700 211					
75	65	2 1/2	727 700 412	727 700 212					
90	80	3	727 700 413	727 700 213					
110	100	4	727 700 414	727 700 214					

Component Parts for Flange Assembly, Type 369 PP

Butt Fusion System PP/PE

Inlet side

PP/PE Flange Adapter metric SDR 11	d	DN	Inch	PP Code	PE Code				
		40	32	1 $\frac{1}{4}$	727 798 509	753 798 609			
	50	40	1 $\frac{1}{2}$	727 798 510	753 798 610				
	63	50	2	727 798 511	753 798 611				
	75	65	2 $\frac{1}{2}$	727 798 512	753 798 612				
	90	80	3	727 798 513	753 798 613				
	110	100	4	727 798 514	753 798 614				
	140	125	5	727 798 516	753 798 616				
	160	150	6	727 798 517	753 798 617				
	225	200	8	727 798 520	753 798 620				
	280	250	10	727 798 572	753 798 672				
	315	300	12	727 798 573	753 798 673				

PP/PE Flange Adapter metric SDR 17,6	d	DN	Inch	PP Code	PE Code				
		40	32	1 $\frac{1}{4}$	--	--			
	50	40	1 $\frac{1}{2}$	727 798 535	753 798 535				
	63	50	2	727 798 536	753 798 536				
	75	65	2 $\frac{1}{2}$	727 798 412	753 798 512				
	90	80	3	727 798 413	753 798 513				
				727 798 414	753 798 514				
	110	100	4						
	140	125	5	727 798 541	753 798 541				
	160	150	6	727 798 542	753 798 542				
	225	200	8	727 798 545	753 798 545				
	280	250	10	727 798 547	753 798 547				
	315	300	12	727 798 548	753 798 548				

Backing flange metric for butt fusion systems Connecting dimension DIN 2501 PN 10	d	DN	Inch	for Flange Adapter PP-V black	for Flange Adapter PP with steel ring				
		40	32	1 $\frac{1}{4}$	727 700 409	727 700 209			
	50	40	1 $\frac{1}{2}$	727 700 410	727 700 210				
	63	50	2	727 700 411	727 700 211				
	75	65	2 $\frac{1}{2}$	727 700 412	727 700 212				
	90	80	3	727 700 513	727 700 313				
	110	100	4	727 700 514	727 700 314				
	140	125	5	727 700 516	727 700 316				
	160	150	6	727 700 517	727 700 317				
	225	200	8	727 700 520	727 700 320				
	280	250	10	727 700 522	727 700 322				
	315	300	12	727 700 523	727 700 323				

Flanges for butt fusion systems

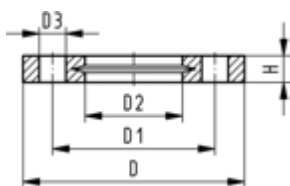

Backing flange PP-V metric For butt fusion systems metric

Model:

- Full-plastic flange PP-GF (30 % glass-fibre reinforced)
- Connecting dimension: ISO 7005, EN 1092, BS 4504, DIN 2501
- **Bolt circle PN 10**

AL: number of holes

¹⁾ Suitable for socket- and butt fusion systems

²⁾ Combined version, metric-ANSI

	d (mm)	DN (mm)	PN (bar)	Code	Weight (kg)	D (mm)	D1 (mm)	D2 (mm)	D3 (mm)	H (mm)	AL	SC	
	1	20	15	16	727 700 406	0.093	95	65	28	14	16	4	M12
	1	25	20	16	727 700 407	0.120	105	75	34	14	17	4	M12
	1	32	25	16	727 700 408	0.151	115	85	42	14	18	4	M12
	1	40	32	16	727 700 409	0.244	140	100	51	18	20	4	M16
	1	50	40	16	727 700 410	0.297	150	110	62	18	22	4	M16
	1	63	50	16	727 700 411	0.362	165	125	78	18	24	4	M16
	1	75	65	16	727 700 412	0.487	185	145	92	18	26	4	M16
		90	80	16	727 700 513	0.544	200	160	108	18	27	8	M16
		110	100	16	727 700 514	0.643	220	180	128	18	28	8	M16
		125	100	16	727 700 515	0.635	220	180	135	18	28	8	M16
		140	125	16	727 700 516	0.842	250	210	158	18	30	8	M16
	2	160	150	16	727 700 517	1.200	285	240	178	22	32	8	M20
		180	150	16	727 700 518	1.200	285	240	188	22	32	8	M20
	2	200	200	16	727 700 519	1.400	340	295	235	22	34	8	M20
	2	225	200	16	727 700 520	1.400	340	295	238	22	34	8	M20
		250	250	10	727 700 521	2.052	395	350	288	22	38	12	M20
		280	250	10	727 700 522	1.700	395	350	294	22	38	12	M20
		315	300	10	727 700 523	2.400	445	400	338	22	42	12	M20
		355	350	10	727 700 524	4.440	515	460	376	22	46	16	M20
		400	400	10	727 700 525	5.624	574	515	430	26	50	16	M24



Backing flange PP-V Inch ANSI For butt fusion systems metric

Model:

- Full-plastic flange PP-GF (30 % glass-fibre reinforced)
- Connecting dimension: ANSI/ASME B 16.5 class 150, ASTM D 4024, BS 1560, BS EN 1759
- **Bolt circle class 150**
- Special flange adapter ANSI for d25 - d50 and d90 required

AL: number of holes

¹⁾ Suitable for socket- and butt fusion systems

²⁾ Combined version, metric-ANSI

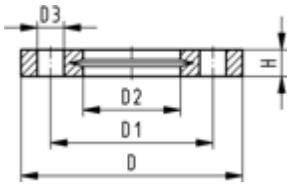

	Size	d	DN	PN	Code	Weight	D	D1	D2	D3	H	AL	SC
	(inch)	(mm)	(mm)	(bar)		(kg)	(mm)	(mm)	(mm)	(mm)	(mm)		
1	½	20	15	16	727 701 406	0.091	95	60	28	16	16	4	M12
1	¾	25	20	16	727 701 407	0.120	105	70	34	16	17	4	M12
1	1	32	25	16	727 701 408	0.147	115	79	42	16	18	4	M12
1	1 ¼	40	32	16	727 701 409	0.246	140	89	51	16	20	4	M16
1	1 ½	50	40	16	727 701 410	0.299	150	98	62	16	22	4	M16
1	2	63	50	16	727 701 411	0.361	165	121	78	19	24	4	M16
1	2 ½	75	65	16	727 701 412	0.492	185	140	92	19	26	4	M16
	3	90	80	16	727 701 513	0.607	200	152	108	19	27	4	M16
	4	110	100	16	727 701 514	0.736	229	190	128	19	28	8	M16
2	6	160	150	16	727 700 517	1.200	285	240	178	22	32	8	M20
2	8	200	200	16	727 700 519	1.400	340	295	235	22	34	8	M20
2	8	225	200	16	727 700 520	1.400	340	295	238	22	34	8	M20
	10	250	250	10	727 701 521	2.241	406	362	288	26	38	12	M20
	10	280	250	10	727 701 522	2.173	406	362	294	26	38	12	M20
	12	315	300	10	727 701 523	3.627	483	432	338	26	42	12	M20

Backing flange PP-Steel metric For butt fusion systems metric

Model:

- Material: PP (30% glass-fibre reinforced) with steel ring
- Connecting dimension: ISO 7005, EN 1092, BS 4504, DIN 2501
- **Bolt circle PN 10**

AL: number of holes

¹⁾ Suitable for socket -and butt fusion systems

²⁾ Combined version, bolt circle metric - ANSI

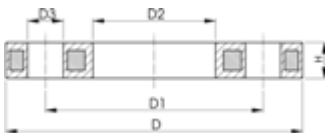

	d	DN	PN	Code	Weight	D	D1	D2	D3	H	AL	SC
	(mm)	(mm)	(bar)		(kg)	(mm)	(mm)	(mm)	(mm)	(mm)		
1	20	15	16	727 700 206	0.216	95	65	28	14	12	4	M12
1	25	20	16	727 700 207	0.279	105	75	34	14	12	4	M12
1	32	25	16	727 700 208	0.429	115	85	42	14	16	4	M12
1	40	32	16	727 700 209	0.621	140	100	51	18	16	4	M16
1	50	40	16	727 700 210	0.722	150	110	62	18	20	4	M16
1	63	50	16	727 700 211	0.900	165	125	78	18	20	4	M16
1	75	65	16	727 700 212	1.110	185	145	92	18	20	4	M16
	90	80	16	727 700 313	1.390	200	160	108	18	20	8	M16
	110	100	16	727 700 314	1.407	220	180	128	18	20	8	M16
	125	100	16	727 700 315	1.408	220	180	135	18	20	8	M16
	140	125	16	727 700 716	2.318	250	210	158	18	26	8	M16
2	160	150	16	727 700 717	3.491	285	241	178	22	26	8	M20
	180	150	16	727 700 718	3.108	285	241	188	22	26	8	M20
2	200	200	16	727 700 719	5.600	340	297	235	22	29	8	M20
2	225	200	16	727 700 720	5.533	340	297	238	22	29	8	M20
	250	250	16	727 700 721	6.632	395	350	288	22	32	12	M20
	280	250	16	727 700 722	6.573	395	350	294	22	32	12	M20
	315	300	16	727 700 723	7.903	445	400	338	22	36	12	M20
	355	350	16	727 700 724	14.587	515	460	376	23	42	16	M20
	400	400	16	727 700 725	20.034	574	515	430	26	42	16	M24



**Profiled backing flange PP-Steel metric
For butt fusion systems metric**

Model:

- PP with glass-fibre reinforcement and GGG 50 insert
- Connecting dimensions: ISO 7005, EN 1092, DIN 2501
- **Bolt circle PN 10**

Note:

flat side = bolt side profiled side = flange adaptor side

AL: number of holes

* Galvanized steel S235-JR, suitable for underground laying

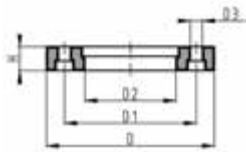

	d (mm)	DN (mm)	PN (bar)	Code	Weight (kg)	D (mm)	D1 (mm)	D2 (mm)	D3 (mm)	H (mm)	AL	SC
*	450	450	10	724 705 026	38.000	615	565	470	26	36	20	M24
	450	500	10	724 700 426	25.600	685	620	517	26	56	20	M24
	500	500	10	724 700 427	21.061	685	620	533	26	56	20	M24
	560	600	10	724 700 428	35.000	796	725	618	30	68	20	M27
	630	600	10	724 700 429	28.500	800	725	645	30	68	20	M27
	710	700	6	724 700 430	25.500	912	840	740	30	49	24	M27
	800	800	6	724 700 431	39.300	1026	950	843	33	58	24	M30
	900	900	6	724 700 432	48.500	1129	1050	947	33	62	28	M30



**Profiled backing flange PP-Steel metric
For butt fusion systems metric**

Model:

- PP with glass-fibre reinforcement and GGG 50 insert
- Connecting dimensions: ISO 7005, EN 1092, DIN 2501
- **Bolt circle PN 16**

Note:

flat side = bolt side profiled side = flange adaptor side

AL: number of holes

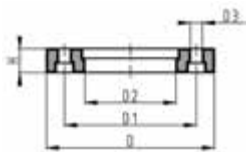

	d (mm)	DN (mm)	PN (bar)	Code	Weight (kg)	D (mm)	D1 (mm)	D2 (mm)	D3 (mm)	H (mm)	AL	SC
	200	200	16	724 700 319	3.549	344	295	235	22	31	12	M20
	225	200	16	724 700 320	3.380	344	295	238	22	31	12	M20
	250	250	16	724 700 321	6.390	410	355	288	26	35	12	M24
	280	250	16	724 700 322	6.310	410	355	294	26	36	12	M24
	315	300	16	724 700 323	9.740	455	410	338	26	43	12	M24
	355	350	16	724 700 324	15.203	521	470	376	26	55	16	M24
	400	400	16	724 700 325	20.600	582	525	430	30	56	16	M27



Backing flange PP-Steel Inch/ANSI For butt fusion systems metric

Model:

- Material: PP (30% glass-fibre reinforced) with steel ring
- Connecting dimension: ANSI/ASME B 16.5 class 150, ASTM D 4024, BS 1560, BS EN 1759
- **Bolt circle class 150**
- Special flange adapter ANSI for d25 - d50 and d90 required

¹⁾ Suitable for socket -and butt fusion systems

²⁾ Combined version, bolt circle metric - ANSI

AL: number of holes

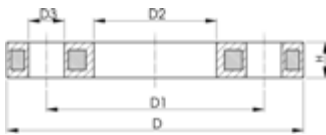

	d (inch)	d (mm)	DN (mm)	PN (bar)	Code	Weight (kg)	D (mm)	D1 (mm)	D2 (mm)	D3 (mm)	H (mm)	AL	SC
1	½	20	15	16	727 701 206	0.213	95	60	28	16	12	4	M12
1	¾	25	20	16	727 701 207	0.260	105	70	34	16	12	4	M12
1	1	32	25	16	727 701 208	0.416	115	79	42	16	16	4	M12
1	1 ¼	40	32	16	727 701 209	0.730	140	89	51	16	16	4	M16
1	1 ½	50	40	16	727 701 210	0.809	150	98	62	16	18	4	M16
1	2	63	50	16	727 701 211	0.866	165	121	78	19	18	4	M16
1	2 ½	75	65	16	727 701 212	1.117	185	140	92	19	18	4	M16
	3	90	80	16	727 701 313	1.499	200	152	108	19	20	4	M16
	4	110	100	16	727 701 314	1.739	229	190	128	19	20	8	M16
2	6	160	150	16	727 700 717	3.491	285	241	178	22	26	8	M20
2	8	200	200	16	727 700 719	5.600	340	297	235	22	29	8	M20
2	8	225	200	16	727 700 720	5.533	340	297	238	22	29	8	M20
	10	250/280	250	10	727 701 321	6.000	406	362	293	25	30	12	M24
	12	315	300	10	727 701 322	11.800	483	432	338	25	34	12	M24
	14	355	350	10	727 701 323	17.900	540	476	376	29	42	12	M27
	16	400	400	10	727 701 324	24.500	597	539	429	29	44	16	M27
	20	450/500	500	10	727 701 325	33.600	712	635	540	32	53	20	M30



Backing flange steel metric For butt fusion systems metric

Model:

- Material: S235JR / zinc-coated
- Connecting dimensions: ISO 7005, EN 1092, DIN 2501
- **Bolt circle PN 10**

AL: number of holes

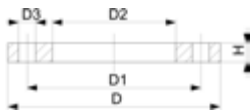

	d (mm)	DN (mm)	PN (bar)	Code	Weight (kg)	D (mm)	D1 (mm)	D2 (mm)	D3 (mm)	H (mm)	AL	SC
	200	200	10	701 474 383	7.400	340	295	235	22	20	8	M20
	225	200	10	701 474 388	7.400	340	295	238	22	20	8	M20
	250	250	10	701 474 399	9.090	395	350	288	22	22	12	M20
	280	250	10	701 474 400	8.700	395	350	294	22	22	12	M20
	315	300	10	701 474 401	12.200	445	400	338	22	26	12	M20
	355	350	10	701 480 489	18.300	505	460	376	22	28	16	M20
	450	450	10	724 705 026	38.000	615	565	470	26	36	20	M24
	400	400	10	701 480 490	22.900	565	515	430	26	32	16	M24
	450	500	10	701 480 491	37.000	670	620	517	26	38	20	M24
	500	500	10	701 480 492	32.000	670	620	533	26	38	20	M24
	560	600	10	701 480 493	53.800	780	725	618	30	42	20	M27
	630	600	10	701 480 494	45.100	780	725	645	30	42	20	M27

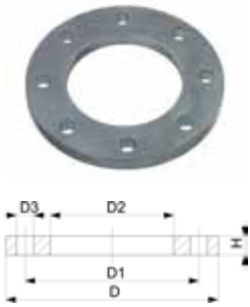

Backing flange steel metric For butt fusion systems metric

Model:

- Material: S235JR / zinc-coated
- Connecting dimensions: ISO 7005, EN 1092, DIN 2501
- **Bolt circle PN 16**

AL: number of holes

d	DN	PN	Code	Weight	D	D1	D2	D3	H	AL	SC
(mm)	(mm)	(bar)		(kg)	(mm)	(mm)	(mm)	(mm)	(mm)		
32	25	16	701 474 390	1.100	115	85	42	14	12	4	M12
40	32	16	701 474 391	1.500	140	100	51	18	14	4	M16
50	40	16	701 474 392	1.600	150	110	62	18	14	4	M16
63	50	16	701 474 393	1.900	165	125	78	18	16	4	M16
75	65	16	701 474 394	2.400	185	145	92	18	16	4	M16
90	80	16	701 474 395	2.900	200	160	108	18	18	8	M16
110	100	16	701 474 396	3.100	220	180	128	18	18	8	M16
125	100	16	701 474 397	3.060	220	180	135	18	18	8	M16
125	125	16	701 474 386	6.000	250	210	135	18	25	8	M16
140	125	16	701 474 387	3.700	250	210	158	18	18	8	M16
160	150	16	701 474 382	5.100	285	240	178	22	20	8	M20
180	150	16	701 474 398	4.800	285	240	188	22	20	8	M20
200	200	16	701 480 475	7.400	340	295	235	22	24	12	M20
225	200	16	701 480 476	7.400	340	295	238	22	24	12	M20
250	250	16	701 480 477	13.000	405	355	288	26	30	12	M24
280	250	16	701 480 478	12.600	405	355	294	26	30	12	M24
315	300	16	701 480 479	18.400	460	410	338	26	34	12	M24
355	350	16	701 480 480	25.000	520	470	376	26	35	16	M24
400	400	16	701 480 481	31.000	580	525	430	30	38	16	M27
450	500	16	701 480 482	37.000	715	650	517	33	46	20	M30
500	500	16	701 480 483	32.000	715	650	533	33	46	20	M30



Profiled backing flange steel metric For butt fusion systems metric

Model:

- Ductile iron (GGG40), epoxy coated (black)
- Connecting dimensions: ISO 7005, EN 1092, DIN 2501
- **Bolt circle PN 10**

* Galvanized steel S235-JR, suitable for underground laying
AL: number of holes

Note:

flat side = bolt side profiled side = flange adaptor side

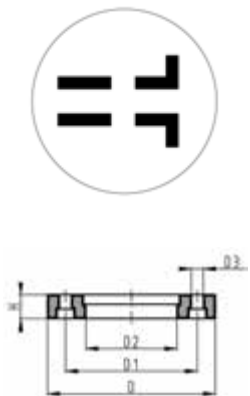

d	DN	PN	Code	Weight	D	D1	D2	D3	H	AL	SC	
(mm)	(mm)	(bar)		(kg)	(mm)	(mm)	(mm)	(mm)	(mm)			
*	450	450	10	724 705 026	38.000	615	565	470	26	44	20	M24
	710	700	6	724 705 130	36.400	900	840	740	30	45	24	M27
	800	800	6	724 705 131	50.500	1015	950	843	33	53	24	M30
	900	900	6	724 705 132	55.800	1115	1050	947	33	56	28	M30
	1000	1000	6	724 705 133	71.100	1230	1160	1050	36	62	28	M33
	1200	1200	4	724 705 134	101.000	1455	1380	1260	39	68	32	M36



Blanking flange set PE Combined jointing face flat and serrated metric

Model:

- d63 - d315: backing flange PP-V with end blank PE
- d355 - d630: backing flange PP/Steel with end blank PE
- Connecting dimensions: ISO 7005, EN 1092, DIN 2501
- **Bolt circle PN 10**

AL: number of holes

L: length of the End Blank

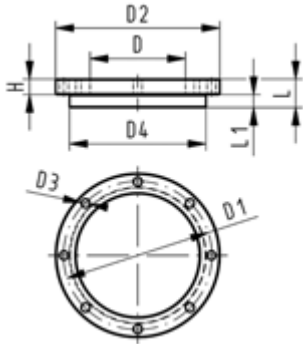

d	DN	PN	Code	Weight	D	D1	D2	D3	D4	L	L1	H	AL	SC
(mm)	(mm)	(bar)		(kg)	(mm)	(mm)	(mm)	(mm)	(mm)	(mm)	(mm)	(mm)		
63	50	16	753 700 611	0.560	75	125	165	18	102	30	14	24	4	M16
75	65	16	753 700 612	0.910	89	145	185	18	122	30	16	26	4	M16
90	80	16	753 700 613	0.921	105	160	200	18	138	30	17	27	8	M16
110	100	16	753 700 614	1.158	125	180	220	18	158	30	18	28	8	M16
125	100	16	753 700 615	1.678	132	180	220	18	158	35	25	28	8	M16
140	125	16	753 700 616	1.913	155	210	250	18	188	40	25	30	8	M16
160	150	16	753 700 617	2.373	175	240	285	22	212	40	25	32	8	M20
180	150	16	753 700 618	2.430	180	240	285	22	212	45	30	32	8	M20
200	200	16	753 700 619	3.495	232	295	340	22	268	50	32	34	8	M20
225	200	16	753 700 620	3.744	235	295	340	22	268	50	32	34	8	M20
250	250	16	753 700 621	6.051	285	350	395	22	320	55	35	38	12	M20
280	250	16	753 700 622	6.305	291	350	395	22	320	60	35	38	12	M20
315	300	16	753 700 623	8.894	335	400	445	22	370	65	35	42	12	M20
355	350	16	753 700 624	23.198	373	460	515	22	430	70	40	40	16	M20
400	400	16	753 700 625	30.766	427	515	574	26	482	75	46	40	16	M24
450	500	10	753 700 626	44.271	510	620	684	26	585	80	60	49	20	M24
500	500	10	753 700 627	47.165	530	620	684	26	585	90	60	49	20	M24
560	600	10	753 700 628	67.147	615	725	796	30	685	100	60	58	20	M27
630	600	10	753 700 629	68.574	642	725	796	30	685	110	60	68	20	M27

Blanking Flanges PE100

Model:

- Made out of sheet material
- **Bolt circle PN 10**

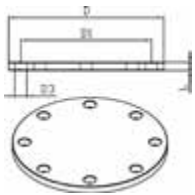

d	PN	DN	Code	Weight	AL	D	L	D1	D3
(mm)	(psi)	(mm)		(kg)		(mm)	(mm)	(mm)	(mm)
63	2,5	50	700 647 886	0.362	4	165	15	125	18
75	2,5	65	700 647 887	0.487	4	185	15	145	18
90	2,5	80	700 647 888	0.544	8	200	15	160	18
110	2,5	100	700 647 889	0.643	8	220	15	180	18
125	2,5	100	700 647 890	0.658	8	220	15	180	18
140	2,5	125	700 647 891	0.842	8	250	15	210	18
160	2,5	150	700 647 892	1.200	8	285	20	240	22
180	2,5	150	700 647 893	1.350	8	285	25	240	22
200	2,5	200	700 647 894	1.400	8	340	25	295	22
225	2,5	200	700 647 895	1.450	8	340	30	295	22
250	2,5	250	700 647 896	2.052	12	395	30	350	22
280	2,5	250	700 647 897	2.380	12	395	30	350	22
315	2,5	300	700 647 898	2.400	12	445	40	400	22
355	2,5	350	700 647 899	4.400	16	515	40	460	22
400	2,5	400	700 647 900	5.620	16	574	45	515	26
450	2,5	500	700 647 901	6.120	20	670	55	620	26
500	2,5	500	700 647 902	7.100	20	670	60	620	26
560	2,5	600	700 647 903	7.650	20	780	65	725	30
630	2,5	600	700 647 904	8.200	20	780	75	725	30

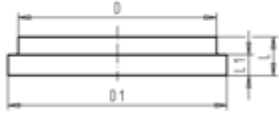

End blank PE
For butt fusion systems metric

Model:

- Suitable for metric backing flanges

d	DN	PN	Code	Weight	D	D1	L	L1
(mm)	(mm)	(bar)		(kg)	(mm)	(mm)	(mm)	(mm)
63	50	16	753 960 611	0.154	75	102	30	14
75	65	16	753 960 612	0.268	89	122	30	16
90	80	16	753 960 613	0.363	105	138	30	17
110	100	16	753 960 614	0.490	125	158	30	18
125	100	16	753 960 615	0.478	132	158	35	25
140	125	16	753 960 616	0.713	155	188	40	25
160	150	16	753 960 617	1.196	175	212	40	25
180	150	16	753 960 618	1.030	180	212	45	30
200	200	16	753 960 619	1.795	232	268	50	32
225	200	16	753 960 620	2.044	235	268	50	32
250	250	16	753 960 621	3.158	285	320	55	35
280	250	16	753 960 622	4.157	291	320	60	35
315	300	16	753 960 623	5.249	335	370	65	35
355	350	16	753 960 624	7.698	373	430	70	40
400	400	16	753 960 625	12.185	427	482	75	46
450	500	16	753 960 626	19.619	510	585	80	60
500	500	16	753 960 627	22.130	530	585	90	60
560	600	16	753 960 628	31.447	615	685	100	60
630	600	16	753 960 629	36.074	642	685	110	60

Flange adaptors for socket fusion systems



ecoFIT flange adaptor Jointing face flat/serrated

Model:

- Material: PE100
- Counterpart: flange adaptor flat/serrated or with O-ring groove
- Connection: according to EN ISO 15494-, DIN 16963-11
- Gasket: profile flange gasket EPDM No. 48 44 07, FKM No. 49 44 07
- Flanges: PP - steel, No. 27 70 02, PP-V, No 27 70 04

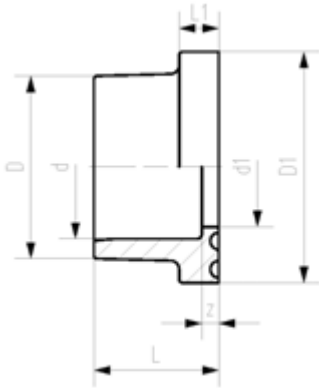

d (mm)	DN (mm)	PN (bar)	Code	Weight (kg)	D (mm)	D1 (mm)	d1 (mm)	L (mm)	L1 (mm)	z (mm)
20	15	10	753 790 206	0.013	27	45	16	19	7	5
25	20	10	753 790 207	0.022	33	58	21	21	9	5
32	25	10	753 790 208	0.035	41	68	28	23	10	5
40	32	10	753 790 209	0.052	50	78	36	25	11	5
50	40	10	753 790 210	0.061	61	88	45	28	12	5
63	50	10	753 790 211	0.095	76	102	57	32	14	5
75	65	10	753 790 212	0.163	90	122	69	36	16	5
90	80	10	753 790 213	0.203	108	138	84	42	17	7
110	100	10	753 790 214	0.293	131	158	100	48	18	7



ecoFIT flange adaptor Jointing face with o-ring groove

Model:

- Material: PE80
- Counterpart: flange adaptor flat/serrated 53 79 02
- Gasket: O-ring EPDM
- Flanges: PP - steel, No. 27 70 02, PP-V, No 27 70 04



d (mm)	DN (mm)	PN (bar)	Code	Weight (kg)	D (mm)	D1 (mm)	d1 (mm)	L (mm)	L1 (mm)	z (mm)
20	15	10	733 810 106	0.008	27	34	16	22	9	8
25	20	10	733 810 107	0.012	33	41	21	24	10	8
32	25	10	733 810 108	0.019	41	50	28	26	10	8
40	32	10	733 810 109	0.031	50	61	36	30	13	10
50	40	10	733 810 110	0.044	61	73	45	33	13	10
63	50	10	733 810 111	0.072	76	90	57	37	14	10
75	65	10	733 810 112	0.112	90	106	69	40	15	10
90	80	10	733 810 113	0.185	108	125	84	47	16	12
110	100	10	733 810 114	0.285	131	150	100	55	18	13



ecoFIT outlet flange adaptor
Jointing face flat

Model:

- Material: PE80
- With fusion socket metric
- Suitable for wafer check valves Type 369
- To be installed on the outlet side of the valve
- Use flanges PP-V 27 70 04

d	DN	PN	Code	Weight	D	D1	L	L1	z
(mm)	(mm)	(bar)		(kg)	(mm)	(mm)	(mm)	(mm)	(mm)
40	32	6	733 800 009	0.065	50	78	55	11	35
50	40	6	733 800 010	0.088	61	88	61	12	38
63	50	6	733 800 011	0.136	76	102	69	14	41
75	65	6	733 800 012	0.223	90	122	79	16	49
90	80	6	733 800 013	0.357	107	138	100	17	65
110	100	6	733 800 014	0.482	130	158	105	18	62

Flanges for socket fusion systems

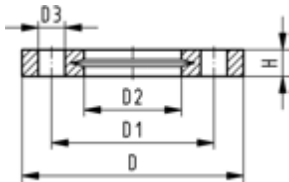

Backing flange PP-V metric For socket systems metric and BS

Model:

- Connecting dimension: ISO 7005, EN 1092, BS 4504, DIN 2501
- **Bolt circle PN 10**
- Full-plastic flange PP-GF (30 % glass-fibre reinforced)

¹⁾ Suitable for socket- and butt fusion systems

²⁾ Not for BS

³⁾ Combined version, metric - ANSI

AL: number of holes

	d (mm)	DN (mm)	PN (bar)	Code	Weight (kg)	D (mm)	D1 (mm)	D2 (mm)	D3 (mm)	H (mm)	AL	SC
1	20	15	16	727 700 406	0.093	95	65	28	14	16	4	M12
1	25	20	16	727 700 407	0.120	105	75	34	14	17	4	M12
1	32	25	16	727 700 408	0.151	115	85	42	14	18	4	M12
1	40	32	16	727 700 409	0.244	140	100	51	18	20	4	M16
1	50	40	16	727 700 410	0.297	150	110	62	18	22	4	M16
1	63	50	16	727 700 411	0.362	165	125	78	18	24	4	M16
1	75	65	16	727 700 412	0.487	185	145	92	18	26	4	M16
	90	80	16	727 700 413	0.550	200	160	110	18	27	8	M16
2	110	100	16	727 700 414	0.640	220	180	133	18	28	8	M16

Backing flange PP-Steel metric For socket systems metric and BS

Model:

- **Bolt circle PN 10**
- PP-GF (30% glass-fibre reinforced) with steel ring
- UV-resistant. Applicable for outside applications
- Connecting dimension: ISO 7005, EN 1092, BS 4504, DIN 2501

AL: number of holes

¹⁾ Suitable for socket -and butt fusion systems

²⁾ Not for BS

³⁾ Connecting dimension: ISO 2536. bolt circle acc. DN125. suitable for flange adaptor d125/ DN100

⁴⁾ Connecting dimension: ISO 2536. bolt circle acc. DN225. suitable for flange adaptor d250/ DN250

⁵⁾ Combined version, bolt circle metric - ANSI

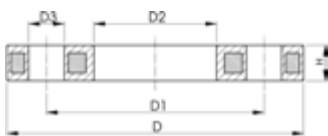

	d (mm)	DN (mm)	PN (bar)	Code	Weight (kg)	D1 (mm)	D3 (mm)	D2 (mm)	D (mm)	H (mm)	AL
1	20	15	16	727 700 206	0.216	65	14	28	95	12	4
1	25	20	16	727 700 207	0.279	75	14	34	105	12	4
1	32	25	16	727 700 208	0.429	85	14	42	115	16	4
1	40	32	16	727 700 209	0.621	100	18	51	140	16	4
1	50	40	16	727 700 210	0.722	110	18	62	150	20	4
1	63	50	16	727 700 211	0.900	125	18	78	165	20	4
1	75	65	16	727 700 212	1.110	145	18	92	185	20	4
	90	80	16	727 700 213	1.369	160	18	110	200	20	8
2	110	100	16	727 700 214	1.522	180	18	133	220	20	8

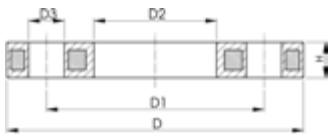

Backing Flange PP-Steel Inch/ANSI For socket systems metric and BS

Model:

- Material: PP (30% glass-fibre reinforced) with steel ring
- Connecting dimension: ANSI/ASME B 16.5 class 150, ASTM D 4024, BS 1560, BS EN 1759
- **Bolt circle class 150**
- Special flange adapter ANSI for d25 - d50 and d90 required

¹⁾ Suitable for socket -and butt fusion systems

²⁾ Not for BS

³⁾ Combined version, bolt circle metric - ANSI

AL: number of holes

	d (inch)	d (mm)	DN (mm)	PN (bar)	Code	Weight (kg)	D (mm)	D1 (mm)	D2 (mm)	D3 (mm)	H (mm)	AL	SC
1	½	20	15	16	727 701 206	0.213	95	60	28	16	12	4	M12
1	¾	25	20	16	727 701 207	0.260	105	70	34	16	12	4	M12
1	1	32	25	16	727 701 208	0.416	115	79	42	16	16	4	M12
1	1 ¼	40	32	16	727 701 209	0.730	140	89	51	16	16	4	M16
1	1 ½	50	40	16	727 701 210	0.809	150	98	62	16	18	4	M16
1	2	63	50	16	727 701 211	0.866	165	121	78	19	18	4	M16
1	2 ½	75	65	16	727 701 212	1.117	185	140	92	19	18	4	M16
	3	90	80	16	727 701 213	1.492	200	152	110	19	20	4	M16
2	4	110	100	16	727 701 214	1.695	229	190	133	19	20	8	M16
3	8	200	200	16	727 700 819	6.143	340	297	226	22	29	8	M20
3	8	225	200	16	727 700 820	4.448	340	297	250	22	29	8	M20

Backing flange PP-V Inch ANSI For socket systems metric and BS

Model:

- Full-plastic flange PP-GF (30 % glass-fibre reinforced)
- Connecting dimension: ANSI/ASME B 16.5 class 150, ASTM D 4024, BS 1560, BS EN 1759
- **Bolt circle class 150**
- Special flange adapter ANSI for d25 - d50 and d90 required

AL: number of holes

¹⁾ Suitable for socket- and butt fusion systems

²⁾ Not for BS

³⁾ Combined version, metric - ANSI

	Size (inch)	DN (mm)	d (mm)	PN (bar)	Code	Weight (kg)	D (mm)	D1 (mm)	D2 (mm)	D3 (mm)	H (mm)	AL	SC
1	½	15	20	16	727 701 406	0.091	95	60	28	16	16	4	M12
1	¾	20	25	16	727 701 407	0.120	105	70	34	16	17	4	M12
1	1	25	32	16	727 701 408	0.147	115	79	42	16	18	4	M12
1	1 ¼	32	40	16	727 701 409	0.246	140	89	51	16	20	4	M16
1	1 ½	40	50	16	727 701 410	0.299	150	98	62	16	22	4	M16
1	2	50	63	16	727 701 411	0.361	165	121	78	19	24	4	M16
1	2 ½	65	75	16	727 701 412	0.492	185	140	92	19	26	4	M16
	3	80	90	16	727 701 413	0.605	200	152	110	19	27	4	M16
2	4	100	110	16	727 701 414	0.704	229	190	133	19	28	8	M16
2/3	6	150	160	16	727 700 417	1.050	285	240	190	22	32	8	M20
3	8	200	200	16	727 700 419	1.629	340	295	226	22	34	8	M20
3	8	200	225	16	727 700 420	1.400	340	295	250	22	34	8	M20
	10	250	280	10	727 701 422	1.838	406	362	310	26	38	12	M20
	12	300	315	10	727 701 423	3.482	483	432	348	26	42	12	M20

Gaskets for socket fusion



Flat gasket EPDM

Model:

- For all metric GF Flange Adaptors
 - Hardness approx. 65° Shore
 - Integrated fixation aids from d110
 - Centering on the inner diameter of the screw crown
- di FA are the suitable inner diameters of flanges adaptors

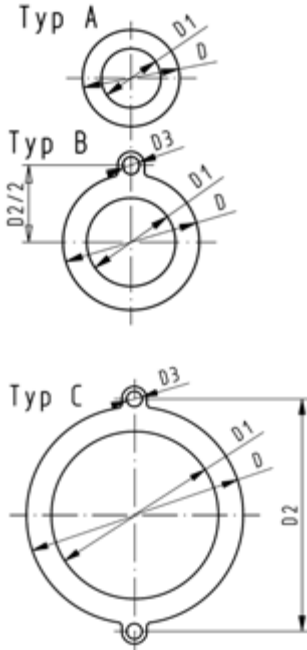

d (mm)	DN (mm)	PN (bar)	Type	EPDM Code	Weight (kg)	D (mm)	D1 (mm)	D2 (mm)	D3 (mm)	H (mm)	di FA (mm)
16	10	10	A	748 400 305	0.004	46	16			2	6 - 26
20	15	10	A	748 400 306	0.012	51	20			2	10 - 30
25	20	10	A	748 400 307	0.004	61	25			2	15 - 35
32	25	10	A	748 400 308	0.008	71	32			2	22 - 42
40	32	10	A	748 400 309	0.013	82	40			3	30 - 50
50	40	10	A	748 400 310	0.016	92	50			3	40 - 60
63	50	10	A	748 400 311	0.018	107	63			3	53 - 73
75	65	10	A	748 400 312	0.029	127	71			3	61 - 81
90	80	10	A	748 400 313	0.035	142	84			3	74 - 94
110	100	10	B	748 400 314	0.051	162	104	180	18	4	94 - 114

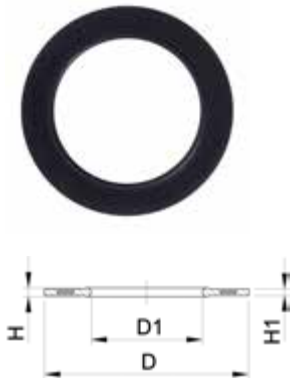

Profile Flange Gasket, metric EPDM / FKM

Model:

- For all metric GF Flange Adaptors
 - Hardness: 70° Shore EPDM, 75° Shore FKM
 - EPDM: approved acc. to DVGW Water W 270, KTW recommendation
 - Centering on the inner diameter of the screw crown
 - material steel insert: carbon steel
 - Rubber-steel body combined with rubber profile cord ring
- di FA are the suitable inner diameters of flanges adaptors

d (mm)	PN (bar)	DN (mm)	EPDM Code	FKM Code	Weight (kg)	D (mm)	D1 (mm)	di FA (mm)	H (mm)	H1 (mm)
16	16	10	748 440 705	749 440 705	0.012	46	16	6 - 16	4	3
20	16	15	748 440 706	749 440 706	0.013	51	20	10 - 20	4	3
25	16	20	748 440 707	749 440 707	0.014	61	22	12 - 22	4	3
32	16	25	748 440 708	749 440 708	0.019	71	28	18 - 28	4	3
40	16	32	748 440 709	749 440 709	0.026	82	40	30 - 40	4	3
50	16	40	748 440 710	749 440 710	0.039	92	46	36 - 46	4	3
63	16	50	748 440 711	749 440 711	0.050	107	58	48 - 58	5	4
75	16	65	748 440 712	749 440 712	0.082	127	69	59 - 69	5	4
90	16	80	748 440 713	749 440 713	0.083	142	84	73 - 84	5	4
110	16	100		749 440 714	0.127	162	104	94 - 104	6	5

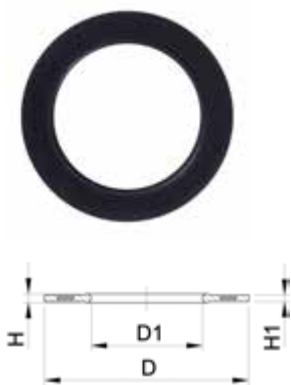

Profile flange gasket metric NBR

Model:

- NBR = Nitrile rubber, hardness approx. 80° Shore
- For all metric GF Flange Adaptors
- Rubber-steel body combined with rubber profile cord ring
- Approved acc. to DVGW standard DIN EN 682 for gas
- D corresponds to the centring at the inner diameter of the screw crown

d (mm)	DN (mm)	PN (bar)	NBR Code	Weight (kg)	D (mm)	D1 (mm)	H (mm)	H1 (mm)	di FA (mm)
20	15	16	745 440 706	0.009	51	20	4	3	10 - 20
25	20	16	745 440 707	0.012	61	22	4	3	12 - 22
32	25	16	745 440 708	0.018	71	28	4	3	18 - 28
40	32	16	745 440 709	0.021	82	40	4	3	30 - 40
50	40	16	745 440 710	0.029	92	46	4	3	36 - 46
63	50	16	745 440 711	0.039	107	58	5	4	48 - 58
75	65	16	745 440 712	0.058	127	69	5	4	59 - 69
90	80	16	745 440 713	0.063	142	84	5	4	73 - 84
110	100	16	745 440 714	0.096	162	104	6	5	94 - 104

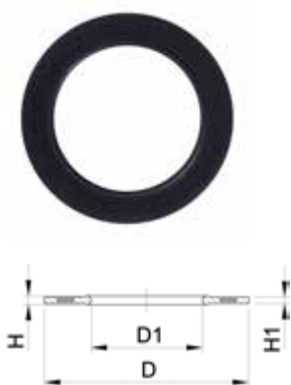

Profile flange gasket metric For flange adaptors without chamfer

Model:

- For flange adaptor No. 27 79 85 PP-H SDR11 without chamfer
- Profile Gasket with carbon steel insert (type G-ST-P/K)
- Hardness: 70° shore EPDM, 75° shore FKM

d (mm)	DN (mm)	PN (bar)	EPDM Code	Weight (kg)	FKM Code	Weight (kg)	D (mm)	D1 (mm)	di FA (mm)	H (mm)	H1 (mm)
20	15	16	748 440 706	0.009	749 440 706	0.013	51	20	10 - 20	4	3
25	20	16	748 440 707	0.015	749 440 707	0.014	61	22	12 - 22	4	3
32	25	16	748 440 708	0.013	749 440 708	0.019	71	28	18 - 28	4	3
40	32	16	748 440 709	0.019	749 440 709	0.026	82	40	30 - 40	4	3
50	40	16	748 440 710	0.029	749 440 710	0.039	92	46	36 - 46	4	3
63	50	16	748 440 711	0.041	749 440 711	0.050	107	58	48 - 58	5	4
75	65	16	748 440 712	0.053	749 440 712	0.082	127	69	59 - 69	5	4
90	80	16	748 440 713	0.064	749 440 713	0.083	142	84	73 - 84	5	4



O-Ring gasket

Model:

- For flange adaptors
- Hardness approx. 65° Shore

d (mm)	DN (mm)	EPDM Code	Weight (kg)	FKM Code	Weight (kg)	D (mm)	D1 (mm)	D2 (mm)	closest inch (inch)
16	10	748 410 000	0.002	749 410 000	0.005	26	19	3.53	3/8
20	15	748 410 001	0.002	749 410 001	0.002	31	23	3.53	1/2
25	20	748 410 007	0.002	749 410 007	0.002	35	28	3.53	3/4
32	25	748 410 002	0.003	749 410 002	0.003	43	36	3.53	1
40	32	748 410 003	0.004	749 410 003	0.002	55	44	5.34	1 1/4
50	40	748 410 012	0.004	749 410 012	0.008	64	53	5.34	1 1/2
63	50	748 410 013	0.006	749 410 013	0.011	80	69	5.34	2
75	65	748 410 014	0.007	749 410 014	0.012	93	82	5.34	2 1/2
90	80	748 410 015	0.008	749 410 015	0.015	112	101	5.34	3
110	100	748 410 016	0.016	749 410 016	0.031	134	120	6.99	4

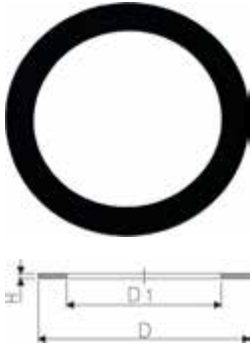

Flat gasket

Model:

- Hardness approx. 65° Shore
- For adaptor unions

Size (inch)	EPDM Code	Weight (kg)	FKM Code	Weight (kg)	D (mm)	D1 (mm)	H (mm)
¼	748 400 004	0.002			20	13	2
⅜	748 400 005	0.002	749 400 005	0.020	24	17	2
½	748 400 006	0.002	749 400 006	0.003	30	21	3
¾	748 400 007	0.003	749 400 007	0.004	38	27	3
1	748 400 008	0.002	749 400 008	0.002	44	32	3
1 ¼	748 400 009	0.007	749 400 009	0.003	55	42	3
1 ½	748 400 010	0.004	749 400 010	0.007	62	46	3
2	748 400 011	0.005	749 400 011	0.006	78	60	3
2 ½	748 400 012	0.010	749 400 012	0.009	97	75	3
3	748 400 013	0.011	749 400 013	0.011	109	88	3

Gaskets for butt fusion



Flat gasket EPDM

Model:

- For all metric GF Flange Adaptors
 - Hardness approx. 65° Shore
 - Integrated fixation aids from d110
 - Centering on the inner diameter of the screw crown
- di FA are the suitable inner diameters of flanges adaptors

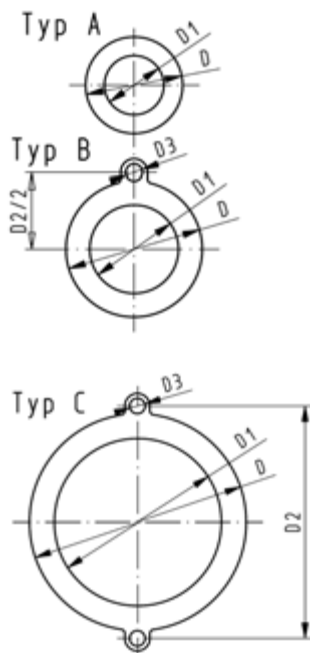

d (mm)	DN (mm)	PN (bar)	Type	EPDM Code	Weight (kg)	D (mm)	D1 (mm)	D2 (mm)	D3 (mm)	H (mm)	di FA (mm)
16	10	10	A	748 400 305	0.004	46	16			2	6 - 26
20	15	10	A	748 400 306	0.012	51	20			2	10 - 30
25	20	10	A	748 400 307	0.004	61	25			2	15 - 35
32	25	10	A	748 400 308	0.008	71	32			2	22 - 42
40	32	10	A	748 400 309	0.013	82	40			3	30 - 50
50	40	10	A	748 400 310	0.016	92	50			3	40 - 60
63	50	10	A	748 400 311	0.018	107	63			3	53 - 73
75	65	10	A	748 400 312	0.029	127	71			3	61 - 81
90	80	10	A	748 400 313	0.035	142	84			3	74 - 94
110	100	10	B	748 400 314	0.051	162	104	180	18	4	94 - 114
125	100	10	B	748 400 315	0.044	162	119	180	18	4	109 - 129
140	125	10	B	748 400 316	0.068	192	134	210	18	4	124 - 144
160 - 180	150	10	B	748 400 317	0.090	218	155	241	22	4	145 - 165
200	200	6	C	748 400 319	0.180	273	195	295	22	5	185 - 205
225	200	6	C	748 400 320	0.140	273	216	295	22	5	206 - 226
250	250	6	C	748 400 321	0.210	328	250	350	22	5	240 - 260
280	250	6	C	748 400 322	0.151	328	273	350	22	5	263 - 283
315	300	6	C	748 400 323	0.237	378	305	400	22	5	295 - 315



Flat gasket for flange adaptor

Model:

- Hardness: EPDM ca. 70° shore
- Flange bolt circle: PN10
- Integrated fixation aids
- Centering on the inner diameter of the screw crown

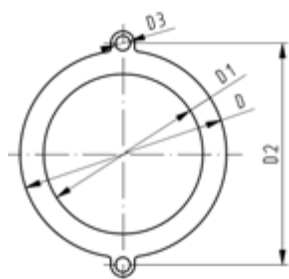

PN* (bar)	d (mm)	DN (mm)	EPDM Code	Weight (kg)	D2 (mm)	D3 (mm)	D1 (mm)	H (mm)	D (mm)
6	710	700	748 400 330	0.900	840	30	625	5	810
6	800	800	748 400 331	1.000	950	33	705	5	917
6	900	900	748 400 332	1.200	1050	36	805	5	1014
6	1000	1000	748 400 333	1.400	1160	39	890	5	1121

Profile Flange Gasket, metric EPDM / FKM

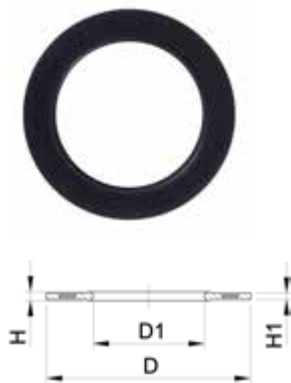

Model:

- For all metric GF Flange Adaptors
 - Hardness: 70° Shore EPDM, 75° Shore FKM
 - EPDM: approved acc. to DVGW Water W 270, KTW recommendation
 - Centering on the inner diameter of the screw crown
 - material steel insert: carbon steel
 - Rubber-steel body combined with rubber profile cord ring
- di FA are the suitable inner diameters of flanges adaptors

d (mm)	PN (bar)	DN (mm)	EPDM Code	FKM Code	Weight (kg)	D (mm)	D1 (mm)	di FA (mm)	H (mm)	H1 (mm)
16	16	10	748 440 705	749 440 705	0.012	46	16	6 - 16	4	3
20	16	15	748 440 706	749 440 706	0.013	51	20	10 - 20	4	3
25	16	20	748 440 707	749 440 707	0.014	61	22	12 - 22	4	3
32	16	25	748 440 708	749 440 708	0.019	71	28	18 - 28	4	3
40	16	32	748 440 709	749 440 709	0.026	82	40	30 - 40	4	3
50	16	40	748 440 710	749 440 710	0.039	92	46	36 - 46	4	3
63	16	50	748 440 711	749 440 711	0.050	107	58	48 - 58	5	4
75	16	65	748 440 712	749 440 712	0.082	127	69	59 - 69	5	4
90	16	80	748 440 713	749 440 713	0.083	142	84	73 - 84	5	4
110	16	100	748 440 714	749 440 714	0.127	162	104	94 - 104	6	5
125	16	100	748 440 715	749 440 715	0.105	162	123	113 - 123	6	5
140	16	125	748 440 716	749 440 716	0.173	192	137	127 - 137	6	5
160 - 180	16	150	748 440 717	749 440 717	0.207	218	160	150 - 160	8	6
200	16	200	748 440 719	749 440 719	0.263	273	203	192 - 203	8	6
225	16	200	748 440 720	749 440 720	0.255	273	220	207 - 220	8	6
250	16	250	748 440 721	749 440 721	0.462	328	252	238 - 252	8	6
280	16	250	748 440 722	749 440 722	0.323	328	274	264 - 274	8	6
315	16	300	748 440 723	749 440 723	0.549	378	306	296 - 306	8	6
355	16	350	748 440 724	749 440 724	0.870	438	355	340 - 355	10	7
400	16	400	748 440 725	749 440 725	1.088	489	400	385 - 400	10	7
450	16	500	748 440 726	749 440 726	0.718	594	403	393 - 403	10	7
500	16	500	748 440 727	749 440 727	0.718	594	447	437 - 447	10	7
560	16	600	748 440 728	749 440 728	0.923	695	494	484 - 494	10	7
630	16	600	748 440 729	749 440 729	0.923	695	555	545 - 555	10	7

Profile flange gasket metric NBR

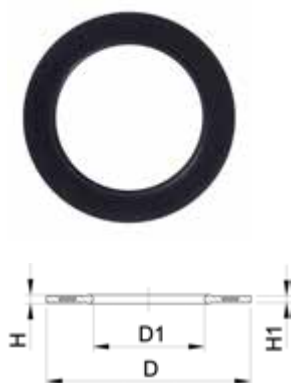

Model:

- NBR = Nitrile rubber, hardness approx. 80° Shore
- For all metric GF Flange Adaptors
- Rubber-steel body combined with rubber profile cord ring
- Approved acc. to DVGW standard DIN EN 682 for gas
- D corresponds to the centring at the inner diameter of the screw crown

d (mm)	DN (mm)	PN (bar)	NBR Code	Weight (kg)	D (mm)	D1 (mm)	H (mm)	H1 (mm)	di FA (mm)
20	15	16	745 440 706	0.009	51	20	4	3	10 - 20
25	20	16	745 440 707	0.012	61	22	4	3	12 - 22
32	25	16	745 440 708	0.018	71	28	4	3	18 - 28
40	32	16	745 440 709	0.021	82	40	4	3	30 - 40
50	40	16	745 440 710	0.029	92	46	4	3	36 - 46
63	50	16	745 440 711	0.039	107	58	5	4	48 - 58
75	65	16	745 440 712	0.058	127	69	5	4	59 - 69
90	80	16	745 440 713	0.063	142	84	5	4	73 - 84
110	100	16	745 440 714	0.096	162	104	6	5	94 - 104
125	100	16	745 440 715	0.073	162	123	6	5	113 - 123
140	125	16	745 440 716	0.128	192	137	6	5	127 - 137
160 - 180	150	16	745 440 717	0.145	218	160	8	6	150 - 160
200	200	16	745 440 719	0.286	273	203	8	6	192 - 203
225	200	16	745 440 720	0.183	273	220	8	6	207 - 220

table continued on the next page

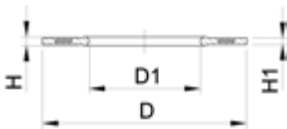

d (mm)	DN (mm)	PN (bar)	NBR Code	Weight (kg)	D (mm)	D1 (mm)	H (mm)	H1 (mm)	di FA (mm)
250	250	16	745 440 721	0.355	328	252	8	6	238 - 252
280	250	16	745 440 722	0.229	328	274	8	6	264 - 274
315	300	16	745 440 723	0.419	378	306	8	6	296 - 306
355	350	16	745 440 724	0.645	438	355	10	7	340 - 355
400	400	16	745 440 725	0.819	489	400	10	7	385 - 400
450	500	16	745 440 726	1.885	594	403	10	7	393 - 403
500	500	16	745 440 727	1.618	594	447	10	7	437 - 447
560	600	16	745 440 728	2.281	695	494	10	7	484 - 494
630	600	16	745 440 729	2.000	695	555	10	7	545 - 555

Profile Flange Gaskets ANSI



Model:

- Suitable for flanges adaptors PP/PE PVDF
- Hardness: 70° Shore EPDM, 75° Shore FKM
- Centered by the flange bolts
- Dimension D is in accordance with the inner diameter of the bolt circle

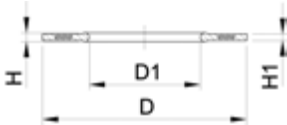

d (mm)	EPDM Code	Weight (kg)	FKM Code	Weight (kg)	Inch	DN (mm)	D (mm)	D1 (mm)	H (mm)	H1 (mm)
25	748 440 502	0.010	749 440 502	0.011	3/4	20	54	27	4	3
32	748 440 503	0.011	749 440 503	0.023	1	25	64	33	4	3
40	748 440 504	0.017	749 440 504	0.024	1 1/4	32	73	42	4	3
50	748 440 505	0.030	749 440 505	0.030	1 1/2	40	83	48	4	3
63	748 440 506	0.029	749 440 506	0.042	2	50	102	60	5	4
75	748 440 507	0.046	749 440 507	0.068	2 1/2	65	121	73	5	4
90	748 440 508	0.053	749 440 508	0.083	3	80	133	89	5	4
110	748 440 509	0.088	749 440 509	0.139	4	100	171	115	6	5
160 - 180	748 440 512	0.127	749 440 512	0.240	6	150	222	160	8	6
225	748 440 515	0.195	749 440 515	0.316	8	200	279	220	8	6
250	748 440 517	0.243	749 440 517	0.373	10	250	337	273	8	6
315	748 440 518	0.398	749 440 518	0.750	12	300	406	325	8	6
355	748 440 519	0.800	749 440 519	0.800	14	350	448	356	10	7
400	748 440 520	0.900	749 440 520	0.900	16	400	512	406	10	7
450	748 440 521	1.000	749 440 521	1.000	18	450	547	457	10	7
500	748 440 522	1.000	749 440 522	1.000	20	500	604	508	10	7

Reliable to the extreme

Underground PE systems for fire protection

FM Approvals is an internationally recognized certification organization which tests and certifies components for fire protection systems. Any GF product that is FM Approved is guaranteed to meet rigorous loss prevention standards of quality, technical integrity and performance. The manufacturing processes and the in-house testing facilities at GF have been inspected by FM Approvals, and are audited on a frequent basis to ensure compliance and continuous improvement.

Go beyond the core benefits of HDPE pipes

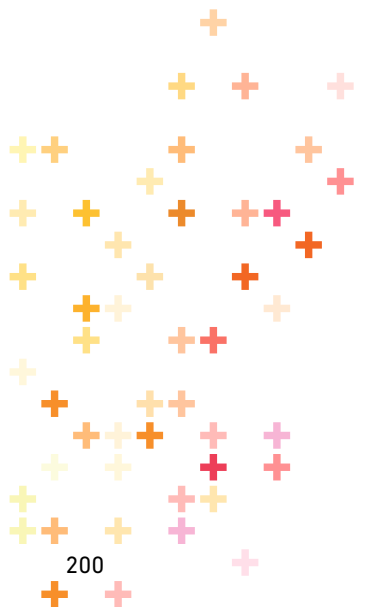
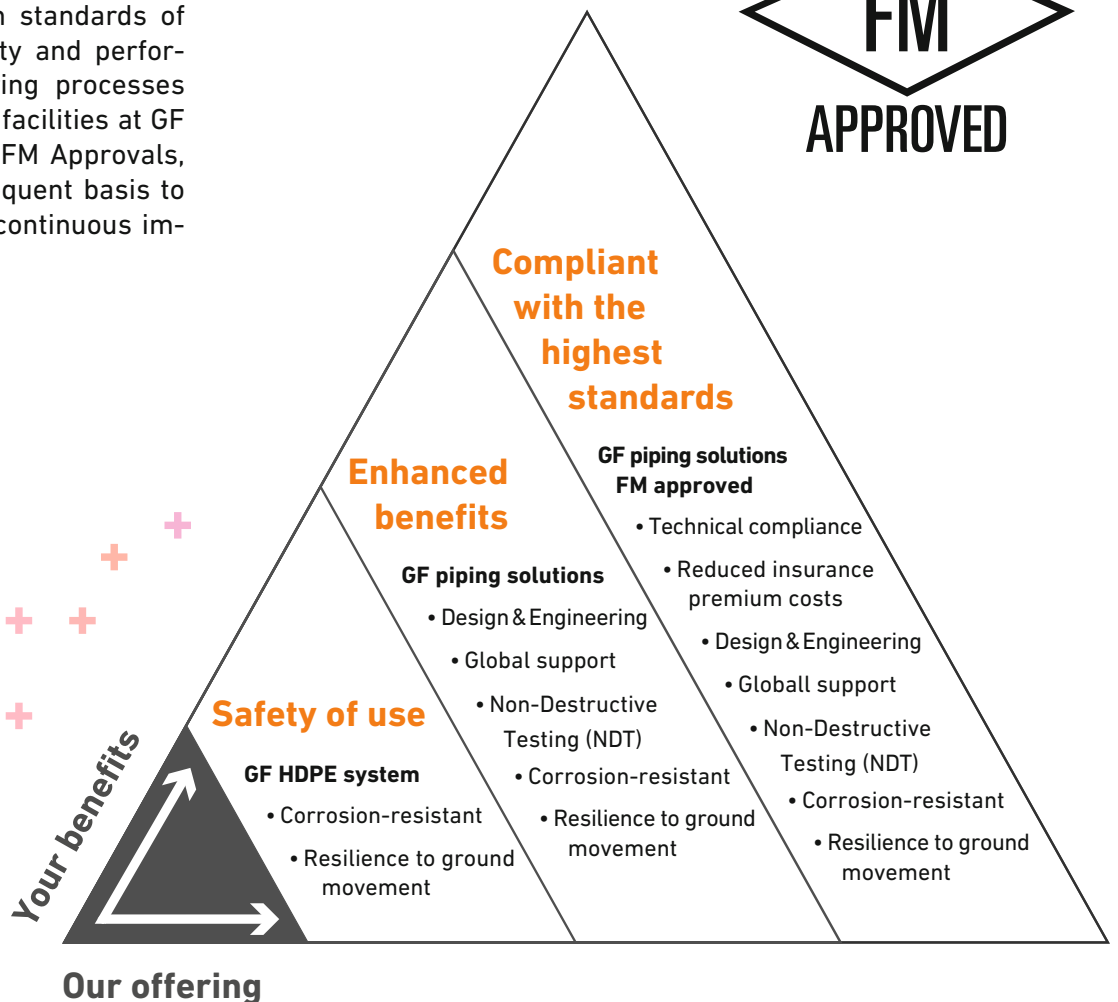

Overview of our FM-approved products

+ Now the details



Product	FM class 12 bar	Class 200 14 bar	FM class 15 bar	Class 250 17.24 bar	Class 335 23 bar
Pipe	110 - 400 mm	2 - 24"	90 - 500 mm	2 - 24"	4 - 24"
Spigot fittings for electro fusion ** (ISO/DIN)					
Bend / Elbow 45°	355 - 500 mm		90 - 315 mm		
Bend / Elbow 90°	355 - 500 mm		90 - 315 mm		
Tee 90° equal	355 - 500 mm		90 - 315 mm		
End cap	355 - 500 mm		90 - 315 mm		
Flange adapter	355 - 500 mm		90 - 315 mm		
Backing ring					
Reducer	400 - 355 mm		90 - 355 mm		
ELGEF fittings (ISO/DIN)					
Coupler			90 - 500 mm		
Branch saddle			110 - 630 mm (branch 90 - 125 mm)		
Spigot fittings for butt fusion (ASTM)					
45° Elbows		2 - 24"		2 - 24"	4 - 24"
90° Elbows		2 - 24"		2 - 24"	4 - 24"
22.5° Elbows		2 - 24"		2 - 24"	4 - 24"
Tee equal		4 - 24"		4 - 24"	4 - 24"
Tee reduced branch		2 - 24"		2 - 24"	4 - 24"
Flange adaptor		2 - 36"		2 - 36"	4 - 24"
Backing ring		2 - 36"		2 - 36"	4 - 24"
Reducer		2 - 24"		2 - 24"	4 - 24"
Branch saddle		main* 2 - 12 " outlet		main* 2 - 12 " outlet	
Anchor ring		2 - 24"		2 - 24"	4 - 24"
Mechanical joint adaptor		2 - 24"		2 - 24"	4 - 24"

The technical data are not binding. They neither constitute expressly warranted characteristics nor guaranteed properties nor a guaranteed durability. They are subject to modification. Our General Terms of Sale apply.

* Available in Butt Fusion and Electrofusion, size dependent
 ** Spigot fittings (ISO/DIN) can only be installed using electrofusion
 Note Inch sizes are Iron Pipe sizes (IPS) and Ductile Pipe Sizes (DPS) equivalent

Metric Product Range



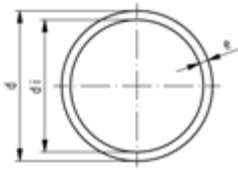

ecoFIT pipe FM Approval PN16/S5/SDR11 5m/12m

Model:

- Material: PE 100
 - Dimension: acc. to DIN 8074/75
 - Colour: black
 - Pipe length: 5000mm or 12000mm, with plain ends
 - Approval: FM approval Standard 1613
 - Attention: Pressure rates refer to operating temperatures at 20°C. Higher temperatures and aggressive flow media reduce pressure load (see above DIN and our technical documentaion). Pressure load capacity has to be determined in consideration with safety demands of the respective applications and calculated in accordance.
 - Note 1: SDR 11 / PN 16 / S 5 5000mm Length
 - Note 2: SDR 11 / PN 16 / S 5 12000mm Length
- * Only special production

Note	d (mm)	Code	Weight (kg/m)	e (mm)	di (mm)	FM PN (bar)	Length (m)	
1	110	316 110 022	3.180	10.0	90.0	12	5	
1	125	316 125 029	4.120	11.4	102.8	12	5	
1	140	316 140 018	5.130	12.7	114.6	12	5	
1	160	316 160 020	6.740	14.6	130.8	12	5	
1	180	316 180 019	8.510	16.4	147.2	12	5	
1	200	316 200 012	10.500	18.2	163.6	12	5	
1	225	316 225 009	13.300	20.5	184.0	12	5	
1	250	316 250 005	16.300	22.7	204.6	12	5	
1	280	316 280 019	20.500	25.4	229.2	12	5	
1	315	316 315 008	25.900	28.6	257.8	12	5	
1	355	316 355 017	32.900	32.2	290.6	12	5	
1	400	316 400 008	41.700	36.3	327.4	12	5	
*	2	110	316 110 039	3.180	10.0	90.0	12	12
*	2	125	316 125 031	4.120	11.4	102.8	12	12
*	2	140	316 140 027	5.130	12.7	114.6	12	12
*	2	160	316 160 019	6.730	14.6	130.8	12	12
*	2	180	316 180 020	8.510	16.4	147.2	12	12
*	2	200	316 200 014	10.500	18.2	163.6	12	12
*	2	225	316 225 010	13.300	20.5	184.0	12	12
*	2	250	316 250 009	16.300	22.7	204.6	12	12
*	2	280	316 280 024	20.500	25.4	229.2	12	12
*	2	315	316 315 009	25.900	28.6	257.8	12	12
*	2	355	316 355 020	32.900	32.2	290.6	12	12
*	2	400	316 400 010	41.700	36.3	327.4	12	12

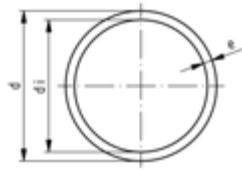

ecoFIT pipe SDR9

Model:

- Material: PE100

d (mm)	Code	e (mm)	di (mm)	FM PN (bar)
90	on request	10.0	90.0	15
110	on request	10.0	90.0	15
125	on request	11.4	102.8	15
140	on request	12.7	114.6	15
160	on request	14.6	130.8	15
180	on request	16.4	147.2	15
200	on request	18.2	163.6	15
225	on request	20.5	184.0	15
250	on request	22.7	204.6	15
280	on request	25.4	229.2	15
315	on request	28.6	257.8	15
355	on request	32.2	290.6	15
400	on request	36.3	327.4	15
450	on request	40.9	368.2	15
500	on request	40.9	368.2	15

Coupler

- PE 100 SDR 11 (ISO S5)
- 4 mm pin connectors
- Limited path fusion indicators
- Removable centre stop up to d160

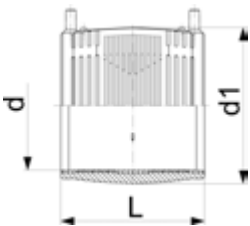

d (mm)	Code	Weight (kg)	d1 (mm)	L (mm)	FM PN (bar)
90	753 911 613	0.406	113	125	15
110	753 911 614	0.692	138	145	15
125	753 911 615	0.718	154	156	15
140	753 911 616	0.945	172	166	15
160	753 911 617	1.362	196	180	15
180	753 911 618	1.747	219	192	15
200	753 911 619	1.866	244	208	15
225	753 911 620	3.329	273	225	15
250	753 911 621	4.678	304	248	15
280	753 911 622	7.500	340	252	15
315	753 911 623	8.142	382	267	15

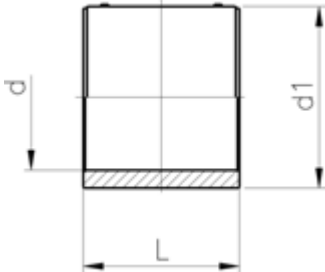

Coupler

- PE 100 SDR 11 (ISO S5)
- 4 mm pin connectors
- Limited path fusion indicators
- With active reinforcement

d (mm)	Code	Weight (kg)	d1 (mm)	L (mm)	FM PN (bar)
355	753 911 704	13.098	438	291	15
400	753 911 705	18.320	493	295	15
450	753 911 706	24.700	554	327	15
500	753 911 707	33.700	616	358	15

Elbow 90° PE 100 SDR11

- Long spigot version
- FM approved in combination with electro fusion

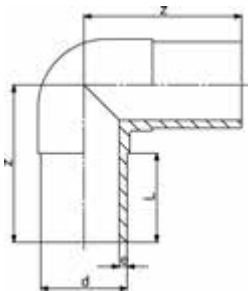

d (mm)	Code	Weight (kg)	z (mm)	L (mm)	e (mm)	FM PN (bar)
90	753 101 013	0.704	150	81	8.2	15
110	753 101 014	1.158	165	86	10.0	15
125	753 101 015	1.609	180	92	11.4	15
140	753 101 016	2.270	194	92	12.7	15
160	753 101 017	3.100	210	102	14.6	15
180	753 101 018	4.328	232	107	16.4	15
200	753 101 019	5.739	253	117	18.2	15
225	753 101 020	7.775	270	122	20.5	15
250	753 101 001	10.506	292	130	22.7	15
280	753 100 922	15.059	320	140	25.4	15
315	753 100 923	21.960	370	150	28.6	15

Elbow 45° PE100 SDR11

- Long spigot version
- FM approved in combination with electro fusion

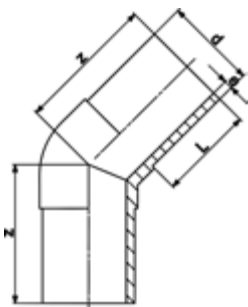

d (mm)	Code	Weight (kg)	z (mm)	L (mm)	e (mm)	FM PN (bar)
90	753 151 013	0.565	120	81	8.2	15
110	753 151 014	0.921	130	86	10.0	15
125	753 151 015	1.290	140	92	11.4	15
140	753 151 016	1.796	164	120	12.7	15
160	753 151 017	2.454	162	102	14.6	15
180	753 151 018	3.274	170	107	16.4	15
200	753 151 019	4.362	186	116	18.2	15
225	753 151 020	5.981	200	123	20.5	15
250	753 151 021	8.283	220	130	22.7	15
280	753 150 922	10.285	230	140	25.4	15
315	753 150 923	14.124	250	150	28.6	15



Tee 90° PE 100 SDR11

- Long spigot version
- FM approved in combination with electro fusion
- 10 bar Gas / 16 bar Water

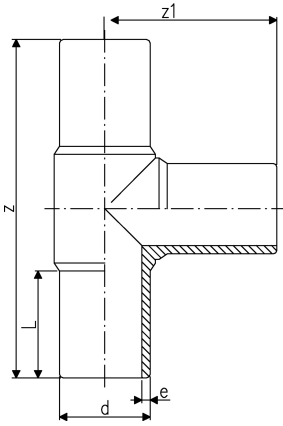

d (mm)	Code	Weight (kg)	z (mm)	L (mm)	e (mm)	FM PN (bar)	z1 (mm)
90	753 201 013	1.021	300	81	8.2	15	150
110	753 201 014	1.612	330	86	10.0	15	165
125	753 201 015	2.420	366	92	11.4	15	183
140	753 201 016	3.090	393	92	12.7	15	193
160	753 201 017	4.403	420	102	14.6	15	210
180	753 201 018	6.014	460	107	16.4	15	230
200	753 201 019	8.480	500	117	18.2	15	250
225	753 201 020	11.507	540	122	20.5	15	270
250	753 201 001	14.099	575	130	22.7	15	288
280	753 200 902	18.670	615	139	25.4	15	308
315	753 200 903	26.150	695	150	28.6	15	346

Type B

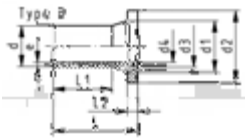
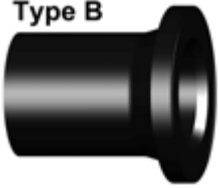

Flange adaptor LS PE100 SDR11

Combined jointing face:
Flat and serrated

Model:

- Long spigot
- Material: PE100
- For IR, butt- and electro fusion
- Suitable for flange connections to metric (from d110 also to ANSI/ASME B16.5)
- Up to d280, suitable for butterfly valve type 037/038/039. Above use ecoFIT adaptor for butterfly valves SDR17.6 (d315-d800)
- Up to d315, suitable for butterfly valve type 567/578 and 038/039. Above use ecoFIT adaptor for butterfly valves SDR11 (d355-d800)
- Gasket d20-d630: Profile flange gasket NBR No. 45 44 07, EPDM No. 48 44 07
- Gasket d710-d1000: flat gasket EPDM No. 48 40 03
- 10 bar Gas / 16 bar Water

* Type B with chamfer

- FM approved in combination with electro fusion

d (mm)	DN (mm)	Code	Weight (kg)	d1 (mm)	d2 (mm)	d3 (mm)	d4 (mm)	L (mm)	L1 (mm)	L2 (mm)	e (mm)	Type	FM PN (bar)
90	80	753 800 013	0.471	105	138	78	73	140	103	17	8	B	15
110	100	753 800 014	0.706	125	158	100	90	160	114	18	10	B	15
125	100	753 800 015	0.883	132	158	114	102	170	125	25	11	B	15
140	125	753 800 016	1.348	155	188	127	114	200	147	25	13	B	15
160	150	753 800 017	1.718	175	212	151	130	200	147	25	15	B	15
180	150	753 800 018	2.035	180	212	158	147	200	170	30	16	B	15
200	200	753 800 019	2.899	232	268	203	163	200	128	32	18	B	15
225	200	753 800 020	3.208	235	268	210	184	200	138	32	21	B	15
250	250	753 800 021	4.878	285	320	245	204	219	138	35	23	B	15
280	250	753 800 022	4.925	291	320	265	229	231	144	35	25	B	15
315	300	753 800 023	7.135	335	370	300	257	239	158	35	29	B	15
355	350	753 800 224	10.400	373	430	342	284	267	170	40	32	B	15
400	400	753 800 225	14.500	427	482	387	320	292	185	46	36	B	15
450	500	753 800 226	23.700	514	585	400	360	330	205	60	41	B	15
500	500	753 800 227	27.100	530	585	442	400	351	220	60	46	B	15

Reducer PE100 SDR11

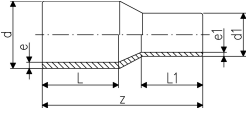

- Long spigot version
- FM approved in combination with electro fusion

d (mm)	d1 (mm)	Code	Weight (kg)	z (mm)	L (mm)	L1 (mm)	e (mm)	e1 (mm)	FM PN (bar)
110	90	753 901 076	0.549	205	86	81	10.0	8,2	15
125	90	753 901 081	0.683	212	92	81	11.4	8,2	15
125	110	753 901 080	0.775	212	92	86	11.4	10,0	15
140	90	753 901 087	0.954	230	110	79	12.7	8,2	15
140	110	753 901 084	0.977	234	110	88	12.7	10,0	15
140	125	753 901 085	1.078	235	110	90	12.7	11,4	15
160	90	753 901 088	1.164	244	120	79	14.6	8,2	15
160	110	753 901 090	1.239	244	102	86	14.6	10,0	15
160	125	753 901 089	1.333	245	102	92	14.6	11,4	15
160	140	753 901 032	1.522	260	120	110	14.6	12,7	15
180	90	753 901 073	1.507	245	105	79	16.4	8,2	15
180	110	753 901 074	1.833	270	105	82	16.4	10,0	15
180	125	753 901 091	1.723	258	107	92	16.4	11,4	15
180	140	753 901 075	1.976	270	120	110	16.4	12,7	15
180	160	753 901 033	1.968	255	107	102	16.4	14,6	15
200	140	753 901 066	2.326	275	120	110	18.2	12,7	15
200	160	753 901 092	2.435	265	117	102	18.2	14,6	15
200	180	753 901 034	2.724	265	117	107	18.2	16,4	15
225	140	753 901 067	2.900	295	130	110	20.5	12,7	15
225	160	753 901 096	2.891	178	120	98	20.5	14,6	15
225	180	753 901 095	3.244	280	122	107	20.5	16,4	15
225	200	753 901 094	3.538	280	122	117	20.5	18,2	15
250	160	753 901 000	2.385	300	130	100	22.7	14,6	15
250	180	753 901 068	4.299	295	130	105	22.7	16,4	15
250	200	753 901 001	4.766	315	130	112	22.7	18,2	15
250	225	753 901 002	2.385	332	130	120	22.7	20,5	15
280	200	753 901 098	6.850	333	140	112	25.4	18,2	15
280	225	753 901 099	6.112	335	140	120	25.4	20,5	15
280	250	753 901 003	2.385	340	140	130	25.4	22,7	15
315	200	753 901 004	7.522	380	180	134	28.6	18,2	15
315	225	753 901 097	7.790	365	150	120	28.6	20,5	15
315	250	753 901 005	8.360	365	150	130	28.6	22,7	15
315	280	753 901 012	8.800	365	150	139	28.6	25,4	15
355	250	753 901 013	9.100	390	165	130	32.3	22,7	15
355	280	753 901 014	9.500	390	165	139	32.3	25,4	15
355	315	753 901 015	9.900	390	165	150	32.3	28,6	15
400	355	753 901 018	11.600	420	180	165	36.4	32,3	12

Cap PE100 SDR11



- Long spigot version
- FM approved in combination with electro fusion

Note:

* Fabricated fitting made from pipe

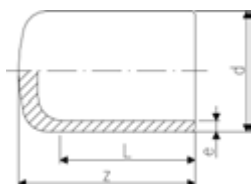

d (mm)	Code	Weight (kg)	z (mm)	L (mm)	e (mm)	FM PN (bar)
90	753 961 013	0.240	90	81	8.2	15
110	753 961 014	0.373	98	86	10.0	15
125	753 961 015	0.546	105	92	11.4	15
140	753 961 016	0.727	136	92	12.7	15
160	753 961 017	1.034	120	102	14.6	15
180	753 961 018	1.351	128	107	16.4	15
200	753 961 019	1.845	138	115	18.2	15
225	753 961 020	2.514	148	122	20.5	15
250	753 961 021	3.927	205	130	22.7	15
280	753 960 922	8.045	235	139	25.4	15
315	753 960 923	6.861	255	150	28.6	15
355	753 960 924	9.780	280	165	32.3	12
400	753 960 925	13.370	310	180	36.4	12
450	753 960 926	20.800	275	195	40.9	12
500	753 960 927	28.400	297	212	45.5	12

Branch saddle outlet 90 - 125 mm

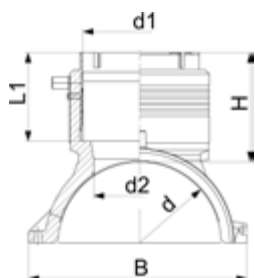

- PE 100 SDR 11 (ISO S5)
 - Branch Saddle complete, incl. lower part and 3 screws
 - Additional fixing with snatch hinge
 - Electrofusion outlet with integrated pipe fixation
 - Protected wire without medium contact
 - 4 mm pin connectors
 - Limited path fusion indicators
- * Delivered without lower part. Pipe fixation with multiple use assembly toolno. 193.281.027

d (mm)	d1 (mm)	Code	Weight (kg)	H (mm)	L (mm)	L1 (mm)	B (mm)	d2 (mm)	FM PN (bar)	SDR pipe	
110	90	193 135 009	1.124	101	220	82	164	65	15	9-17.6	
110	110	193 135 010	1.224	107	220	88	164	65	15	9-17.6	
125	90	193 135 019	1.134	101	220	82	179	65	15	9-17.6	
125	110	193 135 020	1.290	107	220	88	179	65	15	9-17.6	
*	140	90	193 135 029	0.982	101	220	81	195	65	15	9-17.6
*	140	110	193 135 030	1.087	107	220	87	195	65	15	9-17.6
	160	90	193 135 039	1.449	102	240	82	215	65	15	9-17.6
	160	110	193 135 040	1.582	108	240	88	215	86	15	9-17.6
	160	125	193 135 041	1.782	129	240	99	215	86	15	9-17.6
	180	90	193 135 049	1.672	102	260	82	237	65	15	9-17.6
	180	110	193 135 050	1.765	108	260	88	237	86	15	9-17.6
	180	125	193 135 051	2.015	129	260	99	237	86	15	9-17.6
	200	90	193 135 059	1.803	102	260	82	253	65	15	9-17.6
	200	110	193 135 060	1.963	108	260	88	253	86	15	9-17.6
	200	125	193 135 061	2.128	129	260	99	253	86	15	9-17.6
	225	90	193 135 069	2.006	102	260	82	287	65	15	9-17.6
	225	110	193 135 070	2.400	108	260	88	287	86	15	9-17.6
	225	125	193 135 071	2.312	129	260	99	287	86	15	9-17.6
	250	90	193 135 079	2.145	102	260	82	312	65	15	9-17.6
	250	110	193 135 080	2.258	108	260	88	312	86	15	9-17.6
	250	125	193 135 081	2.500	129	260	99	312	86	15	9-17.6

Branch saddle topload outlet 90 - 125 mm

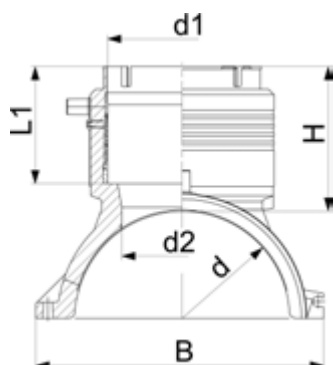

- PE 100 SDR 11 (ISO S5)
- Branch Saddle for assembling as Topload with tool 799.350.477; angle adaptors (799.350.340) for fusion cable required
- Electrofusion outlet with integrated pipe fixation
- Protected wire without medium contact
- 4 mm pin connectors
- Limited path fusion indicators

d (mm)	d1 (mm)	Code	Weight (kg)	H (mm)	L (mm)	L1 (mm)	B (mm)	d2 (mm)	SDR pipe	FM PN (bar)
280	90	193 135 289	1.242	102	260	82	243	65	9-26	15
280	110	193 135 290	1.295	108	260	88	243	86	9-26	15
280	125	193 135 291	1.530	129	260	99	243	86	9-26	15
315 - 355	90	193 135 309	1.214	102	260	82	249	65	9-26	15
315 - 355	110	193 135 310	1.297	108	260	88	249	86	9-26	15
315 - 355	125	193 135 311	1.530	129	260	99	249	86	9-26	15
400	90	193 135 329	1.022	102	260	82	256	65	9-26	15
400	110	193 135 330	1.116	108	260	88	256	86	9-26	15
400	125	193 135 331	1.369	129	260	99	256	86	9-26	15
450	90	193 135 339	1.022	102	260	82	256	65	9-26	15
450	110	193 135 340	1.116	108	260	88	256	86	9-26	15
450	125	193 135 341	1.369	129	260	99	256	86	9-26	15
500 - 630	90	193 135 159	1.086	102	260	82	263	65	9-26	15
500 - 630	110	193 135 160	1.159	108	260	88	263	86	9-26	15
500 - 630	125	193 135 161	1.388	129	260	99	263	86	9-26	15

Bend 90°

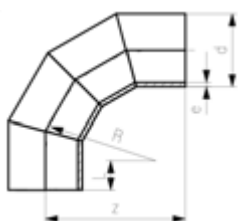

Model:

- Material: PE100

d (mm)	Code	z (mm)	L (mm)	R (mm)	e (mm)	FM PN (bar)
355	on request	1415	350	1065	42.1	12
400	on request	1550	350	1200	47.4	12
450	on request	1700	350	1350	53.3	12
500	on request	1900	400	1500	59.3	12



Bend 45°

Model:

- Material: PE100

d (mm)	Code	z (mm)	L (mm)	R (mm)	e (mm)	FM PN (bar)
355	on request	792	350	1065	42.1	12
400	on request	847	350	1200	47.4	12
450	on request	960	350	1350	53.3	12
500	on request	1022	400	1500	59.3	12

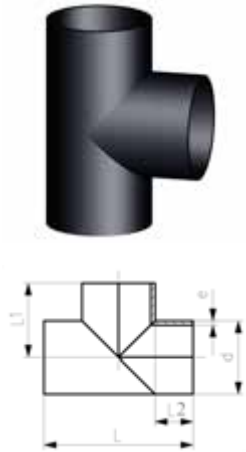

Tee 90° equal

Model:

- Material: PE100

d (mm)	Code	L (mm)	L1 (mm)	L2 (mm)	e (mm)	FM PN (bar)
355	on request	1410	705	350	42.1	12
400	on request	1500	750	350	47.4	12
450	on request	1700	850	400	53.3	12
500	on request	2040	1020	520	59.3	12

Code Index

Index

Code	Page	Code	Page	Code	Page	Code	Page
160 050 520	92	161 546 786	132	161 567 025	143	167 514 334	159
160 050 521	92	161 546 787	132	161 567 026	143	167 514 335	159
160 050 522	92	161 546 792	132	161 567 027	143	167 514 336	159
160 050 523	92	161 546 793	132	161 567 028	143	167 514 337	159
160 050 620	92	161 546 794	132	161 567 029	143	167 543 122	156
160 050 621	92	161 546 795	132	161 567 030	143	167 543 123	156
160 050 622	92	161 546 796	132	161 578 002	144	167 543 124	156
160 050 623	92	161 546 797	132	161 578 003	144	167 543 125	156
161 514 212	141	161 546 805	134	161 578 004	144	167 543 126	156
161 514 213	141	161 546 806	134	161 578 005	144	167 543 127	156
161 514 214	141	161 546 807	134	161 578 006	144	167 543 132	156
161 514 215	141	161 546 815	134	161 578 007	144	167 543 133	156
161 514 216	141	161 546 816	134	161 578 008	144	167 543 134	156
161 514 217	141	161 546 817	134	161 578 009	144	167 543 135	156
161 514 312	142	161 546 822	133	161 578 010	144	167 543 136	156
161 514 313	142	161 546 823	133	161 578 022	144	167 543 137	156
161 514 314	142	161 546 824	133	161 578 023	144	167 543 322	157
161 514 315	142	161 546 825	133	161 578 024	144	167 543 323	157
161 514 316	142	161 546 826	133	161 578 025	144	167 543 324	157
161 514 317	142	161 546 827	133	161 578 026	144	167 543 325	157
161 543 462	139	161 546 828	133	161 578 027	144	167 543 326	157
161 543 463	139	161 546 829	133	161 578 028	144	167 543 327	157
161 543 464	139	161 546 830	133	161 578 029	144	167 543 332	157
161 543 465	139	161 546 832	133	161 578 030	144	167 543 333	157
161 543 466	139	161 546 833	133	161 591 121	147	167 543 334	157
161 543 467	139	161 546 834	133	161 591 122	147	167 543 335	157
161 543 472	139	161 546 835	133	161 591 123	147	167 543 336	157
161 543 473	139	161 546 836	133	161 591 124	147	167 543 337	157
161 543 474	139	161 546 837	133	161 591 125	147	167 546 126	152
161 543 475	139	161 546 838	133	161 591 126	147	167 546 127	152
161 543 476	139	161 546 839	133	161 591 127	147	167 546 136	152
161 543 477	139	161 546 840	133	161 591 128	147	167 546 137	152
161 543 482	140	161 561 142	145	161 591 129	147	167 546 142	151
161 543 483	140	161 561 143	145	161 591 130	147	167 546 143	151
161 543 484	140	161 561 144	145	161 591 131	147	167 546 144	151
161 543 485	140	161 561 145	145	161 591 132	147	167 546 145	151
161 543 486	140	161 561 146	145	161 591 133	147	167 546 146	151
161 543 487	140	161 561 147	145	161 591 134	147	167 546 147	151
161 543 492	140	161 561 148	145	161 591 135	147	167 546 152	151
161 543 493	140	161 561 149	145	161 591 136	147	167 546 153	151
161 543 494	140	161 561 150	145	161 591 137	147	167 546 154	151
161 543 495	140	161 562 142	146	161 591 138	147	167 546 155	151
161 543 496	140	161 562 143	146	167 514 212	158	167 546 156	151
161 543 497	140	161 562 144	146	167 514 213	158	167 546 157	151
161 546 761	131	161 562 145	146	167 514 214	158	167 546 161	154
161 546 762	131	161 562 146	146	167 514 215	158	167 546 162	154
161 546 763	131	161 562 147	146	167 514 216	158	167 546 163	154
161 546 764	131	161 562 148	146	167 514 217	158	167 546 164	154
161 546 765	131	161 562 149	146	167 514 232	158	167 546 165	154
161 546 766	131	161 562 150	146	167 514 233	158	167 546 166	154
161 546 767	131	161 567 002	143	167 514 234	158	167 546 167	154
161 546 771	131	161 567 003	143	167 514 235	158	167 546 171	154
161 546 772	131	161 567 004	143	167 514 236	158	167 546 172	154
161 546 773	131	161 567 005	143	167 514 237	158	167 546 173	154
161 546 774	131	161 567 006	143	167 514 312	159	167 546 174	154
161 546 775	131	161 567 007	143	167 514 313	159	167 546 175	154
161 546 776	131	161 567 008	143	167 514 314	159	167 546 176	154
161 546 777	131	161 567 009	143	167 514 315	159	167 546 177	154
161 546 782	132	161 567 010	143	167 514 316	159	167 546 282	153
161 546 783	132	161 567 022	143	167 514 317	159	167 546 283	153
161 546 784	132	161 567 023	143	167 514 332	159	167 546 284	153
161 546 785	132	161 567 024	143	167 514 333	159	167 546 285	153

Index

Code	Page	Code	Page	Code	Page	Code	Page
167 546 286	153	167 567 009	160	173 103 177	92	193 017 313	99
167 546 287	153	167 567 010	160	173 103 185	92	193 017 314	99
167 546 288	153	167 567 022	160	173 103 186	92	193 017 315	99
167 546 289	153	167 567 023	160	173 103 187	92	193 017 316	99
167 546 290	153	167 567 024	160	173 103 195	93	193 017 317	99
167 546 292	153	167 567 025	160	173 103 196	93	193 017 318	99
167 546 293	153	167 567 026	160	173 281 925	38	193 017 319	99
167 546 294	153	167 567 027	160	193 017 107	102	193 017 320	99
167 546 295	153	167 567 028	160	193 017 108	102	193 017 321	99
167 546 296	153	167 567 029	160	193 017 109	102	193 017 322	99
167 546 297	153	167 567 030	160	193 017 110	102	193 017 323	99
167 546 298	153	167 567 202	160	193 017 111	102	193 017 324	99
167 546 299	153	167 567 203	160	193 017 112	102	193 017 325	99
167 546 300	153	167 567 204	160	193 017 113	102	193 017 326	99
167 546 308	155	167 567 205	160	193 017 114	102	193 017 327	99
167 546 309	155	167 567 206	160	193 017 115	102	193 017 355	100
167 546 310	155	167 567 207	160	193 017 116	102	193 017 356	100
167 546 318	155	167 567 208	160	193 017 117	102	193 017 357	100
167 546 319	155	167 567 209	160	193 017 118	102	193 017 358	100
167 546 320	155	167 567 210	160	193 017 119	102	193 017 359	100
167 561 266	163	167 578 002	161	193 017 120	102	193 017 360	100
167 561 267	163	167 578 003	161	193 017 121	102	193 017 361	100
167 561 276	163	167 578 004	161	193 017 122	102	193 017 362	100
167 561 277	163	167 578 005	161	193 017 123	102	193 017 363	100
167 561 282	162	167 578 006	161	193 017 124	102	193 017 364	100
167 561 283	162	167 578 007	161	193 017 125	102	193 017 365	100
167 561 284	162	167 578 008	161	193 017 126	102	193 017 366	100
167 561 285	162	167 578 009	161	193 017 127	102	193 017 367	100
167 561 286	162	167 578 010	161	193 017 155	101	193 017 368	100
167 561 287	162	167 578 022	161	193 017 156	101	193 017 369	100
167 561 288	162	167 578 023	161	193 017 157	101	193 017 370	100
167 561 289	162	167 578 024	161	193 017 158	101	193 017 371	100
167 561 290	162	167 578 025	161	193 017 159	101	193 017 372	100
167 561 292	162	167 578 026	161	193 017 160	101	193 017 373	100
167 561 293	162	167 578 027	161	193 017 161	101	193 017 374	100
167 561 294	162	167 578 028	161	193 017 162	101	193 017 375	100
167 561 295	162	167 578 029	161	193 017 163	101	193 017 376	100
167 561 296	162	167 578 030	161	193 017 164	101	193 017 377	100
167 561 297	162	169 543 302	149	193 017 165	101	193 103 040	90
167 562 266	165	169 543 303	149	193 017 166	101	193 103 042	90
167 562 267	165	169 543 304	149	193 017 167	101	193 103 043	90
167 562 276	165	169 543 305	149	193 017 168	101	193 103 044	90
167 562 277	165	169 543 306	149	193 017 169	101	193 103 045	90
167 562 282	164	169 543 307	149	193 017 170	101	193 103 206	90
167 562 283	164	169 543 322	150	193 017 171	101	193 103 207	90
167 562 284	164	169 543 323	150	193 017 172	101	193 103 208	90
167 562 285	164	169 543 324	150	193 017 173	101	193 103 209	90
167 562 286	164	169 543 325	150	193 017 174	101	193 103 210	90
167 562 287	164	169 543 326	150	193 017 175	101	193 103 211	90
167 562 292	164	169 543 327	150	193 017 176	101	193 103 212	90
167 562 293	164	173 103 056	90	193 017 177	101	193 103 213	90
167 562 294	164	173 103 075	91	193 017 203	102	193 103 214	90
167 562 295	164	173 103 076	91	193 017 204	102	193 104 039	91
167 562 296	164	173 103 077	91	193 017 205	102	193 104 042	91
167 562 297	164	173 103 080	90	193 017 206	102	193 130 037	55
167 567 002	160	173 103 081	93	193 017 207	102	193 130 047	55
167 567 003	160	173 103 082	91	193 017 307	99	193 130 057	55
167 567 004	160	173 103 083	91	193 017 308	99	193 130 067	55
167 567 005	160	173 103 084	91	193 017 309	99	193 130 077	55
167 567 006	160	173 103 105	93	193 017 310	99	193 130 087	55
167 567 007	160	173 103 175	92	193 017 311	99	193 130 097	55
167 567 008	160	173 103 176	92	193 017 312	99	193 130 107	55

Index

Code	Page	Code	Page	Code	Page	Code	Page
193 130 117	55	193 130 737	46	193 131 347	53	193 131 534	44
193 130 127	55	193 130 804	48	193 131 357	53	193 131 535	44
193 130 137	55	193 130 814	47	193 131 377	53	193 131 537	44
193 130 147	55	193 130 824	47	193 131 402	43	193 131 547	44
193 130 157	55	193 130 834	47	193 131 403	43	193 131 557	44
193 130 177	55	193 130 837	48	193 131 404	43	193 131 577	44
193 130 234	54	193 130 844	48	193 131 405	43	193 131 867	44
193 130 237	54	193 130 847	48	193 131 412	40	193 131 877	44
193 130 244	54	193 130 854	48	193 131 413	40	193 131 932	39
193 130 247	54	193 130 857	48	193 131 414	40	193 131 933	39
193 130 254	54	193 130 864	48	193 131 422	40	193 131 934	39
193 130 257	54	193 130 867	48	193 131 423	40	193 131 952	39
193 130 264	54	193 130 874	48	193 131 424	40	193 131 953	39
193 130 267	54	193 130 877	48	193 131 434	40	193 131 954	39
193 130 274	54	193 130 884	48	193 131 437	43	193 131 957	39
193 130 277	54	193 130 887	48	193 131 442	43	193 131 962	39
193 130 284	54	193 130 894	48	193 131 443	43	193 131 963	39
193 130 287	54	193 130 897	48	193 131 444	43	193 131 964	39
193 130 294	54	193 130 904	48	193 131 445	43	193 131 967	39
193 130 297	54	193 130 907	48	193 131 447	43	193 131 972	39
193 130 304	54	193 130 914	48	193 131 452	43	193 131 973	39
193 130 307	54	193 130 917	48	193 131 453	43	193 131 974	39
193 130 314	54	193 130 924	48	193 131 454	43	193 131 977	39
193 130 317	54	193 130 927	48	193 131 455	43	193 131 992	39
193 130 324	54	193 130 934	48	193 131 457	43	193 131 993	39
193 130 327	54	193 130 937	48	193 131 462	43	193 131 994	39
193 130 334	54	193 131 037	34	193 131 463	43	193 131 997	39
193 130 337	54	193 131 047	34	193 131 464	43	193 132 402	41
193 130 347	54	193 131 057	34	193 131 465	43	193 132 403	41
193 130 357	54	193 131 067	34	193 131 467	43	193 132 404	41
193 130 377	54	193 131 077	34	193 131 472	43	193 132 405	41
193 130 432	45	193 131 087	34	193 131 473	43	193 132 412	40
193 130 434	45	193 131 097	34	193 131 474	43	193 132 413	40
193 130 452	45	193 131 107	34	193 131 475	43	193 132 414	40
193 130 454	45	193 131 117	34	193 131 477	43	193 132 422	40
193 130 462	45	193 131 127	34	193 131 482	43	193 132 423	40
193 130 464	45	193 131 137	34	193 131 483	43	193 132 424	40
193 130 472	45	193 131 147	34	193 131 484	43	193 132 435	40
193 130 474	45	193 131 157	34	193 131 485	43	193 132 436	41
193 130 492	45	193 131 177	34	193 131 487	43	193 132 437	41
193 130 494	45	193 131 234	53	193 131 492	43	193 132 442	41
193 130 604	46	193 131 237	53	193 131 493	43	193 132 443	41
193 130 637	46	193 131 244	53	193 131 494	43	193 132 444	41
193 130 644	46	193 131 247	53	193 131 495	43	193 132 445	41
193 130 647	46	193 131 254	53	193 131 497	43	193 132 446	41
193 130 654	46	193 131 257	53	193 131 502	43	193 132 447	41
193 130 657	46	193 131 264	53	193 131 503	43	193 132 452	41
193 130 664	46	193 131 267	53	193 131 504	43	193 132 453	41
193 130 667	46	193 131 274	53	193 131 505	43	193 132 454	41
193 130 674	46	193 131 277	53	193 131 507	43	193 132 455	41
193 130 677	46	193 131 284	53	193 131 512	43	193 132 456	41
193 130 684	46	193 131 287	53	193 131 513	43	193 132 457	41
193 130 687	46	193 131 294	53	193 131 514	43	193 132 462	41
193 130 694	46	193 131 297	53	193 131 515	43	193 132 463	41
193 130 697	46	193 131 304	53	193 131 517	43	193 132 464	41
193 130 704	46	193 131 307	53	193 131 522	43	193 132 465	41
193 130 707	46	193 131 314	53	193 131 523	43	193 132 466	41
193 130 714	46	193 131 317	53	193 131 524	43	193 132 467	41
193 130 717	46	193 131 324	53	193 131 525	43	193 132 472	41
193 130 724	46	193 131 327	53	193 131 527	44	193 132 473	41
193 130 727	46	193 131 334	53	193 131 532	44	193 132 474	41
193 130 734	46	193 131 337	53	193 131 533	44	193 132 475	41

Index

Code	Page	Code	Page	Code	Page	Code	Page
193 132 476	41	193 135 061	59, 208	193 135 746	62	193 155 114	51
193 132 477	41	193 135 069	59, 208	193 135 748	62	193 155 115	51
193 132 482	41	193 135 070	59, 208	193 149 237	55	193 155 116	51
193 132 483	41	193 135 071	59, 208	193 149 247	55	193 155 117	51
193 132 484	41	193 135 079	59, 208	193 149 257	55	193 155 124	51
193 132 485	41	193 135 080	59, 208	193 149 267	55	193 155 125	51
193 132 486	41	193 135 081	59, 208	193 149 277	55	193 155 126	51
193 132 487	41	193 135 159	60, 209	193 149 287	55	193 155 127	51
193 132 492	41	193 135 160	60, 209	193 149 297	55	193 155 134	52
193 132 493	41	193 135 161	60, 209	193 149 307	55	193 155 135	51
193 132 494	41	193 135 202	61	193 149 317	55	193 155 136	51
193 132 495	41	193 135 204	61	193 149 327	55	193 155 137	51
193 132 496	41	193 135 212	61	193 149 337	55	193 155 144	52
193 132 497	41	193 135 214	61	193 149 347	55	193 155 145	52
193 132 502	41	193 135 222	61	193 149 357	55	193 155 146	52
193 132 503	41	193 135 224	61	193 149 377	55	193 155 147	52
193 132 504	41	193 135 232	61	193 149 437	56	193 155 154	52
193 132 505	41	193 135 234	61	193 149 447	56	193 155 155	52
193 132 506	41	193 135 242	61	193 149 457	56	193 155 156	52
193 132 507	41	193 135 244	61	193 149 467	56	193 155 157	52
193 132 512	42	193 135 252	61	193 149 477	56	193 155 234	49
193 132 513	42	193 135 254	61	193 149 487	56	193 155 237	49
193 132 514	42	193 135 262	61	193 149 497	56	193 155 244	49
193 132 515	42	193 135 264	61	193 149 507	56	193 155 247	49
193 132 516	42	193 135 272	61	193 149 517	56	193 155 254	49
193 132 517	42	193 135 274	61	193 149 527	56	193 155 257	49
193 132 522	42	193 135 282	61	193 149 537	56	193 155 264	49
193 132 523	42	193 135 284	61	193 149 547	56	193 155 267	49
193 132 524	42	193 135 289	60, 209	193 149 557	56	193 155 274	49
193 132 525	42	193 135 290	60, 209	193 149 577	56	193 155 277	49
193 132 526	42	193 135 291	60, 209	193 155 034	51	193 155 284	49
193 132 527	42	193 135 294	61	193 155 035	51	193 155 287	49
193 132 532	42	193 135 304	61	193 155 036	51	193 155 294	49
193 132 533	42	193 135 309	60, 209	193 155 037	51	193 155 297	49
193 132 534	42	193 135 310	60, 209	193 155 044	51	193 155 304	49
193 132 535	42	193 135 311	60, 209	193 155 045	51	193 155 307	49
193 132 536	42	193 135 329	60, 209	193 155 046	51	193 155 314	49
193 132 537	42	193 135 330	60, 209	193 155 047	51	193 155 317	49
193 132 544	42	193 135 331	60, 209	193 155 054	51	193 155 324	49
193 132 545	42	193 135 339	60, 209	193 155 055	51	193 155 327	49
193 132 546	42	193 135 340	60, 209	193 155 056	51	193 155 334	50
193 132 547	42	193 135 341	60, 209	193 155 057	51	193 155 337	49
193 132 554	42	193 135 436	61	193 155 064	51	193 155 344	50
193 132 555	42	193 135 446	61	193 155 065	51	193 155 347	50
193 132 556	42	193 135 456	61	193 155 066	51	193 155 354	50
193 132 557	42	193 135 466	61	193 155 067	51	193 155 357	50
193 133 067	34	193 135 476	61	193 155 074	51	193 155 374	50
193 133 097	34	193 135 486	61	193 155 075	51	193 155 377	50
193 135 009	59, 208	193 135 496	61	193 155 076	51	193 280 153	35
193 135 010	59, 208	193 135 506	61	193 155 077	51	193 280 154	35
193 135 019	59, 208	193 135 676	62	193 155 084	51	193 280 184	34
193 135 020	59, 208	193 135 686	62	193 155 085	51	193 280 185	34
193 135 029	59, 208	193 135 696	62	193 155 086	51	193 280 272	36
193 135 030	59, 208	193 135 698	62	193 155 087	51	193 280 273	36
193 135 039	59, 208	193 135 706	62	193 155 094	51	193 280 279	36
193 135 040	59, 208	193 135 708	62	193 155 095	51	193 280 290	34
193 135 041	59, 208	193 135 716	62	193 155 096	51	193 280 294	36
193 135 049	59, 208	193 135 718	62	193 155 097	51	193 280 300	35
193 135 050	59, 208	193 135 726	62	193 155 104	51	193 280 301	35
193 135 051	59, 208	193 135 728	62	193 155 105	51	193 280 358	34
193 135 059	59, 208	193 135 736	62	193 155 106	51	193 280 359	34
193 135 060	59, 208	193 135 738	62	193 155 107	51	193 280 360	34

Index

Code	Page	Code	Page	Code	Page	Code	Page
193 280 711	34	193 480 105	166	700 647 616	119	700 647 678	120
193 280 880	59	193 480 106	166	700 647 617	119	700 647 679	120
193 280 881	59	193 480 107	166	700 647 618	119	700 647 680	120
193 280 951	25	193 480 152	167	700 647 619	119	700 647 681	120
193 280 952	25	193 480 153	167	700 647 620	119	700 647 682	120
193 280 953	25	193 480 154	167	700 647 621	119	700 647 683	120
193 280 958	25	193 480 155	167	700 647 622	119	700 647 684	120
193 280 959	25	193 480 156	167	700 647 623	119	700 647 685	120
193 280 961	23	193 480 157	167	700 647 624	119	700 647 686	120
193 280 963	23	193 480 158	167	700 647 625	119	700 647 687	120
193 280 965	23	193 480 159	167	700 647 626	119	700 647 688	120
193 280 992	25	193 480 160	167	700 647 627	119	700 647 689	120
193 280 993	25	193 480 168	167	700 647 628	119	700 647 690	120
193 280 994	25	193 480 169	167	700 647 629	119	700 647 691	120
193 280 995	25	193 480 170	167	700 647 630	119	700 647 692	120
193 280 996	25	193 480 175	166	700 647 631	119	700 647 693	120
193 280 997	24	193 480 176	166	700 647 632	119	700 647 694	120
193 280 998	23	193 480 177	166	700 647 633	119	700 647 695	120
193 280 999	23	193 480 178	166	700 647 634	119	700 647 696	120
193 281 004	23	193 480 179	166	700 647 635	119	700 647 697	120
193 281 005	23	193 480 180	166	700 647 636	119	700 647 698	120
193 281 006	24	193 480 181	166	700 647 637	119	700 647 699	120
193 281 007	24	316 110 022	203	700 647 638	119	700 647 886	187
193 281 008	24	316 110 039	203	700 647 639	119	700 647 887	187
193 281 009	24	316 125 029	203	700 647 640	119	700 647 888	187
193 281 010	24	316 125 031	203	700 647 641	119	700 647 889	187
193 281 011	24	316 140 018	203	700 647 642	119	700 647 890	187
193 281 012	24	316 140 027	203	700 647 643	119	700 647 891	187
193 281 013	24	316 160 019	203	700 647 644	119	700 647 892	187
193 281 027	59	316 160 020	203	700 647 645	119	700 647 893	187
193 281 030	24	316 180 019	203	700 647 646	119	700 647 894	187
193 281 031	24	316 180 020	203	700 647 647	119	700 647 895	187
193 281 032	23	316 200 012	203	700 647 648	119	700 647 896	187
193 281 033	23	316 200 014	203	700 647 649	119	700 647 897	187
193 281 113	44	316 225 009	203	700 647 650	120	700 647 898	187
193 281 122	45	316 225 010	203	700 647 651	120	700 647 899	187
193 281 152	44	316 250 005	203	700 647 652	120	700 647 900	187
193 281 154	45	316 250 009	203	700 647 653	120	700 647 901	187
193 281 155	45	316 280 019	203	700 647 654	120	700 647 902	187
193 281 156	45	316 280 024	203	700 647 655	120	700 647 903	187
193 281 157	45	316 315 008	203	700 647 656	120	700 647 904	187
193 281 158	45	316 315 009	203	700 647 657	120	700 665 184	121
193 281 159	45	316 355 017	203	700 647 658	120	700 665 185	121
193 281 160	45	316 355 020	203	700 647 659	120	700 665 186	121
193 281 161	45	316 400 008	203	700 647 660	120	700 665 187	121
193 281 162	45	316 400 010	203	700 647 661	120	700 665 188	121
193 281 163	45	700 647 600	119	700 647 662	120	700 665 189	121
193 281 164	45	700 647 601	119	700 647 663	120	700 665 190	121
193 281 435	45	700 647 602	119	700 647 664	120	700 665 191	121
193 281 437	45	700 647 603	119	700 647 665	120	700 665 192	121
193 281 438	45	700 647 604	119	700 647 666	120	700 665 193	121
193 281 439	45	700 647 605	119	700 647 667	120	700 665 194	121
193 281 459	39	700 647 606	119	700 647 668	120	700 665 195	121
193 281 605	35	700 647 607	119	700 647 669	120	700 665 196	121
193 281 606	35	700 647 608	119	700 647 670	120	700 665 197	121
193 281 617	38	700 647 609	119	700 647 671	120	700 665 198	121
193 480 086	166	700 647 610	119	700 647 672	120	700 665 199	121
193 480 087	166	700 647 611	119	700 647 673	120	700 665 200	121
193 480 088	166	700 647 612	119	700 647 674	120	700 665 201	121
193 480 102	166	700 647 613	119	700 647 675	120	700 665 202	121
193 480 103	166	700 647 614	119	700 647 676	120	700 665 203	125
193 480 104	166	700 647 615	119	700 647 677	120	700 665 204	125

Index

Code	Page	Code	Page	Code	Page	Code	Page
700 665 205	125	700 665 432	126	720 100 259	30	720 920 757	28
700 665 206	125	700 665 433	126	720 100 260	30	720 920 758	28
700 665 207	125	700 665 434	126	720 100 261	30	720 920 759	28
700 665 208	125	700 665 435	126	720 100 281	30	720 920 760	28
700 665 209	125	700 665 436	126	720 100 282	30	720 920 761	28
700 665 210	125	700 665 437	126	720 100 283	30	720 920 763	28
700 665 211	125	700 665 438	126	720 100 756	30	720 920 764	28
700 665 212	125	700 665 439	126	720 100 757	30	720 920 765	28
700 665 213	125	700 665 462	125	720 100 758	30	720 920 766	28
700 665 214	125	700 665 463	125	720 100 759	30	720 920 767	28
700 665 215	125	700 665 464	125	720 100 760	30	720 920 768	28
700 665 216	125	700 665 465	125	720 100 761	30	720 920 771	28
700 665 217	125	700 665 466	125	720 100 766	30	720 920 772	28
700 665 218	125	700 665 467	125	720 100 767	30	720 920 773	28
700 665 219	125	700 665 468	125	720 100 771	30	720 920 776	28
700 665 220	125	700 665 469	125	720 100 772	30	720 920 777	28
700 665 221	125	700 665 470	125	720 100 776	30	720 920 778	28
700 665 260	121	700 665 471	125	720 100 777	30	720 920 781	28
700 665 261	121	700 665 472	125	720 100 782	30	720 920 782	28
700 665 262	121	700 665 473	125	720 100 783	30	720 920 783	28
700 665 263	121	700 665 474	125	720 910 007	27	724 100 256	29
700 665 264	121	700 665 475	125	720 910 008	27	724 100 257	29
700 665 265	121	700 665 476	125	720 910 010	27	724 100 258	29
700 665 266	121	701 474 382	186	720 910 011	27	724 100 259	29
700 665 267	121	701 474 383	185	720 910 021	27	724 100 260	29
700 665 268	121	701 474 386	186	720 910 028	27	724 100 261	29
700 665 269	121	701 474 387	186	720 920 007	37	724 100 756	29
700 665 270	121	701 474 388	185	720 920 008	37	724 100 757	29
700 665 271	121	701 474 390	186	720 920 010	37	724 100 758	29
700 665 272	121	701 474 391	186	720 920 011	37	724 100 759	29
700 665 273	121	701 474 392	186	720 920 018	37	724 100 760	29
700 665 274	121	701 474 393	186	720 920 021	37	724 100 761	29
700 665 275	121	701 474 394	186	720 920 208	37	724 100 771	29
700 665 276	121	701 474 395	186	720 920 209	37	724 100 772	29
700 665 277	121	701 474 396	186	720 920 210	37	724 700 319	184
700 665 278	121	701 474 397	186	720 920 211	37	724 700 320	184
700 665 279	124	701 474 398	186	720 920 221	37	724 700 321	184
700 665 280	124	701 474 399	185	720 920 231	37	724 700 322	184
700 665 281	124	701 474 400	185	720 920 241	37	724 700 323	184
700 665 282	124	701 474 401	185	720 920 258	28	724 700 324	184
700 665 283	124	701 480 475	186	720 920 259	28	724 700 325	184
700 665 284	124	701 480 476	186	720 920 260	28	724 700 426	184
700 665 285	124	701 480 477	186	720 920 261	28	724 700 427	184
700 665 286	124	701 480 478	186	720 920 281	28	724 700 428	184
700 665 287	124	701 480 479	186	720 920 282	28	724 700 429	184
700 665 288	124	701 480 480	186	720 920 283	28	724 700 430	184
700 665 289	124	701 480 481	186	720 920 706	37	724 700 431	184
700 665 290	124	701 480 482	186	720 920 707	37	724 700 432	184
700 665 291	124	701 480 483	186	720 920 708	37	724 705 026	184, 185, 186
700 665 292	124	701 480 489	185	720 920 709	37	724 705 130	186
700 665 293	124	701 480 490	185	720 920 710	37	724 705 131	186
700 665 294	124	701 480 491	185	720 920 711	37	724 705 132	186
700 665 295	124	701 480 492	185	720 920 718	37	724 705 133	186
700 665 296	124	701 480 493	185	720 920 719	37	724 705 134	186
700 665 297	124	701 480 494	185	720 920 720	37	724 920 206	38
700 665 425	126	720 100 007	31	720 920 721	37	724 920 207	38
700 665 426	126	720 100 008	31	720 920 728	37	724 920 208	38
700 665 427	126	720 100 010	31	720 920 729	37	724 920 209	38
700 665 428	126	720 100 011	31	720 920 730	37	724 920 210	38
700 665 429	126	720 100 018	31	720 920 731	37	724 920 211	38
700 665 430	126	720 100 021	31	720 920 754	28	724 920 256	27
700 665 431	126	720 100 258	30	720 920 756	28		

Index

Code	Page	Code	Page	Code	Page	Code	Page
724 920 257	27	727 700 718	183	733 150 113	103	733 808 022	179
724 920 258	27	727 700 719	183, 185	733 150 114	103	733 808 023	179
724 920 259	27	727 700 720	183, 185	733 200 106	103	733 808 034	179
724 920 260	27	727 700 721	183	733 200 107	103	733 808 035	179
724 920 261	27	727 700 722	183	733 200 108	103	733 808 036	179
724 920 706	38	727 700 723	183	733 200 109	103	733 808 037	179
724 920 707	38	727 700 724	183	733 200 110	103	733 808 038	179
724 920 708	38	727 700 725	183	733 200 111	103	733 808 039	179
724 920 709	38	727 700 819	192	733 200 112	103	733 808 041	179
724 920 710	38	727 700 820	192	733 200 113	103	733 808 042	179
724 920 711	38	727 701 206	185, 192	733 200 114	103	733 808 045	179
724 920 719	38	727 701 207	185, 192	733 310 006	108	733 808 047	179
724 920 721	38	727 701 208	185, 192	733 310 007	108	733 808 048	179
724 920 756	27	727 701 209	185, 192	733 310 008	108	733 810 106	189
724 920 757	27	727 701 210	185, 192	733 310 009	108	733 810 107	189
724 920 758	27	727 701 211	185, 192	733 310 010	108	733 810 108	189
724 920 759	27	727 701 212	185, 192	733 310 011	108	733 810 109	189
724 920 760	27	727 701 213	192	733 310 036	108	733 810 110	189
724 920 761	27	727 701 214	192	733 310 037	108	733 810 111	189
724 920 771	27	727 701 313	185	733 310 038	108	733 810 112	189
724 920 772	27	727 701 314	185	733 310 039	108	733 810 113	189
727 690 442	129	727 701 321	185	733 310 040	108	733 810 114	189
727 690 443	129	727 701 322	185	733 310 041	108	733 900 006	101
727 700 206	183, 191	727 701 323	185	733 580 106	105	733 900 007	101
727 700 207	183, 191	727 701 324	185	733 580 107	105	733 910 106	104
727 700 208	183, 191	727 701 325	185	733 580 108	105	733 910 107	104
727 700 209	183, 191	727 701 406	183, 192	733 580 109	105	733 910 108	104
727 700 210	183, 191	727 701 407	183, 192	733 580 110	105	733 910 109	104
727 700 211	183, 191	727 701 408	183, 192	733 580 111	105	733 910 110	104
727 700 212	183, 191	727 701 409	183, 192	733 580 206	105	733 910 111	104
727 700 213	191	727 701 410	183, 192	733 580 207	105	733 910 112	104
727 700 214	191	727 701 411	183, 192	733 580 208	105	733 910 113	104
727 700 313	183	727 701 412	183, 192	733 580 209	105	733 910 114	104
727 700 314	183	727 701 413	192	733 580 210	105	733 910 206	107
727 700 315	183	727 701 414	192	733 580 211	105	733 910 207	107
727 700 406	182, 191	727 701 422	192	733 580 706	105	733 910 208	107
727 700 407	182, 191	727 701 423	192	733 580 707	105	733 910 209	107
727 700 408	182, 191	727 701 513	183	733 580 708	105	733 910 210	107
727 700 409	182, 191	727 701 514	183	733 580 709	105	733 910 211	107
727 700 410	182, 191	727 701 521	183	733 580 710	105	733 910 337	104
727 700 411	182, 191	727 701 522	183	733 580 711	105	733 910 341	104
727 700 412	182, 191	727 701 523	183	733 690 406	129	733 910 346	104
727 700 413	191	733 100 106	103	733 690 407	129	733 910 347	104
727 700 414	191	733 100 107	103	733 690 408	129	733 910 348	104
727 700 417	192	733 100 108	103	733 690 409	129	733 910 352	104
727 700 419	192	733 100 109	103	733 690 410	129	733 910 353	104
727 700 420	192	733 100 110	103	733 690 411	129	733 910 358	104
727 700 513	182	733 100 111	103	733 800 009	190	733 910 359	104
727 700 514	182	733 100 112	103	733 800 010	190	733 910 360	104
727 700 515	182	733 100 113	103	733 800 011	190	733 910 361	104
727 700 516	182	733 100 114	103	733 800 012	190	733 910 362	104
727 700 517	182, 183	733 100 206	107	733 800 013	190	733 910 364	104
727 700 518	182	733 100 207	107	733 800 014	190	733 910 370	104
727 700 519	182, 183	733 100 208	107	733 808 009	179	733 910 371	104
727 700 520	182, 183	733 100 209	107	733 808 010	179	733 910 376	104
727 700 521	182	733 150 106	103	733 808 011	179	733 910 434	107
727 700 522	182	733 150 107	103	733 808 012	179	733 910 437	107
727 700 523	182	733 150 108	103	733 808 013	179	733 910 441	107
727 700 524	182	733 150 109	103	733 808 014	179	733 910 446	107
727 700 525	182	733 150 110	103	733 808 016	179	733 910 452	107
727 700 716	183	733 150 111	103	733 808 017	179	733 960 106	104
727 700 717	183, 185	733 150 112	103	733 808 020	179	733 960 107	104

Index

Code	Page	Code	Page	Code	Page	Code	Page
733 960 108	104	748 400 322	196	748 440 715	197	749 440 705	193, 197
733 960 109	104	748 400 323	196	748 440 716	197	749 440 706	193, 194, 197
733 960 110	104	748 400 330	196	748 440 717	197	749 440 707	193, 194, 197
733 960 111	104	748 400 331	196	748 440 719	197	749 440 708	193, 194, 197
733 960 112	104	748 400 332	196	748 440 720	197	749 440 709	193, 194, 197
733 960 113	104	748 400 333	196	748 440 721	197	749 440 710	193, 194, 197
733 960 114	104	748 410 000	106, 194	748 440 722	197	749 440 711	193, 194, 197
734 600 106	106	748 410 001	106, 194	748 440 723	197	749 440 712	193, 194, 197
734 600 107	106	748 410 002	106, 194	748 440 724	197	749 440 713	193, 194, 197
734 600 108	106	748 410 003	106, 194	748 440 725	197	749 440 714	193, 197
734 600 109	106	748 410 004	129	748 440 726	197	749 440 715	197
734 600 110	106	748 410 005	129	748 440 727	197	749 440 716	197
734 600 111	106	748 410 006	129	748 440 728	197	749 440 717	197
745 440 706	194, 197	748 410 007	106, 129, 194	748 440 729	197	749 440 718	197
745 440 707	194, 197	748 410 008	129	749 400 005	195	749 440 719	197
745 440 708	194, 197	748 410 009	129	749 400 006	195	749 440 720	197
745 440 709	194, 197	748 410 010	129	749 400 007	195	749 440 721	197
745 440 710	194, 197	748 410 011	129	749 400 008	195	749 440 722	197
745 440 711	194, 197	748 410 012	106, 194	749 400 009	195	749 440 723	197
745 440 712	194, 197	748 410 012	106, 194	749 400 010	195	749 440 724	197
745 440 713	194, 197	748 410 013	106, 194	749 400 011	195	749 440 725	197
745 440 714	194, 197	748 410 014	106, 129, 194	749 400 012	195	749 440 726	197
745 440 715	197	748 410 015	106, 129, 194	749 400 013	195	749 440 727	197
745 440 716	197	748 410 016	106, 129, 194	749 410 000	106, 194	749 440 728	197
745 440 717	197	748 410 248	129	749 410 001	106, 194	749 440 729	197
745 440 719	197	748 440 502	198	749 410 002	106, 194	749 440 730	197
745 440 720	197	748 440 503	198	749 410 003	106, 194	749 440 731	197
745 440 721	198	748 440 504	198	749 410 004	129	749 440 732	197
745 440 722	198	748 440 505	198	749 410 005	129	749 440 733	197
745 440 723	198	748 440 506	198	749 410 006	129	749 440 734	197
745 440 724	198	748 440 507	198	749 410 007	106, 129, 194	749 440 735	197
745 440 725	198	748 440 508	198	749 410 008	129	753 000 813	69
745 440 726	198	748 440 509	198	749 410 009	129	753 000 814	69
745 440 727	198	748 440 512	198	749 410 010	129	753 000 815	69
745 440 728	198	748 440 515	198	749 410 011	129	753 000 816	69
745 440 729	198	748 440 517	198	749 410 012	106, 194	753 000 817	69
748 400 004	195	748 440 518	198	749 410 013	106, 194	753 000 818	69
748 400 005	195	748 440 519	198	749 410 014	106, 129, 194	753 000 819	69
748 400 006	195	748 440 520	198	749 410 015	106, 129, 194	753 000 820	69
748 400 007	195	748 440 521	198	749 410 016	106, 129, 194	753 000 821	69
748 400 008	195	748 440 522	198	749 410 174	106	753 000 822	69
748 400 009	195	748 440 705	193, 197	749 410 248	129	753 000 823	69
748 400 010	195	748 440 706	193, 194, 197	749 440 502	198	753 000 824	69
748 400 011	195	748 440 707	193, 194, 197	749 440 503	198	753 000 825	69
748 400 012	195	748 440 708	193, 194, 197	749 440 504	198	753 000 826	69
748 400 013	195	748 440 709	193, 194, 197	749 440 505	198	753 000 827	69
748 400 305	193, 196	748 440 710	193, 194, 197	749 440 506	198	753 000 828	69
748 400 306	193, 196	748 440 711	193, 194, 197	749 440 507	198	753 000 829	69
748 400 307	193, 196	748 440 712	193, 194, 197	749 440 508	198	753 000 830	69
748 400 308	193, 196	748 440 713	193, 194, 197	749 440 509	198	753 000 831	69
748 400 309	193, 196	748 440 714	197	749 440 512	198	753 001 008	69
748 400 310	193, 196			749 440 515	198	753 001 009	69
748 400 311	193, 196			749 440 517	198	753 001 010	69
748 400 312	193, 196			749 440 518	198	753 001 011	69
748 400 313	193, 196			749 440 519	198	753 001 012	69
748 400 314	193, 196			749 440 520	198	753 001 013	69
748 400 315	196			749 440 521	198	753 001 014	69
748 400 316	196			749 440 522	198	753 001 015	69
748 400 317	196					753 001 016	69
748 400 319	196					753 001 017	69
748 400 320	196					753 001 018	69
748 400 321	196						

Index

Code	Page	Code	Page	Code	Page	Code	Page
753 001 019	69	753 050 814	72	753 061 015	73	753 080 821	74
753 001 020	69	753 050 815	72	753 061 016	73	753 080 822	74
753 001 021	69	753 050 816	72	753 061 017	73	753 080 823	74
753 001 022	69	753 050 817	72	753 061 018	73	753 080 824	74
753 001 023	69	753 050 818	72	753 061 019	73	753 080 825	74
753 001 024	69	753 050 819	72	753 061 020	73	753 080 826	74
753 001 025	69	753 050 820	72	753 061 021	73	753 080 827	74
753 001 026	69	753 050 821	72	753 061 022	73	753 080 828	74
753 001 027	69	753 050 822	72	753 061 023	73	753 080 829	74
753 001 028	69	753 050 823	72	753 061 024	73	753 081 008	74
753 001 029	69	753 050 824	72	753 061 025	73	753 081 009	74
753 001 030	69	753 050 825	72	753 061 026	73	753 081 010	74
753 001 031	69	753 050 826	72	753 061 027	73	753 081 011	74
753 002 001	70	753 050 827	72	753 061 028	73	753 081 012	74
753 002 002	70	753 050 828	72	753 061 029	73	753 081 013	74
753 002 003	70	753 050 829	72	753 070 813	71	753 081 014	74
753 002 004	70	753 051 008	71	753 070 814	71	753 081 015	74
753 003 001	72	753 051 009	71	753 070 815	71	753 081 016	74
753 003 002	72	753 051 010	71	753 070 816	71	753 081 017	74
753 003 003	72	753 051 011	71	753 070 817	71	753 081 018	74
753 003 004	72	753 051 012	71	753 070 818	71	753 081 019	74
753 018 515	110	753 051 013	71	753 070 819	71	753 081 020	74
753 018 516	110	753 051 014	71	753 070 820	71	753 081 021	74
753 018 517	110	753 051 015	71	753 070 821	71	753 081 022	74
753 018 518	110	753 051 016	71	753 070 822	71	753 081 023	74
753 018 519	110	753 051 017	71	753 070 823	71	753 081 024	74
753 018 520	110	753 051 018	71	753 070 824	71	753 081 025	74
753 018 521	110	753 051 019	71	753 070 825	71	753 081 026	74
753 018 522	110	753 051 020	71	753 070 826	71	753 081 027	74
753 018 523	110	753 051 021	71	753 070 827	71	753 081 028	74
753 018 524	110	753 051 022	71	753 070 828	71	753 081 029	74
753 018 525	110	753 051 023	71	753 070 829	71	753 090 813	75
753 018 526	110	753 051 024	71	753 071 008	70	753 090 814	75
753 018 527	110	753 051 025	71	753 071 009	70	753 090 815	75
753 018 621	110	753 051 026	71	753 071 010	70	753 090 816	75
753 018 622	110	753 051 027	71	753 071 011	70	753 090 817	75
753 018 623	110	753 051 028	71	753 071 012	70	753 090 818	75
753 018 624	110	753 051 029	71	753 071 013	70	753 090 819	75
753 018 625	110	753 060 813	73	753 071 014	70	753 090 820	75
753 018 626	110	753 060 814	73	753 071 015	70	753 090 821	75
753 018 627	110	753 060 815	73	753 071 016	70	753 090 822	75
753 018 635	110	753 060 816	73	753 071 017	70	753 090 823	75
753 018 636	110	753 060 817	73	753 071 018	70	753 090 824	75
753 018 637	110	753 060 818	73	753 071 019	70	753 090 825	75
753 018 638	110	753 060 819	73	753 071 020	70	753 090 826	75
753 018 639	110	753 060 820	73	753 071 021	70	753 090 827	75
753 018 706	110	753 060 821	73	753 071 022	70	753 090 828	75
753 018 707	110	753 060 822	73	753 071 023	70	753 090 829	75
753 018 708	110	753 060 823	73	753 071 024	70	753 091 008	75
753 018 709	110	753 060 824	73	753 071 025	70	753 091 009	75
753 018 710	110	753 060 825	73	753 071 026	70	753 091 010	75
753 018 711	110	753 060 826	73	753 071 027	70	753 091 011	75
753 018 715	110	753 060 827	73	753 071 028	70	753 091 012	75
753 018 716	110	753 060 828	73	753 071 029	70	753 091 013	75
753 018 717	110	753 060 829	73	753 080 813	74	753 091 014	75
753 018 718	110	753 061 008	73	753 080 814	74	753 091 015	75
753 018 719	110	753 061 009	73	753 080 815	74	753 091 016	75
753 018 720	110	753 061 010	73	753 080 816	74	753 091 017	75
753 018 742	110	753 061 011	73	753 080 817	74	753 091 018	75
753 018 743	110	753 061 012	73	753 080 818	74	753 091 019	75
753 018 744	110	753 061 013	73	753 080 819	74	753 091 020	75
753 050 813	72	753 061 014	73	753 080 820	74	753 091 021	75

Index

Code	Page	Code	Page	Code	Page	Code	Page
753 091 022	75	753 120 817	67	753 150 923	66, 205	753 200 801	82
753 091 023	75	753 120 818	67	753 151 006	66	753 200 802	77
753 091 024	75	753 120 819	67	753 151 007	66	753 200 803	77
753 091 025	75	753 120 820	67	753 151 008	66	753 200 808	77
753 091 026	75	753 120 821	67	753 151 009	66	753 200 809	77
753 091 027	75	753 120 822	67	753 151 010	66	753 200 810	82
753 091 028	75	753 120 823	67	753 151 011	66	753 200 811	82
753 091 029	75	753 120 908	67	753 151 012	66	753 200 812	82
753 100 813	65	753 120 909	67	753 151 013	66, 205	753 200 813	77
753 100 814	65	753 120 910	67	753 151 014	66, 205	753 200 814	77
753 100 815	65	753 120 911	67	753 151 015	66, 205	753 200 815	77
753 100 816	65	753 120 912	67	753 151 016	66, 205	753 200 816	77
753 100 817	65	753 120 913	67	753 151 017	66, 205	753 200 817	77
753 100 818	65	753 120 914	67	753 151 018	66, 205	753 200 818	77
753 100 819	65	753 120 915	67	753 151 019	66, 205	753 200 819	77
753 100 820	65	753 120 916	67	753 151 020	66, 205	753 200 820	77
753 100 821	65	753 120 917	67	753 151 021	66, 205	753 200 821	77
753 100 822	65	753 120 918	67	753 151 608	21	753 200 822	82
753 100 823	65	753 120 919	67	753 151 609	21	753 200 823	82
753 100 922	65, 205	753 120 920	67	753 151 610	21	753 200 824	82
753 100 923	65, 205	753 120 921	67	753 151 611	21	753 200 825	82
753 101 001	65, 205	753 120 922	67	753 151 612	21	753 200 826	82
753 101 006	65	753 120 923	67	753 151 813	21	753 200 827	82
753 101 007	65	753 140 813	68	753 151 814	21	753 200 828	81
753 101 008	65	753 140 814	68	753 151 815	21	753 200 829	81
753 101 009	65	753 140 815	68	753 151 817	21	753 200 831	81
753 101 010	65	753 140 816	68	753 151 818	21	753 200 832	81
753 101 011	65	753 140 817	68	753 151 819	22	753 200 833	81
753 101 012	65	753 140 818	68	753 151 820	22	753 200 834	81
753 101 013	65, 205	753 140 819	68	753 151 821	22	753 200 835	81
753 101 014	65, 205	753 140 820	68	753 158 412	111	753 200 836	81
753 101 015	65, 205	753 140 821	68	753 158 413	111	753 200 837	81
753 101 016	65, 205	753 140 822	68	753 158 414	111	753 200 838	81
753 101 017	65, 205	753 140 823	68	753 158 535	111	753 200 839	81
753 101 018	65, 205	753 141 008	68	753 158 536	111	753 200 840	81
753 101 019	65, 205	753 141 009	68	753 158 540	111	753 200 841	81
753 101 020	65, 205	753 141 010	68	753 158 541	111	753 200 842	81
753 101 606	20	753 141 011	68	753 158 542	111	753 200 843	81
753 101 607	20	753 141 012	68	753 158 544	111	753 200 844	81
753 101 608	20	753 141 013	68	753 158 545	111	753 200 845	82
753 101 609	20	753 141 014	68	753 158 606	111	753 200 846	82
753 101 610	20	753 141 015	68	753 158 607	111	753 200 847	82
753 101 611	20	753 141 016	68	753 158 608	111	753 200 848	82
753 101 612	20	753 141 017	68	753 158 609	111	753 200 849	82
753 101 813	20	753 141 018	68	753 158 610	111	753 200 850	82
753 101 814	20	753 141 019	68	753 158 611	111	753 200 851	81
753 101 815	20	753 141 020	68	753 158 612	111	753 200 852	81
753 101 817	20	753 141 021	68	753 158 613	111	753 200 853	81
753 101 818	20	753 141 022	68	753 158 614	111	753 200 854	81
753 101 819	21	753 141 023	68	753 158 615	111	753 200 855	82
753 101 820	21	753 150 813	66	753 158 616	111	753 200 856	82
753 101 821	21	753 150 814	66	753 158 617	111	753 200 857	82
753 108 606	111	753 150 815	66	753 158 619	111	753 200 858	82
753 108 607	111	753 150 816	66	753 158 620	111	753 200 859	82
753 108 608	111	753 150 817	66	753 200 024	76	753 200 860	82
753 108 609	111	753 150 818	66	753 200 025	76	753 200 861	82
753 108 610	111	753 150 819	66	753 200 026	76	753 200 862	82
753 108 611	111	753 150 820	66	753 200 027	76	753 200 863	82
753 120 813	67	753 150 821	66	753 200 124	77	753 200 864	82
753 120 814	67	753 150 822	66	753 200 125	77	753 200 865	82
753 120 815	67	753 150 823	66	753 200 126	77	753 200 866	82
753 120 816	67	753 150 922	66, 205	753 200 127	77	753 200 867	82

Index

Code	Page	Code	Page	Code	Page	Code	Page
753 200 868	82	753 201 075	79	753 201 875	81	753 208 543	113
753 200 869	82	753 201 076	79	753 201 876	81	753 208 544	113
753 200 870	82	753 201 077	80	753 201 878	81	753 208 545	113
753 200 902	76, 206	753 201 078	79	753 201 879	81	753 208 546	113
753 200 903	76, 206	753 201 079	79	753 201 920	77	753 208 547	113
753 200 908	76	753 201 080	80	753 201 921	77	753 208 548	113
753 200 909	76	753 201 081	80	753 202 810	77	753 208 606	112
753 201 001	76, 206	753 201 084	80	753 202 811	77	753 208 607	112
753 201 002	80	753 201 085	80	753 202 812	77	753 208 608	112
753 201 003	80	753 201 086	80	753 202 813	77	753 208 609	112
753 201 004	80	753 201 087	80	753 208 301	113	753 208 610	112
753 201 005	80	753 201 089	80	753 208 302	113	753 208 611	112
753 201 006	76	753 201 090	80	753 208 303	113	753 208 612	112
753 201 007	76	753 201 091	80	753 208 304	113	753 208 613	112
753 201 008	76	753 201 092	80	753 208 305	113	753 208 614	112
753 201 009	76	753 201 093	80	753 208 307	113	753 208 615	112
753 201 010	76	753 201 094	80	753 208 308	113	753 208 616	112
753 201 011	76	753 201 095	80	753 208 309	113	753 208 617	112
753 201 012	76	753 201 096	80	753 208 310	113	753 208 619	112
753 201 013	76, 206	753 201 097	80	753 208 311	113	753 208 620	112
753 201 014	76, 206	753 201 098	80	753 208 312	113	753 208 624	112
753 201 015	76, 206	753 201 099	80	753 208 313	113	753 208 625	112
753 201 016	76, 206	753 201 100	80	753 208 314	113	753 208 626	112
753 201 017	76, 206	753 201 101	80	753 208 321	113	753 208 627	112
753 201 018	76, 206	753 201 102	80	753 208 322	113	753 208 668	112
753 201 019	76, 206	753 201 103	80	753 208 323	113	753 208 671	112
753 201 020	76, 206	753 201 104	80	753 208 324	113	753 208 672	112
753 201 021	79	753 201 105	80	753 208 338	113	753 208 673	112
753 201 022	79	753 201 106	80	753 208 339	113	753 211 034	23
753 201 023	79	753 201 107	80	753 208 341	113	753 211 035	23
753 201 024	79	753 201 108	80	753 208 351	112	753 211 037	23
753 201 025	79	753 201 109	80	753 208 352	112	753 211 039	23
753 201 026	79	753 201 110	80	753 208 353	112	753 211 040	23
753 201 027	79	753 201 111	80	753 208 354	112	753 211 059	23
753 201 028	79	753 201 112	80	753 208 355	112	753 211 060	23
753 201 029	79	753 201 113	80	753 208 357	112	753 211 063	23
753 201 031	79	753 201 114	80	753 208 358	112	753 211 069	23
753 201 032	79	753 201 115	80	753 208 359	112	753 211 070	23
753 201 033	79	753 201 120	76	753 208 360	112	753 211 073	23
753 201 034	79	753 201 121	76	753 208 361	112	753 211 080	23
753 201 035	79	753 201 606	24	753 208 362	112	753 211 083	23
753 201 036	79	753 201 607	24	753 208 363	112	753 211 606	22
753 201 037	79	753 201 608	24	753 208 364	112	753 211 607	22
753 201 038	79	753 201 609	24	753 208 371	112	753 211 608	22
753 201 039	79	753 201 610	24	753 208 372	112	753 211 609	22
753 201 040	79	753 201 611	24	753 208 373	112	753 211 610	22
753 201 041	79	753 201 613	24	753 208 374	112	753 211 611	22
753 201 042	79	753 201 614	24	753 208 388	112	753 211 612	22
753 201 043	79	753 201 615	24	753 208 389	112	753 221 031	112
753 201 048	79	753 201 617	24	753 208 391	112	753 221 032	112
753 201 049	79	753 201 618	24	753 208 412	113	753 251 010	78
753 201 050	79	753 201 813	22	753 208 413	113	753 251 011	78
753 201 051	79	753 201 814	22	753 208 414	113	753 251 012	78
753 201 052	79	753 201 815	22	753 208 524	113	753 251 013	78
753 201 053	79	753 201 817	22	753 208 525	113	753 251 014	78
753 201 054	79	753 201 818	22	753 208 526	113	753 251 044	83
753 201 055	79	753 201 819	23	753 208 527	113	753 251 063	78
753 201 069	80	753 201 820	23	753 208 535	113	753 251 064	78
753 201 070	80	753 201 821	23	753 208 536	113	753 314 000	123
753 201 072	80	753 201 827	81	753 208 540	113	753 314 001	123
753 201 073	79	753 201 873	81	753 208 541	113	753 314 002	123
753 201 074	79	753 201 874	81	753 208 542	113	753 318 006	124

Index

Code	Page	Code	Page	Code	Page	Code	Page
753 318 007	124	753 648 612	127	753 790 208	189	753 798 858	177
753 318 008	124	753 648 613	127	753 790 209	189	753 798 859	177
753 318 009	124	753 648 614	127	753 790 210	189	753 798 860	177
753 318 010	124	753 665 558	109	753 790 211	189	753 798 861	177
753 318 011	124	753 665 559	109	753 790 212	189	753 798 862	177
753 318 036	124	753 665 560	109	753 790 213	189	753 798 863	177
753 318 037	124	753 665 561	109	753 790 214	189	753 798 924	178
753 318 038	124	753 665 562	109	753 798 210	177	753 798 925	178
753 318 039	124	753 665 563	109	753 798 211	177	753 798 926	178
753 318 040	124	753 665 564	109	753 798 212	177	753 798 927	178
753 318 041	124	753 665 565	109	753 798 213	177	753 798 951	178
753 508 606	127	753 665 566	109	753 798 214	177	753 798 952	178
753 508 607	127	753 665 567	109	753 798 215	177	753 800 006	171
753 508 608	127	753 665 568	109	753 798 216	177	753 800 007	171
753 508 609	127	753 665 569	109	753 798 217	177	753 800 008	171
753 508 610	127	753 665 570	109	753 798 218	177	753 800 009	171
753 508 611	127	753 665 571	109	753 798 219	177	753 800 010	171
753 508 616	127	753 665 572	109	753 798 220	177	753 800 011	171
753 508 617	127	753 665 573	109	753 798 221	177	753 800 012	171
753 508 618	127	753 665 574	109	753 798 222	177	753 800 013	171, 206
753 508 619	127	753 665 575	109	753 798 223	177	753 800 014	171, 206
753 508 620	127	753 665 576	109	753 798 224	177	753 800 015	171, 206
753 508 621	127	753 665 577	109	753 798 225	177	753 800 016	171, 206
753 518 412	128	753 665 578	109	753 798 226	177	753 800 017	171, 206
753 518 413	128	753 665 579	109	753 798 227	177	753 800 018	171, 206
753 518 414	128	753 665 580	109	753 798 306	175	753 800 019	171, 206
753 518 606	126	753 665 581	109	753 798 307	175	753 800 020	171, 206
753 518 607	126	753 665 582	109	753 798 308	175	753 800 021	171, 206
753 518 608	126	753 665 583	109	753 798 309	175	753 800 022	171, 206
753 518 609	126	753 665 584	109	753 798 310	175	753 800 023	171, 206
753 518 610	126	753 665 585	109	753 798 311	175	753 800 028	171
753 518 611	126	753 665 586	109	753 798 312	175	753 800 029	171
753 518 612	126	753 665 587	109	753 798 313	175	753 800 030	171
753 518 613	126	753 665 588	109	753 798 314	175	753 800 033	171
753 518 614	126	753 665 589	109	753 798 315	175	753 800 085	173
753 528 412	128	753 665 590	109	753 798 316	175	753 800 086	173
753 528 413	128	753 665 591	109	753 798 317	175	753 800 087	173
753 528 414	128	753 665 592	109	753 798 318	175	753 800 088	173
753 528 606	126	753 665 593	109	753 798 319	175	753 800 089	173
753 528 607	126	753 665 594	109	753 798 320	175	753 800 090	173
753 528 608	126	753 665 595	109	753 798 321	175	753 800 091	173
753 528 609	126	753 700 611	187	753 798 322	175	753 800 092	173
753 528 610	126	753 700 612	187	753 798 323	175	753 800 093	173
753 528 611	126	753 700 613	187	753 798 324	175	753 800 094	173
753 528 612	126	753 700 614	187	753 798 325	175	753 800 095	173
753 528 613	126	753 700 615	187	753 798 326	175	753 800 096	173
753 528 614	126	753 700 616	187	753 798 327	175	753 800 097	173
753 608 412	128	753 700 617	187	753 798 728	178	753 800 098	173
753 608 413	128	753 700 618	187	753 798 729	178	753 800 103	173
753 608 414	128	753 700 619	187	753 798 730	178	753 800 104	173
753 608 612	127	753 700 620	187	753 798 731	178	753 800 105	173
753 608 613	127	753 700 621	187	753 798 753	178	753 800 106	173
753 608 614	127	753 700 622	187	753 798 754	178	753 800 107	173
753 648 412	128	753 700 623	187	753 798 755	178	753 800 108	173
753 648 413	128	753 700 624	187	753 798 756	178	753 800 224	171, 206
753 648 414	128	753 700 625	187	753 798 757	178	753 800 225	171, 206
753 648 606	127	753 700 626	187	753 798 758	178	753 800 226	171, 206
753 648 607	127	753 700 627	187	753 798 759	178	753 800 227	171, 206
753 648 608	127	753 700 628	187	753 798 833	175	753 800 299	173
753 648 609	127	753 700 629	187	753 798 834	175	753 800 300	173
753 648 610	127	753 790 206	189	753 798 835	175	753 800 301	173
753 648 611	127	753 790 207	189	753 798 836	175	753 800 302	173

Index

Code	Page	Code	Page	Code	Page	Code	Page
753 900 001	114	753 900 840	87	753 901 042	84	753 901 832	25
753 900 002	114	753 900 841	87	753 901 043	85	753 901 833	25
753 900 004	114	753 900 842	87	753 901 044	85	753 901 836	25
753 900 007	114	753 900 843	87	753 901 045	85	753 901 837	25
753 900 011	114	753 900 844	87	753 901 046	84	753 901 838	25
753 900 012	114	753 900 866	86	753 901 047	84	753 901 839	25
753 900 013	114	753 900 867	86	753 901 048	84	753 901 840	25
753 900 014	114	753 900 868	86	753 901 049	85	753 901 841	25
753 900 015	114	753 900 870	86	753 901 050	85	753 901 842	25
753 900 016	114	753 900 872	86	753 901 052	84	753 901 845	25
753 900 017	114	753 900 873	86	753 901 053	84	753 901 864	25
753 900 018	114	753 900 874	86	753 901 054	84	753 901 865	25
753 900 019	115	753 900 875	86	753 901 055	84	753 902 801	116
753 900 020	115	753 900 876	86	753 901 058	84	753 902 802	116
753 900 021	115	753 900 877	86	753 901 059	84	753 902 804	116
753 900 022	115	753 900 880	86	753 901 060	84	753 902 807	116
753 900 023	115	753 900 881	86	753 901 063	84	753 902 811	116
753 900 025	115	753 900 882	86	753 901 064	84	753 902 812	116
753 900 026	115	753 900 884	86	753 901 065	84	753 902 813	116
753 900 027	115	753 900 885	86	753 901 066	84, 207	753 902 814	116
753 900 035	115	753 900 886	86	753 901 067	84, 207	753 902 815	116
753 900 036	115	753 900 887	86	753 901 068	84, 207	753 902 816	116
753 900 037	115	753 900 888	86	753 901 070	84	753 902 817	116
753 900 800	86	753 900 889	86	753 901 071	84	753 902 818	116
753 900 801	86	753 900 890	86	753 901 072	84	753 902 819	116
753 900 802	86	753 900 891	86	753 901 073	84, 207	753 902 820	116
753 900 803	86	753 900 892	86	753 901 074	84, 207	753 902 821	116
753 900 804	86	753 900 893	86	753 901 075	84, 207	753 902 822	116
753 900 805	86	753 900 894	86	753 901 076	84, 207	753 902 823	116
753 900 806	86	753 900 895	86	753 901 077	84	753 902 824	116
753 900 807	86	753 900 896	86	753 901 078	84	753 902 825	116
753 900 808	86	753 900 898	86	753 901 080	84, 207	753 902 826	116
753 900 809	86	753 900 899	86	753 901 081	84, 207	753 902 827	116
753 900 810	86	753 901 000	84, 207	753 901 082	84	753 902 828	117
753 900 811	86	753 901 001	84, 207	753 901 083	84	753 902 829	117
753 900 812	86	753 901 002	84, 207	753 901 084	84, 207	753 902 830	117
753 900 813	86	753 901 003	84, 207	753 901 085	84, 207	753 902 831	117
753 900 814	86	753 901 004	84, 207	753 901 086	84	753 902 832	117
753 900 815	86	753 901 005	85, 207	753 901 087	84, 207	753 902 833	117
753 900 816	86	753 901 012	85, 207	753 901 088	84, 207	753 902 834	117
753 900 817	86	753 901 013	85, 207	753 901 089	84, 207	753 902 835	117
753 900 818	86	753 901 014	85, 207	753 901 090	84, 207	753 902 836	117
753 900 819	86	753 901 015	85, 207	753 901 091	84, 207	753 902 837	117
753 900 820	86	753 901 016	85	753 901 092	84, 207	753 902 838	117
753 900 821	86	753 901 017	85	753 901 094	84, 207	753 902 839	117
753 900 822	86	753 901 018	85, 207	753 901 095	84, 207	753 902 840	117
753 900 823	86	753 901 019	85	753 901 096	84, 207	753 902 841	117
753 900 824	86	753 901 020	85	753 901 097	84, 207	753 902 842	117
753 900 825	86	753 901 022	85	753 901 098	84, 207	753 902 843	117
753 900 826	86	753 901 024	85	753 901 099	84, 207	753 902 844	117
753 900 827	86	753 901 025	85	753 901 639	24	753 902 845	117
753 900 828	87	753 901 026	85	753 901 640	24	753 902 846	117
753 900 829	87	753 901 027	85	753 901 641	24	753 908 464	116
753 900 831	86	753 901 029	85	753 901 644	24	753 908 465	116
753 900 832	86	753 901 030	85	753 901 645	24	753 908 470	116
753 900 833	87	753 901 032	84, 207	753 901 646	24	753 908 471	116
753 900 834	87	753 901 033	84, 207	753 901 651	24	753 908 472	116
753 900 835	87	753 901 034	84, 207	753 901 652	24	753 908 476	116
753 900 836	87	753 901 038	84	753 901 656	24	753 908 477	116
753 900 837	87	753 901 039	85	753 901 657	24	753 908 637	114
753 900 838	87	753 901 040	85	753 901 658	24	753 908 641	114
753 900 839	87	753 901 041	84	753 901 831	25	753 908 642	114

Index

Code	Page	Code	Page	Code	Page	Code	Page
753 908 646	114	753 908 978	116	753 909 888	118	753 911 809	19
753 908 647	114	753 908 979	116	753 909 889	118	753 911 810	19
753 908 648	114	753 908 981	116	753 909 890	118	753 911 811	19
753 908 652	114	753 908 985	116	753 909 891	118	753 911 817	19
753 908 653	114	753 908 999	116	753 909 892	118	753 911 818	19
753 908 654	114	753 909 809	115	753 909 893	118	753 911 819	19
753 908 658	114	753 909 810	115	753 909 894	118	753 911 820	19
753 908 659	114	753 909 811	115	753 909 895	118	753 911 821	19
753 908 660	114	753 909 812	115	753 909 896	118	753 911 822	19
753 908 664	114	753 909 816	115	753 910 266	122	753 911 823	19
753 908 665	114	753 909 817	115	753 910 267	122	753 911 852	19
753 908 666	114	753 909 818	115	753 910 268	122	753 911 853	19
753 908 670	114	753 909 819	115	753 910 269	122	753 911 854	19
753 908 671	114	753 909 820	115	753 910 270	122	753 911 950	20
753 908 672	114	753 909 822	115	753 910 271	122	753 911 951	20
753 908 676	114	753 909 823	115	753 910 556	122	753 911 952	20
753 908 677	114	753 909 824	115	753 910 557	122	753 911 953	20
753 908 680	114	753 909 825	115	753 910 558	122	753 911 954	20
753 908 684	114	753 909 826	115	753 910 559	122	753 914 266	122
753 908 685	114	753 909 827	115	753 910 560	122	753 914 267	122
753 908 688	114	753 909 829	115	753 910 561	122	753 914 268	122
753 908 690	114	753 909 830	115	753 910 906	108	753 914 269	122
753 908 692	114	753 909 831	115	753 910 907	108	753 914 270	122
753 908 695	114	753 909 832	115	753 910 908	108	753 914 271	122
753 908 696	114	753 909 833	115	753 910 909	108	753 960 406	108
753 908 697	114	753 909 834	115	753 910 910	108	753 960 407	108
753 908 877	114	753 909 835	115	753 910 911	108	753 960 408	108
753 908 878	114	753 909 836	115	753 910 912	108	753 960 409	108
753 908 879	114	753 909 837	115	753 910 913	108	753 960 410	108
753 908 880	114	753 909 838	115	753 910 914	108	753 960 411	108
753 908 881	114	753 909 839	115	753 911 606	17	753 960 611	188
753 908 883	114	753 909 840	115	753 911 607	17	753 960 612	188
753 908 885	114	753 909 841	115	753 911 608	17	753 960 613	188
753 908 887	114	753 909 842	115	753 911 609	17	753 960 614	188
753 908 890	114	753 909 843	115	753 911 610	17	753 960 615	188
753 908 891	114	753 909 844	115	753 911 611	17	753 960 616	188
753 908 892	114	753 909 845	115	753 911 612	17	753 960 617	188
753 908 895	114	753 909 846	115	753 911 613	17, 204	753 960 618	188
753 908 896	114	753 909 859	118	753 911 614	17, 204	753 960 619	188
753 908 897	114	753 909 860	118	753 911 615	17, 204	753 960 620	188
753 908 904	116	753 909 861	118	753 911 616	17, 204	753 960 621	188
753 908 912	116	753 909 862	118	753 911 617	17, 204	753 960 622	188
753 908 916	116	753 909 866	118	753 911 618	17, 204	753 960 623	188
753 908 917	116	753 909 867	118	753 911 619	17, 204	753 960 624	188
753 908 920	116	753 909 868	118	753 911 620	17, 204	753 960 625	188
753 908 922	116	753 909 869	118	753 911 621	17, 204	753 960 626	188
753 908 926	116	753 909 870	118	753 911 622	17, 204	753 960 627	188
753 908 927	116	753 909 872	118	753 911 623	17, 204	753 960 628	188
753 908 928	116	753 909 873	118	753 911 652	18	753 960 629	188
753 908 931	116	753 909 874	118	753 911 704	18, 205	753 960 810	88
753 908 932	116	753 909 875	118	753 911 705	18, 205	753 960 811	88
753 908 933	116	753 909 876	118	753 911 706	18, 205	753 960 812	88
753 908 937	116	753 909 877	118	753 911 707	18, 205	753 960 813	88
753 908 938	116	753 909 879	118	753 911 708	18	753 960 814	88
753 908 939	116	753 909 880	118	753 911 709	18	753 960 815	88
753 908 943	116	753 909 881	118	753 911 710	18	753 960 816	88
753 908 944	116	753 909 882	118	753 911 711	18	753 960 817	88
753 908 949	116	753 909 883	118	753 911 804	19	753 960 818	88
753 908 950	116	753 909 884	118	753 911 805	19	753 960 819	88
753 908 975	116	753 909 885	118	753 911 806	19	753 960 820	88
753 908 976	116	753 909 886	118	753 911 807	19	753 960 821	88
753 908 977	116	753 909 887	118	753 911 808	19	753 960 822	88

Index

Code	Page	Code	Page	Code	Page
753 960 823	88	775 641 510	31	800 000 145	136
753 960 824	88	775 641 514	31	800 000 146	136
753 960 825	88	775 641 518	31	800 000 147	136
753 960 826	88	775 641 524	31	800 000 152	136
753 960 827	88	775 641 632	31	800 000 153	136
753 960 828	88	775 641 636	31	800 000 154	136
753 960 829	88	775 641 640	31	800 000 155	136
753 960 830	88	775 641 641	31	800 000 156	136
753 960 831	88	775 641 645	31	800 000 157	136
753 960 832	88	775 641 655	31	800 000 218	138
753 960 833	88	775 641 659	31	800 000 219	138
753 960 922	87, 208	775 642 664	31	800 000 220	138
753 960 923	87, 208	775 642 665	31	800 000 228	138
753 960 924	87, 208	775 642 666	31	800 000 229	138
753 960 925	87, 208	775 642 669	31	800 000 230	138
753 960 926	87, 208	775 642 672	31	800 000 282	137
753 960 927	87, 208	775 642 673	31	800 000 283	137
753 960 928	87	775 642 675	31	800 000 284	137
753 960 929	87	775 642 678	31	800 000 285	137
753 961 006	87	799 100 061	57	800 000 286	137
753 961 007	87	799 100 062	57	800 000 287	137
753 961 008	87	799 150 378	57	800 000 288	137
753 961 009	87	799 198 079	57	800 000 289	137
753 961 010	87	799 198 080	57	800 000 290	137
753 961 011	87	799 198 091	57	800 000 292	137
753 961 012	87	799 199 282	57	800 000 293	137
753 961 013	87, 208	799 199 283	57	800 000 294	137
753 961 014	87, 208	799 199 286	57	800 000 295	137
753 961 015	87, 208	799 199 287	57, 63	800 000 296	137
753 961 016	87, 208	799 199 288	63	800 000 297	137
753 961 017	87, 208	799 199 289	63	800 000 298	137
753 961 018	87, 208	799 199 321	63	800 000 299	137
753 961 019	87, 208	799 199 322	63	800 000 300	137
753 961 020	87, 208	799 199 323	63	800 015 141	148
753 961 021	87, 208	799 199 327	63	800 015 142	148
753 961 606	26	799 199 328	63	800 015 143	148
753 961 607	26	799 298 023	32	800 015 179	148
753 961 608	26	799 350 364	32	800 024 832	148
753 961 609	26	799 496 011	32	800 024 834	148
753 961 610	26	800 000 101	135	800 045 326	148
753 961 611	26	800 000 102	135	800 045 327	148
753 961 617	26	800 000 103	135	800 045 328	148
753 961 619	26	800 000 104	135	800 050 308	145
753 961 620	26	800 000 105	135	800 050 344	145
753 961 621	26	800 000 106	135	800 050 345	145
753 961 712	26	800 000 107	135	800 050 346	145
753 961 713	26	800 000 111	135	800 050 347	145
753 961 714	26	800 000 112	135	800 050 348	145
753 961 715	26	800 000 113	135	800 050 837	145
753 961 716	26	800 000 114	135	800 050 838	145
753 961 717	26	800 000 115	135	800 050 839	145
753 961 718	26	800 000 116	135		
753 961 719	26	800 000 117	135		
753 961 720	26	800 000 125	138		
753 968 606	123	800 000 126	138		
753 968 607	123	800 000 127	138		
753 968 608	123	800 000 135	138		
753 968 609	123	800 000 136	138		
753 968 610	123	800 000 137	138		
753 968 611	123	800 000 142	136		
775 641 502	31	800 000 143	136		
775 641 507	31	800 000 144	136		

General Condition of Supply of Georg Fischer Piping Systems Limited, Schaffhausen

1 General

- 1.1 These General Conditions shall apply to all Products supplied by Georg Fischer Piping Systems Limited («Georg Fischer») to the Purchaser.
They shall also apply to all future business even when no express reference is made to them.
- 1.2 Any deviating or supplementary conditions especially Purchaser's general conditions of purchase and verbal agreements shall only be applicable if accepted in writing by Georg Fischer.
- 1.3 The written form shall be deemed to be fulfilled by all forms of transmission, evidenced in the form of text, such as telefax, e-mail, etc.

2 Tenders

- Tenders shall only be binding if they contain a specifically stated period for acceptance.

3 Scope of Delivery

- 3.1 Georg Fischer's product range is subject to change.
- 3.2 The confirmation of order shall govern the scope and execution of the contract.

4 Data and Documents

- 4.1 Technical documents such as drawings, descriptions, illustrations and data on dimensions, performance and weight as well as the reference to standards are for information purposes only. They are not warranted characteristics and are subject to change.
- 4.2 All technical documents shall remain the exclusive property of Georg Fischer and may only be used for the agreed purposes or as Georg Fischer may consent.

5 Confidentiality, Protection of Personal Data

- 5.1 Each party shall keep in strict confidence all commercial or technical information relating to the business of the other party, of which it has gained knowledge in the course of its dealing with the other party. Such information shall neither be disclosed to third parties nor used for other purposes than those for which the information has been supplied.
- 5.2 In the context of the contractual relation with the Purchaser personal data may be processed. The Purchaser agrees to the disclosure of said data to third parties such as foreign subcontractors and suppliers etc.

6 Local Laws and Regulations, Export Controls

- 6.1 The Purchaser shall bring to the attention of Georg Fischer all local laws and regulations at the place of destination which bear connection with the execution of the contract and the adherence to relevant safety regulations and approval procedures.
- 6.2 In case of re-exports, Purchaser shall be responsible for compliance with pertinent export control regulations.

7 Price

- 7.1 Unless agreed otherwise, the prices shall be deemed quoted net ex works (according to Incoterms 2010 of the ICC, or latest version) including standard packing. All supplementary costs such as the cost of carriage, insurance, export-, transit- and import- licences etc. shall be borne by the Purchaser. The Purchaser shall also bear the costs of all taxes, fees, duties etc. connected with the contract.
- 7.2 If the costs of packing, carriage, insurance, fees and other supplementary costs are included in the tender price or contract price or are referred to specifically in the tender or confirmation of order, Georg Fischer reserve the right to revise their prices accordingly should any change occur in the relevant tariffs.

8 Terms of Payment

- 8.1 The Purchaser shall make payment in the manner agreed by the parties without any deductions such as discounts, costs, taxes or dues.
- 8.2 The Purchaser may only withhold or off-set payments due against counter claims which are either expressly acknowledged by Georg Fischer or finally awarded to the Purchaser.
In particular, payment shall still be made when unessential items are still outstanding provided that the Products already delivered are not rendered unusable as a result.

9 Retention of Title

- 9.1 The Products shall remain the property of Georg Fischer until the Purchaser shall have settled all claims, present and future, which Georg Fischer may have against him.
- 9.2 Should the Purchaser resell Products to which title is reserved, in the ordinary course of business, he shall hereby be deemed to have tacitly assigned to Georg Fischer the proceeds deriving from their sale together with all collateral rights, securities and reservations of title until all claims held by Georg Fischer shall have been settled. Until revoked by Georg Fischer, this assignment shall not preclude Purchaser's right to collect the assigned receivables.
- 9.3 To the extent the value of the Products to which title is reserved together with collateral securities exceeds Georg Fischer's claims against the Purchaser by more than 20%, Georg Fischer shall re-assign the above proceeds to Purchaser at his request.

10 Delivery

- 10.1 The term of delivery shall commence as soon as the contract has been entered into, all official formalities such as import and payment permits have been obtained and all essential technical issues have been settled. The term of delivery shall be deemed duly observed when, upon its expiry, the Products are ready for despatch.
- 10.2 Delivery is subject to the following conditions, i.e. the term of delivery shall be reasonably extended:
 - a) if Georg Fischer are not supplied in time with the information necessary for the execution of the contract or if subsequent changes causing delays are made by the Purchaser.
 - b) if Georg Fischer are prevented from performing the contract by force majeure. Force majeure shall equally be deemed to be any unforeseeable event beyond Georg Fischer's control which renders Georg Fischer's performance commercially impractical or impossible, such as delayed or defective supplies from sub contractors labour disputes, governmental orders or regulations, shortages in materials or energy, serious disturbances in Georg Fischer's works, such as the total or partial destruction of plant and equipment or the breakdown of essential facilities, serious disruptions in transport facilities, e.g. impassable roads.
Should the effect of force majeure exceed a period of six (6) months, either party may cancel the contract forthwith.
Georg Fischer shall not be liable for any damage or loss of any kind whatsoever resulting from the reform, any suspension or cancellation being without prejudice to Georg Fischer's right to recover all sums due in respect of consignments delivered and costs incurred to date.
 - c) if the Purchaser is in delay with the fulfilment of his obligations under the contract, in particular, if he does not adhere to the agreed conditions of payment or if he has failed to timely provide the agreed securities.
- 10.3 If for reasons attributable to Georg Fischer the agreed term of delivery or a reasonable extension thereof is exceeded, Georg Fischer shall not be deemed in default until the Purchaser has granted to Georg Fischer in writing a reasonable extension thereof of not less than one (1) month which equally is not met.
The Purchaser shall then be entitled to the remedies provided at law, it being however understood that, subject to limitations of Art. 16, damage claims shall be limited to max. 10% of the price of the delayed delivery.
- 10.4 Part shipments shall be allowed and Georg Fischer shall be entitled to invoice for such partial deliveries.
- 10.5 If the Purchaser fails to take delivery within a reasonable time of Products notified as ready for despatch, Georg Fischer shall be entitled to store the Products at the Purchaser's expense and risk and to invoice them as delivered. If Purchaser fails to effect payment, Georg Fischer shall be entitled to dispose of the Products.
- 10.6 Should Purchaser cancel an order without justification and should Georg Fischer not insist on the performance of the contract, Georg Fischer shall be entitled to a penalty amounting to 10% of the contract price, Georg Fischer's right to prove and claim higher damages remaining reserved.

Purchaser shall be entitled to prove, that Georg Fischer has suffered no or a considerably lower damage than the penalty forfeited.

11 Packing

If the Products are provided with additional packing over and above the standard packing, such packing shall be charged additionally.

12 Passing of Risk

- 12.1 The risk in the Products shall pass to the Purchaser as soon as they have left Georg Fischer's works (EX WORKS, Incoterms 2010 ICC, or latest version), even if delivery is made carriage-paid, under similar clauses or including installation or when carriage is organized and managed by Georg Fischer.
- 12.2 If delivery is delayed for reasons beyond Georg Fischer's control, the risk shall pass to the Purchaser when he is notified that the Products are ready for despatch.

13 Carriage and Insurance

- 13.1 Unless agreed otherwise, the Purchaser shall bear the cost of carriage.
 - 13.2 The Purchaser shall be responsible for transport insurance against damage of whatever kind. Even when such insurance is arranged by Georg Fischer it shall be deemed taken out by the order of and for the account of the Purchaser and at his risk.
 - 13.3 Special requests regarding carriage and insurance shall be communicated to Georg Fischer in due time. Otherwise carriage shall be arranged by Georg Fischer at their discretion, but without responsibility, by the quickest and cheapest method possible.
In case of carriage-paid delivery transport arrangements shall be made by Georg Fischer. If the Purchaser specifies particular requirements, any extra costs involved shall be borne by him.
 - 13.4 In the event of damage or loss of the Products during carriage the Purchaser shall mark the delivery documents accordingly and immediately have the damage ascertained by the carrier. Not readily ascertainable damages sustained during carriage shall be notified to the carrier within six (6) days after receipt of the Products.
- ## 14 Inspection, Notification of Defects and Damages
- 14.1 The Products will be subject to normal inspection by Georg Fischer during manufacture. Additional tests required by the Purchaser shall be agreed upon in writing and shall be charged to the Purchaser.
 - 14.2 It shall be a condition of Georg Fischer's obligation under the warranties stated hereinafter that Georg Fischer be notified in writing by the Purchaser of any purported defect immediately upon discovery. Notice concerning weight, numbers or apparent defects is to be given latest within 30 days from receipt of the Products, notice of other defects immediately latest within seven (7) working days after discovery, in any event within the agreed warranty period.
 - 14.3 Purchaser shall not dispose of allegedly defective Products until all warranty and/or damage claims are finally settled. At its request, defective Products are to be placed at Georg Fischer's disposal.
 - 14.4 At its request, Georg Fischer shall be given the opportunity to inspect the defect and/or damage, prior to commencement of remedial work, either itself or by third party experts.

15 Warranty

- 15.1 At the written request of the Purchaser, Georg Fischer undertakes to repair or replace at its discretion, as quickly as possible and free of charge, all Products supplied which demonstrably suffer from faulty design, materials or workmanship, from faulty operating or installation instructions or which become defective or unusable due to faulty advice.
In order to protect employees from toxic or radioactive substances which may have been transported through defective parts returned to Georg Fischer's sales organisation, said parts must be accompanied by a Material Safety Disclosure Form. The form may be obtained from Georg Fischer's local sales company or via www.piping.georgfischer.com.
Replaced parts shall become property of Georg Fischer, unless Georg Fischer waives such claim.
- 15.2 For Products which are manufactured to specifications, drawings or patterns supplied by the Purchaser, Georg Fischer's warranty shall be restricted to proper materials and workmanship.
- 15.3 The Purchaser shall be entitled to rescind the contract or to demand a reduction of the contract price if
 - the repair or replacement of the defective Product is impossible
 - the defective Product is not repaired or replaced within a reasonable period
 - Georg Fischer refuses the repair or replacement or if for reasons attributable to Georg Fischer the repair or replacement is delayed.
- 15.4 For Products or essential components manufactured by a third party and supplied by Georg Fischer under this contract, Georg Fischer's warranty is limited to the warranty provided by said third party.
- 15.5 This warranty shall not apply to damage resulting from normal wear and tear, improper storage and maintenance, failure to observe the operating instructions, overstressing or overloading, unsuitable operating media, unsuitable construction work or unsuitable building ground, improper repairs or alterations by the Purchaser or third parties, the use of other than original spare parts and other reasons beyond Georg Fischer's control.
- 15.6 No action or claim may be brought by the Purchaser on account of any alleged breach of warranty or any other obligation of Georg Fischer after the expiration of twelve (12) months from receipt of the Products by the end user or at the latest within eighteen (18) months of the Products being despatched by Georg Fischer.
- 15.7 In case of Products for use in domestic installations or in utilities
 - Georg Fischer will assume the costs of dismantling the defective Product and restoring the damaged object up to CHF 1'000'000 per occurrence.
 - warranty or damage claims - contrary to Section 15.6 - are time-barred five (5) years from the date of installation or seven (7) years from the production date, whichever is earlier.

16 Limitation of Liability

The rights and remedies of the customer shall be exclusively governed by these General Conditions of Supply and shall be in lieu of any remedies at law. All further claims for damages, reduction of the purchase price, termination of or rescission of the contract are excluded. In no case whatsoever shall the customer be entitled to claim damages other than compensation for costs of remedying defects in the supplies. This in particular refers, but shall not be limited, to loss of production, loss of use, loss of orders, loss of profit, third party recovery claims and other direct or indirect or consequential damages.
This limitation of liability equally applies to the extent Georg Fischer is liable for acts or omissions of its employees or third parties engaged for the performance of its obligations. It does not apply in case of unlawful intent or gross negligence on the part of Georg Fischer's management and in case of Georg Fischer's statutory liability, in particular under applicable product liability laws.

17 Severability

Should any term or clause of these General Conditions in whole or in part be found to be unenforceable or void, all other provisions shall remain in full force and effect and the unenforceable or void provision shall be replaced by a valid provision, which comes closest to the original intention of the unenforceable or invalid provision.

18 Place of Performance and Jurisdiction

- 18.1 Place of performance for the Products shall be the Georg Fischer works from which the Products are despatched.
- 18.2 The contract shall be governed by Swiss law without regard to conflict of law provisions that would require the application of another law.
- 18.3 Any civil action based upon any alleged breach of this contract shall be filed and prosecuted exclusively in the courts of Schaffhausen, Switzerland.
Georg Fischer however reserves the right to file actions in any court having jurisdiction over controversies arising out of or in connection with the present contract.

Worldwide at home

Our sales companies and representatives ensure local customer support in more than 100 countries.

www.gfps.com

Argentina / Southern South America

Georg Fischer Central Plastics Sudamérica S.R.L.
Buenos Aires / Argentina
Phone +54 11 4512 02 90
gfcentral.ps.ar@georgfischer.com
www.gfps.com/ar

Australia

George Fischer Pty Ltd
Riverwood NSW 2210
Phone +61 (0) 2 9502 8000
australia.ps@georgfischer.com
www.gfps.com/au

Austria

Georg Fischer Rohrleitungssysteme GmbH
3130 Herzogenburg
Phone +43 (0) 2782 856 43-0
austria.ps@georgfischer.com
www.gfps.com/at

Belgium / Luxembourg

Georg Fischer NV/SA
1600 Sint-Pieters-Leeuw / Belgium
Phone +32 (0) 2 556 40 20
Fax +32 (0) 2 524 34 26
be.ps@georgfischer.com
www.gfps.com/be

Brazil

Georg Fischer Sist. de Tub. Ltda.
04571-020 São Paulo/SP
Phone +55 (0) 11 5525 1311
br.ps@georgfischer.com
www.gfps.com/br

Canada

Georg Fischer Piping Systems Ltd
Mississauga, ON L5T 2B2
Phone +1 (905) 670 8005
Fax +1 (905) 670 8513
ca.ps@georgfischer.com
www.gfps.com/ca

China

Georg Fischer Piping Systems Ltd
Shanghai 201319
Phone +86 21 3899 3899
china.ps@georgfischer.com
www.gfps.com/cn

Denmark / Iceland

Georg Fischer A/S
2630 Taastrup / Denmark
Phone +45 (0) 70 22 19 75
info.dk.ps@georgfischer.com
www.gfps.com/dk

Finland

Georg Fischer AB
01510 Vantaa
Phone +358 (0) 9 586 58 25
Fax +358 (0) 9 586 58 29
info.fi.ps@georgfischer.com
www.gfps.com/fi

France

Georg Fischer SAS
95932 Roissy Charles de Gaulle Cedex
Phone +33 (0) 1 41 84 68 84
fr.ps@georgfischer.com
www.gfps.com/fr

Germany

Georg Fischer GmbH
73095 Albershausen
Phone +49 (0) 7161 302 0
info.de.ps@georgfischer.com
www.gfps.com/de

India

Georg Fischer Piping Systems Pvt. Ltd
400 083 Mumbai
Phone +91 22 4007 2000
Fax +91 22 4007 2020
branchoffice@georgfischer.com
www.gfps.com/in

Indonesia

PT Georg Fischer Indonesia
Karawang 41371, Jawa Barat
Phone +62 267 432 044
Fax +62 267 431 857
indonesia.ps@georgfischer.com
www.gfps.com/id

Italy

Georg Fischer S.p.A.
20063 Cernusco S/N (MI)
Phone +39 02 921 861
it.ps@georgfischer.com
www.gfps.com/it

Japan

Georg Fischer Ltd
530-0003 Osaka
Phone +81 (0) 6 6341 2451
jp.ps@georgfischer.com
www.gfps.com/jp

Korea

Georg Fischer Korea Co. Ltd
Unit 2501, U-Tower
120 Heungdeok Jungang-ro
(Yeongdeok-dong)
Giheung-gu, Yongin-si, Gyeonggi-do
Phone +82 31 8017 1450
Fax +82 31 217 1454
kor.ps@georgfischer.com
www.gfps.com/kr

Malaysia

George Fischer (M) Sdn. Bhd.
41200 Klang, Selangor Darul Ehsan
Phone +60 (0) 3 3122 5585
Fax +60 (0) 3 3122 5575
my.ps@georgfischer.com
www.gfps.com/my

Mexico / Northern Latin America

Georg Fischer S.A. de C.V.
CP 66636 Apodaca, Nuevo Leon / Mexico
Phone +52 (81) 1340 8586
Fax +52 (81) 1522 8906
mx.ps@georgfischer.com
www.gfps.com/mx

Middle East

Georg Fischer Piping Systems (Switzerland) Ltd
Dubai / United Arab Emirates
Phone +971 4 289 49 60
gcc.ps@georgfischer.com
www.gfps.com/int

Netherlands

Georg Fischer N.V.
8161 PA Epe
Phone +31 (0) 578 678 222
nl.ps@georgfischer.com
www.gfps.com/nl

New Zealand

Georg Fischer Ltd
5018 Upper Hutt
Phone +04 527 9813
Fax +04 527 9834
nz.ps@georgfischer.com
www.gfps.com/nz

Norway

Georg Fischer AS
1351 Rud
Phone +47 67 18 29 00
no.ps@georgfischer.com
www.gfps.com/no

Philippines

George Fischer Pte Ltd
Representative Office
1604 Pasig City
Phone +632 571 2365
Fax +632 571 2368
sgp.ps@georgfischer.com
www.gfps.com/sg

Poland

Georg Fischer Sp. z o.o.
05-090 Sekocin Nowy
Phone +48 (0) 22 31 31 0 50
poland.ps@georgfischer.com
www.gfps.com/pl

Romania

Georg Fischer Piping Systems (Switzerland) Ltd
020257 Bucharest - Sector 2
Phone +40 (0) 21 230 53 80
ro.ps@georgfischer.com
www.gfps.com/int

Russia

Georg Fischer Piping Systems (Switzerland) Ltd
Moscow 125040
Phone +7 495 748 11 44
ru.ps@georgfischer.com
www.gfps.com/ru

Singapore

Georg Fischer Pte Ltd
528 872 Singapore
Phone +65 6747 0611
Fax +65 6747 0577
sgp.ps@georgfischer.com
www.gfps.com/sg

Spain / Portugal

Georg Fischer S.A.
28046 Madrid / Spain
Phone +34 (0) 91 781 98 90
es.ps@georgfischer.com
www.gfps.com/es

Sweden

Georg Fischer AB
117 43 Stockholm
Phone +46 (0) 8 506 775 00
info.se.ps@georgfischer.com
www.gfps.com/se

Switzerland

Georg Fischer Rohrleitungssysteme (Schweiz) AG
8201 Schaffhausen
Phone +41 (0) 52 631 3026
ch.ps@georgfischer.com
www.gfps.com/ch

Taiwan

Georg Fischer Co. Ltd
San Chung Dist., New Taipei City
Phone +886 2 8512 2822
Fax +886 2 8512 2823
www.gfps.com/tw

United Kingdom / Ireland

Georg Fischer Sales Limited
Coventry, CV2 2ST / United Kingdom
Phone +44 (0) 2476 535 535
uk.ps@georgfischer.com
www.gfps.com/uk

USA / Caribbean

Georg Fischer LLC
92618 Irvine, CA / USA
Phone +1 714 731 8800
Fax +1 714 731 6201
us.ps@georgfischer.com
www.gfps.com/us

Vietnam

Georg Fischer Pte Ltd
Representative Office
Ho Chi Minh City
Phone +84 28 3948 4000
Fax +84 28 3948 4010
sgp.ps@georgfischer.com
www.gfps.com/vn

International

Georg Fischer Piping Systems (Switzerland) Ltd
8201 Schaffhausen / Switzerland
Phone +41 (0) 52 631 3003
Fax +41 (0) 52 631 2893
info.export@georgfischer.com
www.gfps.com/int

The information and technical data (altogether "Data") herein are not binding, unless explicitly confirmed in writing. The Data neither constitutes any expressed, implied or warranted characteristics, nor guaranteed properties or a guaranteed durability. All Data is subject to modification. The General Terms and Conditions of Sale of Georg Fischer Piping Systems apply.